

A guidebook intended for use by first responders
during the initial phase of a transportation incident
involving hazardous materials/dangerous goods

2024

EMERGENCY RESPONSE GUIDEBOOK



U.S. Department
of Transportation
**Pipeline and
Hazardous Materials
Safety Administration**



Transport
Canada

Transports
Canada



COMUNICACIONES
SECRETARÍA DE INFRAESTRUCTURA, COMUNICACIONES Y TRANSPORTES

SHIPPING PAPERS (DOCUMENTS)

For the purpose of this guidebook, shipping documents and shipping papers are synonymous. Shipping papers provide vital information regarding the hazardous materials/dangerous goods to initiate protective actions. A consolidated version of the information found on shipping papers may be found as follows:

- Road – kept in the cab of a motor vehicle
- Rail – kept in possession of a crew member
- Aviation – kept in possession of the pilot or aircraft employees
- Marine – kept in a holder on the bridge of a vessel

Information provided:

- 4-digit identification number, UN or NA (go to yellow section)
- Proper shipping name (go to blue section)
- Hazard class or division number of material
- Packing group
- Emergency response telephone number
- Information describing the hazards of the material (entered on or attached to the shipping paper)*

EMERGENCY CONTACT 1-000-000-0000	EXAMPLE OF EMERGENCY CONTACT TELEPHONE NUMBER
CONTRACT #: XX-XXXX-X **	HAZARD CLASS OR DIVISION NO.
UN1219	ISOPROPANOL
3	II
12 000 LITERS	1 TANKTRUCK
ID NUMBER	SHIPPING NAME
	PACKING GROUP

EXAMPLE OF PLACARD AND PANEL WITH ID NUMBER

The 4-digit ID Number may be shown on the diamond-shaped placard or on an adjacent orange panel displayed on the ends and sides of a cargo tank, vehicle or rail car.



A Numbered Placard

OR

A Placard and an Orange Panel



1219

* In the United States, this requirement may be satisfied by attaching a guide from the ERG2024 to the shipping paper, or by having the entire guidebook available for reference.

** In the United States, a registration or contract number may be required on a shipping paper.

HOW TO USE THIS GUIDEBOOK

RESIST RUSHING IN!

**APPROACH INCIDENT FROM UPWIND, AND UPHILL AND/OR UPSTREAM
STAY CLEAR OF ALL SPILLS, VAPORS, FUMES, SMOKE, AND POTENTIAL HAZARDS**

WARNING: DO NOT USE THIS FLOWCHART if more than one hazardous material/dangerous good is involved. Immediately call the appropriate emergency response agency telephone number listed on the inside back cover of this guidebook. For chemical or biological warfare agents, refer to the "Criminal or Terrorist Use of Chemical, Biological and Radiological Agents" section.

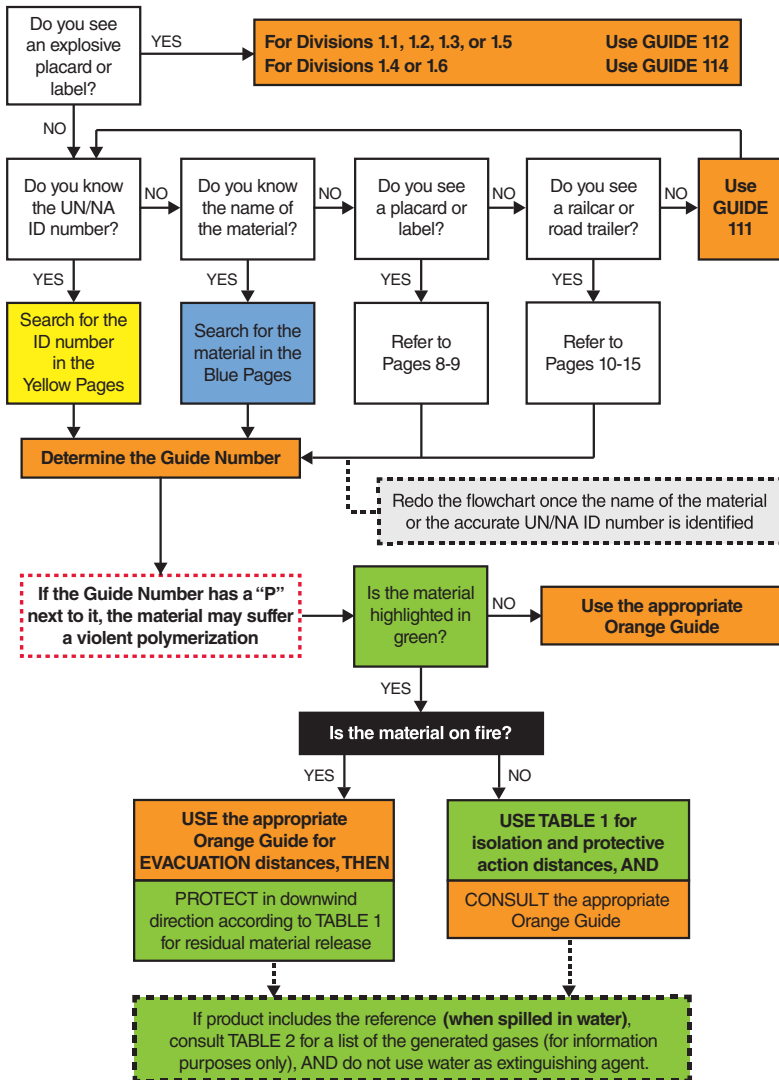

BEFORE AN EMERGENCY - BECOME FAMILIAR WITH THIS GUIDEBOOK!

First responders must be trained in the use of this guidebook.

LOCAL EMERGENCY TELEPHONE NUMBERS

Please populate this section with emergency telephone numbers
for local assistance:

HAZMAT CONTRACTORS

RAIL COMPANIES

FEDERAL/STATE/PROVINCIAL AGENCIES

OTHERS

TABLE OF CONTENTS

Shipping Papers (Documents)	Inside front cover
How to Use this Guidebook	1
Local Emergency Telephone Numbers	2
Safety Precautions	4
Notification and Request for Technical Information	5
Hazard Classification System	6
Introduction to the Table of Markings, Labels and Placards	7
Table of Markings, Labels and Placards and Initial Response Guide to Use On-scene	8
Rail Car Identification Chart	10
Road Trailer Identification Chart	13
Globally Harmonized System of Classification and Labeling of Chemicals (GHS)	16
Hazard Identification Numbers Displayed on Some Intermodal Containers	18
Pipeline Transportation	22
ID Number Index (yellow section)	28
Name of Material Index (blue section)	88
How to Use the Orange Guides	148
General First Aid	150
Guides (orange section)	152
Introduction to Green Tables	280
Protective Actions	283
Protective Action Decision Factors to Consider	284
Background on Table 1 – Initial Isolation and Protective Action Distances	286
Table 1 – Initial Isolation and Protective Action Distances	288
Table 2 – Water-Reactive Materials which Produce Toxic Gases	334
Table 3 – Initial Isolation and Protective Action Distances for Large Spills for Different Quantities of Six Common TIH (PIH in the US) Gases	340
ERG2024 User's Guide	344
Protective Clothing	350
Decontamination	352
Fire and Spill Control	353
Considerations for Lithium Battery and Electric Vehicle (EV) Fires	356
BLEVE and Heat Induced Tear	357
BLEVE – Safety Precautions	358
Criminal or Terrorist Use of Chemical, Biological and Radiological Agents	360
Improvised Explosive Device (IED) Safe Stand-Off Distance	367
Glossary	369
Publication Data	380
Canada and United States National Response Centers	384
ERAP – Emergency Response Assistance Plans	385
24-Hour Emergency Response Telephone Numbers	388

SAFETY PRECAUTIONS

RESIST RUSHING IN!

APPROACH CAUTIOUSLY FROM UPWIND, UPHILL AND/OR UPSTREAM:

- Stay clear of *Vapor, Fumes, Smoke and Spills*.
- Keep vehicle at a safe distance from the scene.

SECURE THE SCENE:

- Isolate the area and protect yourself and others.

IDENTIFY THE HAZARDS USING ANY OF THE FOLLOWING:

- Placards
- Container labels
- Shipping papers
- Rail Car and Road Trailer Identification Chart
- Safety Data Sheets (SDS)
- Knowledge of persons on scene
- Consult applicable orange guide

ASSESS THE SITUATION:

- Is there a fire, a spill or a leak?
- What are the weather conditions?
- What is the terrain like?
- Who/what is at risk: people, property or the environment?
- What actions should be taken – evacuation, shelter-in-place or dike?
- What resources (human and equipment) are required?
- What can be done immediately?

OBTAIN HELP:

- Advise your headquarters to notify responsible agencies and call for assistance from qualified personnel.

RESPOND:

- Enter only when wearing appropriate protective gear.
- Rescue attempts and protecting property must be weighed against you becoming part of the problem.
- Establish a command post and lines of communication.
- Continually reassess the situation and modify response accordingly.
- Consider safety of people in the immediate area first, including your own safety.

ABOVE ALL: Do not assume that gases or vapors are harmless because of lack of a smell – odorless gases or vapors may be harmful. Use **CAUTION** when handling empty containers because they may still present hazards until they are cleaned and purged of all residues.

NOTIFICATION AND REQUEST FOR TECHNICAL INFORMATION

Follow the steps outlined in your organization's standard operating procedures and/or local emergency response plan for obtaining qualified assistance. Generally, the notification sequence and requests for technical information beyond what is available in this guidebook should occur in the following order:

1. NOTIFY YOUR ORGANIZATION/AGENCY

- Based on information provided, this will set in motion a series of events. Actions may range from dispatching additional trained personnel to the scene, to activating the local emergency response plan.
- Ensure that local fire and police departments have been notified.

2. CALL THE EMERGENCY RESPONSE TELEPHONE NUMBER ON THE SHIPPING PAPER

- If shipping paper is not available, use guidance under next section "**NATIONAL ASSISTANCE**".

3. NATIONAL ASSISTANCE

- Contact the appropriate emergency response agency listed on the inside back cover of this guidebook.
- Provide as much information about the hazardous material/dangerous good and the nature of the incident.
- The agency will provide immediate advice on handling the early stages of the incident.
- The agency will also contact the shipper or manufacturer of the material for more detailed information if necessary.
- The agency will request on-scene assistance when necessary.

4. PROVIDE AS MUCH OF THE FOLLOWING INFORMATION AS POSSIBLE:

- Your name, call-back telephone number, fax number
- Location and nature of problem (spill, fire, etc.)
- Name and identification number of material(s) involved
- Shipper/consignee/point-of-origin
- Carrier name, rail car or truck number
- Container type and size
- Quantity of material transported/released
- Local conditions (weather, terrain)
- Proximity to schools, hospitals, waterways, etc.
- Injuries and exposures
- Local emergency services that have been notified

HAZARD CLASSIFICATION SYSTEM

The hazard class of hazardous materials/dangerous goods is indicated either by its class (or division) number or name. Placards are used to identify the class or division of a material. The hazard class or division number must be displayed in the lower corner of a placard and is required for both primary and subsidiary hazard classes and divisions, if applicable. For other than Class 7 placards, text indicating a hazard (for example, "CORROSIVE") is not required. Text is shown only in the U.S. The hazard class or division number and subsidiary hazard classes or division numbers placed in parentheses (when applicable), must appear on the shipping paper after each proper shipping name.

Class 1 - Explosives

Division 1.1	Explosives which have a mass explosion hazard
Division 1.2	Explosives which have a projection hazard but not a mass explosion hazard
Division 1.3	Explosives which have a fire hazard and either a minor blast hazard or a minor projection hazard or both, but not a mass explosion hazard
Division 1.4	Explosives which present no significant hazard
Division 1.5	Very insensitive explosives with a mass explosion hazard
Division 1.6	Extremely insensitive articles which do not have a mass explosion hazard

Class 2 - Gases

Division 2.1	Flammable gases
Division 2.2	Non-flammable, non-toxic* gases
Division 2.3	Toxic* gases

Class 3 - Flammable liquids (and Combustible liquids [U.S.]

Class 4 - Flammable solids; Substances liable to spontaneous combustion; Substances which, on contact with water, emit flammable gases

Division 4.1	Flammable solids, self-reactive substances and solid desensitized explosives
Division 4.2	Substances liable to spontaneous combustion
Division 4.3	Substances which in contact with water emit flammable gases

Class 5 - Oxidizing substances and Organic peroxides

Division 5.1	Oxidizing substances
Division 5.2	Organic peroxides

Class 6 - Toxic* substances and Infectious substances

Division 6.1	Toxic* substances
Division 6.2	Infectious substances

Class 7 - Radioactive materials

Class 8 - Corrosive substances

Class 9 - Miscellaneous hazardous materials/dangerous goods and articles

* The words "poison" or "poisonous" are synonymous with the word "toxic".

INTRODUCTION TO THE TABLE OF MARKINGS, LABELS AND PLACARDS

USE THIS TABLE ONLY WHEN THE ID NUMBER OR PROPER SHIPPING NAME IS NOT AVAILABLE.

This section displays the placards used on transport vehicles carrying hazardous materials/dangerous goods with the applicable reference GUIDE circled. Follow these steps:

- 1. Approach scene from upwind, uphill and/or upstream at a safe distance to safely identify and/or read the placard or orange panel. Use binoculars if available.**
- 2. Match the vehicle placard(s) with one of the placards displayed in this section.**
- 3. Consult the circled guide number associated with the placard. Use that guide information for now. For example:**

- Use GUIDE **127** for a FLAMMABLE (Class 3) placard



- Use GUIDE **153** for a CORROSIVE (Class 8) placard



- Use GUIDE **111** when the DANGER or DANGEROUS placard is displayed or the nature of the spilled, leaking or burning material is not known. Also use this GUIDE when the presence of hazardous materials/dangerous goods is suspected but no placards can be seen.

If multiple placards point to more than one guide, initially use the most conservative guide (i.e., the guide requiring the greatest degree of protective actions).

- 4. Guides associated with the placards provide the most significant risk and/or hazard information.**
- 5. When specific information, such as ID number or proper shipping name, becomes available, the more specific Guide recommended for that material must be consulted.**
- 6. A single asterisk (*) on orange placards represents an explosive's compatibility group letter. The asterisk must be replaced with the appropriate compatibility group letter. Refer to the "Glossary" section.**
- 7. Double asterisks (**) on orange placards represent the division of the explosive. The double asterisks must be replaced with the appropriate division number.**

TABLE OF MARKINGS, LABELS AND PLACARDS

USE THIS TABLE ONLY IF MATERIALS CANNOT BE SPECIFICALLY IDENTIFIED BY

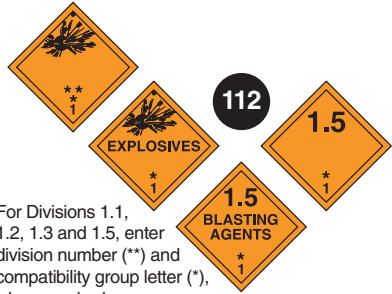
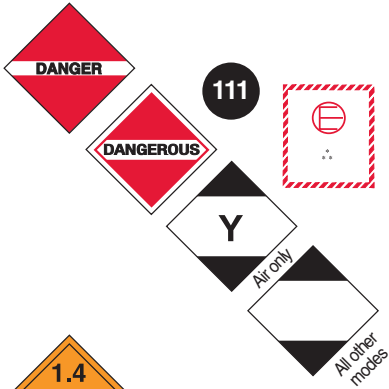

For Divisions 1.1, 1.2, 1.3 and 1.5, enter division number (**) and compatibility group letter (*), when required.



For Divisions 1.4 and 1.6, enter compatibility group letter (*), when required.

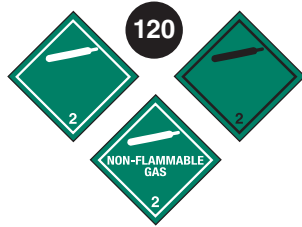

INHALATION HAZARD

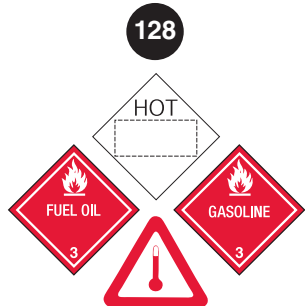

AND INITIAL RESPONSE GUIDE TO USE ON-SCENE

USING THE SHIPPING PAPER, NUMBERED PLACARD, OR ORANGE PANEL NUMBER



134



136



139

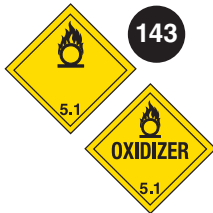

143

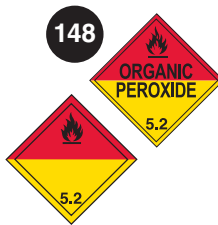

148



153

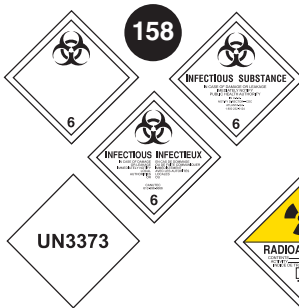

158

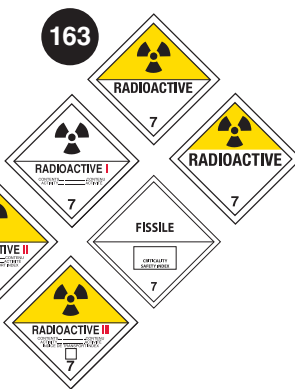

163

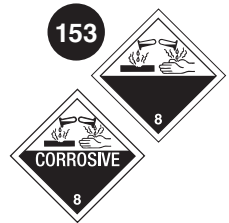

153



138

Lithium metal batteries
(UN3090, UN3091)

147

Lithium ion batteries
(UN3480, UN3481)



171

RAIL CAR IDENTIFICATION CHART

CAUTION: Emergency response personnel must be aware that rail tank cars vary widely in construction, fittings and purpose. Tank cars could transport products that may be solids, liquids or gases. The products may be under pressure. It is essential that products be identified by consulting shipping papers or train consist or contacting dispatch centers before emergency response is initiated. The information stenciled on the sides or ends of tank cars, as illustrated below, may be used to identify the product utilizing:

- a. the commodity name shown;
- b. the other information shown, especially reporting marks and car number which, when supplied to a dispatch center, will facilitate the identification of the product.

The recommended guides should be considered as last resort if the material cannot be identified by any other means.

117 Pressure tank car

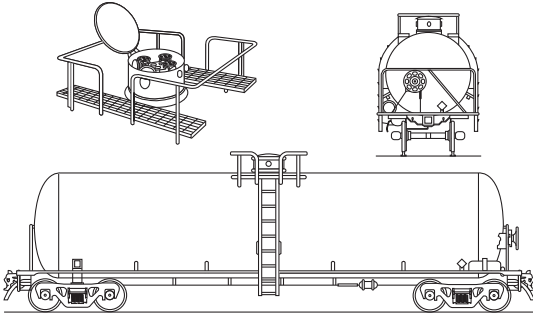

- For flammable, non-flammable, toxic and/or liquefied compressed gases
- Protective housing
- No bottom fittings
- Pressures usually above 40 psi

131 Non-pressure / low pressure tank car

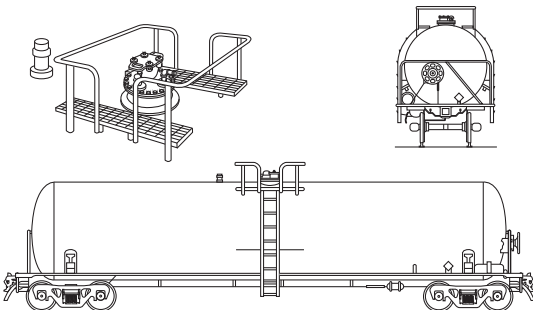

- Known as **general service tank car**
- For variety of hazardous and non-hazardous materials
- Fittings and valves normally visible at the top of the tank
- Some may have bottom outlet valve
- Pressures usually below 25 psi

RAIL CAR IDENTIFICATION CHART

128 Non-pressure / low pressure tank car (TC117, DOT117)

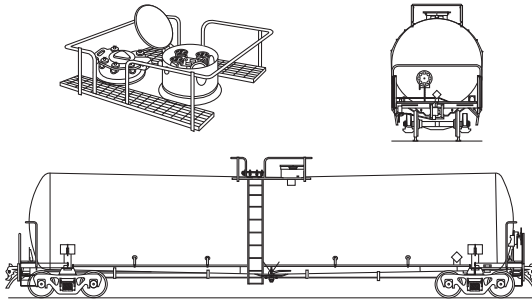

- For flammable liquids (e.g., petroleum crude oil, ethanol)
- Protective housing separate from manway
- Bottom outlet valve
- Pressures usually below 25 psi

115 Cryogenic tank car

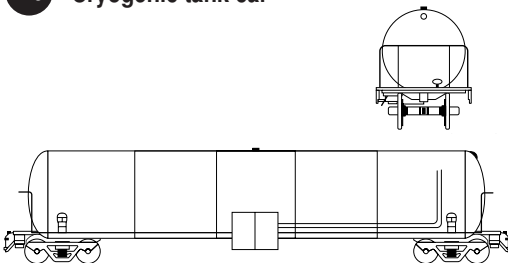

- For refrigerated liquefied gases (cryogenic liquids)
- Vacuum-insulated railcars (tank within a tank)
- Fittings compartment located in a cabinet at ground level of the tank
- Pressures range from 10 - 75 psi

RAIL CAR IDENTIFICATION CHART

111 Box car

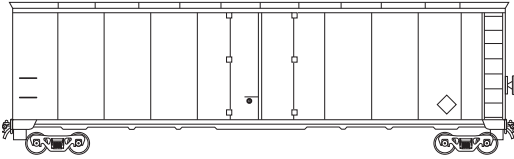

- For general freight that carry bulk or non-bulk packages
- May transport hazardous materials/dangerous goods in small packages or "totes"
- Single or double sliding door

140 Hopper car

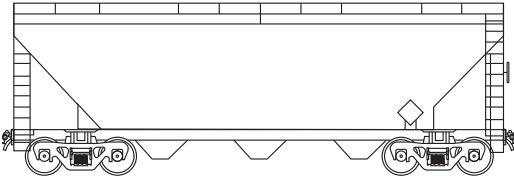

- For bulk commodities and bulk cargo (e.g., coal, ore, cement and solid granular materials)
- Bulk lading discharged by gravity through the hopper bottom doors when doors opened

COMMON MARKINGS ON RAIL CARS: reporting marks and car number, load limit (pounds or kilograms), empty weight of car, placard, tank qualification and pressure relief device information, car specification, and commodity name.

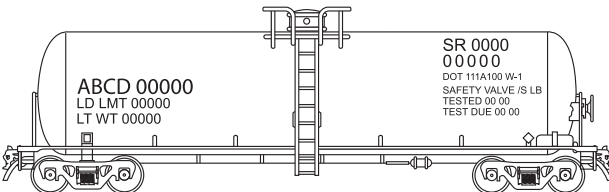

ROAD TRAILER IDENTIFICATION CHART

CAUTION: This chart depicts only the most general shapes of road trailers and cargo transport units. Emergency response personnel must be aware that there are many variations of road trailers, not illustrated below, that are used for shipping chemical products. Many intermodal tanks that transport liquids, solids, liquefied compressed gases, and refrigerated liquefied gases have similar silhouettes. The suggested guides are for the most hazardous products that may be transported in these trailer types.

WARNING: Road trailers may be jacketed, the cross-section may look different than shown and external ring stiffeners would be invisible.

NOTE: An emergency shut-off valve is commonly found at the front of the tank, near the driver door.

The recommended guides should be considered as last resort if the material cannot be identified by any other means.

MAWP: Maximum Allowable Working Pressure.

117 MC331, TC331, SCT331

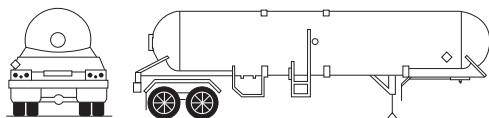

- For liquefied compressed gases (e.g., LPG, ammonia)
- Rounded heads
- Design pressure between 100-500 psi
- Different configurations exist

117 MC338, TC338, SCT338, TC341, CGA341

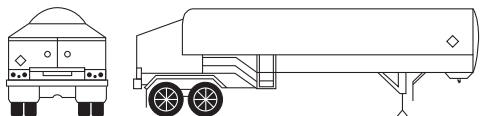

- For refrigerated liquefied gases (cryogenic liquids)
- Similar to a "giant thermo-bottle"
- Fittings compartment located in a cabinet at the rear of the tank
- MAWP between 25-500 psi

137 DOT407, TC407, SCT307, MC307, TC307

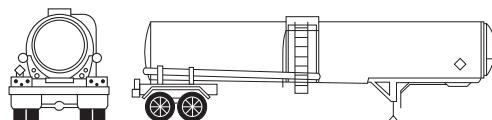

- For toxic, corrosive, and flammable liquids
- Circular cross-section
- May have external ring stiffeners
- MAWP of at least 25 psi

ROAD TRAILER IDENTIFICATION CHART

131 DOT406, TC406, SCT306/406, MC306, TC306

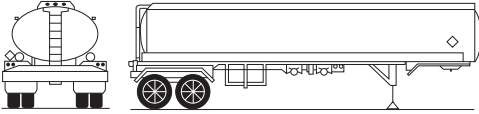

- For flammable liquids (e.g., gasoline, diesel)
- Elliptical cross-section
- Rollover protection at the top
- Bottom outlet valves
- MAWP between 3-5 psi (US + Mexico: MC306, DOT406, SCT306/406)
- MAWP between 3-15 psi (Canada: TC306/406)

137 DOT412, TC412, SCT312, MC312, TC312

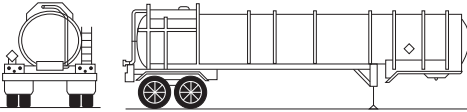

- Usually for corrosive liquids
- Circular cross-section
- External ring stiffeners
- Tank diameter is relatively small
- MAWP of at least 15 psi

112 TC423

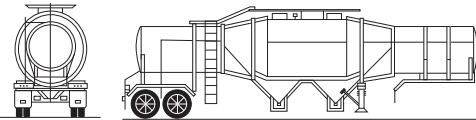

- For emulsion and water-gel explosives
- Hopper-style configuration
- MAWP between 5-15 psi

117 Compressed Gas/Tube Trailer

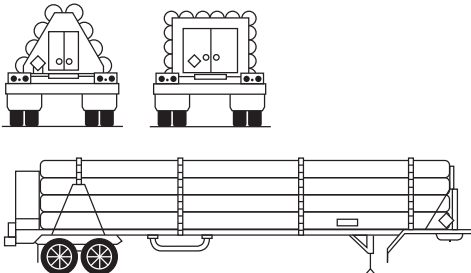

- For pressurized gases (e.g., air, helium, oxygen)
- Long horizontal tubes permanently mounted on a trailer
- Filling and discharge manifold typically located at the rear of trailer

ROAD TRAILER IDENTIFICATION CHART

134 Dry Bulk Cargo Trailer

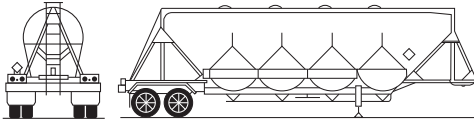

- For dry bulk cargo (e.g., oxidizers, corrosive solids, cement, plastic pellets, fertilizers)
- Also known as hopper tanks or hopper trailers
- Shape can vary but always contains one or more cone shaped bins

137 Vacuum Tanker

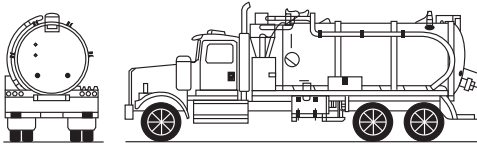

- For cleanup of chemical/oil spills or for hauling crude oil, water
- Large hinged rear door used for dumping

111 Mixed Cargo

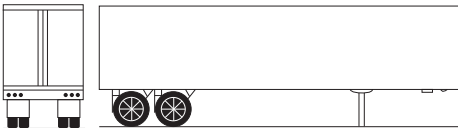

- For general freight that carry bulk or non-bulk packages
- May transport hazardous materials/ dangerous goods in small packages (e.g., bags, boxes, drums) or intermediate bulk containers (IBCs), sometimes referred to as "totes"
- Cargo door(s) in the rear

111 Intermodal Freight Container

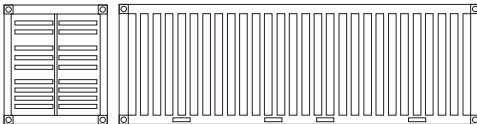

117 Intermodal Tank

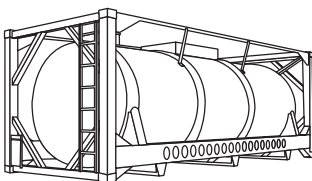

- For liquefied compressed gases, refrigerated liquefied gases, solids and liquids
- Working pressure may range from 20 to 500 psi
- Tank capacity can range from 50 to 12,000 gallons (200 to 45,000 L), and tank dimensions may vary

GLOBALLY HARMONIZED SYSTEM OF CLASSIFICATION AND LABELING OF CHEMICALS (GHS)

(May be found on means of containment during transport)

The Globally Harmonized System of Classification and Labeling of Chemicals (GHS) is an international guideline published by the United Nations. The GHS aims to harmonize the classification and labeling systems for all sectors involved in the life cycle of a chemical (production, storage, transport, workplace use, consumer use and presence in the environment).

The GHS has nine symbols used to convey specific physical, health and environmental hazard information. These symbols are part of a pictogram that is diamond shaped and includes the GHS symbol in black on a white background with a red frame. The pictogram is part of the GHS label, which also includes the following information:

- **Signal word**
- **Hazard statement**
- **Precautionary statements**
- **Product identifier**
- **Supplier identification**

GHS pictograms are similar in shape to transport labels; however, transport labels have backgrounds of different colors.

The elements of the GHS that address signal words and hazard statements are not expected to be adopted in the transport sector. For substances and mixtures covered by the UN Recommendations on the Transport of Dangerous Goods, Model Regulations, the transport labels for physical hazards will have precedence. In transport, a GHS pictogram for the same (or lesser) hazard as the one reflected by the transport label or placard should not be present, but it could exist on the package.

Examples of GHS labeling:

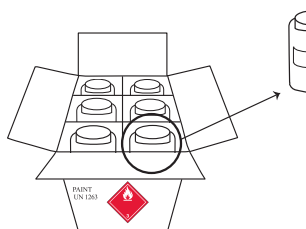

Outer Packaging: Box with flammable liquid transport label

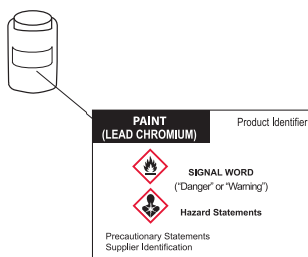



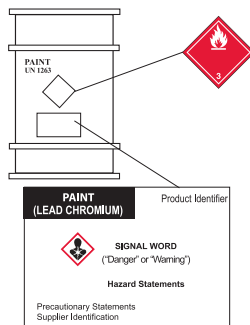







Inner Packaging: Plastic bottle with GHS hazard warning label



Single Packaging: 200 L (55 US gallons) drum with a flammable liquid transport label combined with GHS hazard warning label

In some cases, such as on drums or intermediate bulk containers (IBCs), which must address information for all sectors, the GHS label may be found in addition to the required transport labels and placards. Both types of labels (GHS and transport) will differ in a way that will make them easy to identify during an emergency.

GHS Pictograms	Physical hazards	GHS Pictograms	Health and Environmental hazards
	Explosive; Self-reactive; Organic peroxide		Skin corrosion; Serious eye damage
	Flammable; Pyrophoric; Self-reactive; Organic peroxide; Self-heating; Emits flammable gases when in contact with water		Acute toxicity (harmful); Skin sensitizer; Irritant (skin and eye); Narcotic effect; Respiratory tract irritant; Hazardous to ozone layer (environment)
	Oxidizer		Respiratory sensitizer; Mutagen; Carcinogen; Reproductive toxicity; Target organ toxicity; Aspiration hazard
	Gas under pressure		Hazardous to aquatic environment
	Corrosive to metals		Acute toxicity (fatal or toxic)

HAZARD IDENTIFICATION NUMBERS DISPLAYED ON SOME INTERMODAL CONTAINERS

Hazard identification numbers, utilized under European and some South American regulations, may be found in the top half of an orange panel on some intermodal bulk containers. The 4-digit ID number is in the bottom half of the orange panel.



The hazard identification number in the top half of the orange panel consists of two or three digits. In general, the digits indicate the following hazards:

- 2 - Emission of gas due to pressure or to chemical reaction
- 3 - Flammability of liquids (vapors) and gases or self-heating liquid
- 4 - Flammability of solids or self-heating solid
- 5 - Oxidizing (fire-intensifying) effect
- 6 - Toxicity or risk of infection
- 7 - Radioactivity
- 8 - Corrosivity
- 9 - Risk of spontaneous violent reaction

NOTE: The risk of spontaneous violent reaction within the meaning of digit 9 includes the possibility, due to the nature of a substance, of a risk of explosion, disintegration and polymerization reaction followed by the release of considerable heat or flammable and/or toxic gases.

- Doubling of a digit indicates an intensification of that particular hazard (e.g., 33, 66, 88).
- Where the hazard associated with a substance can be adequately indicated by a single digit, the digit is followed by a zero (e.g., 30, 40, 50).
- A hazard identification number prefixed by the letter "X" indicates that the substance will react dangerously with water (e.g., X88).
- For the transport of Class 1 materials, the hazard identification number will be replaced by the explosive's division number and compatibility group.

HAZARD IDENTIFICATION NUMBERS
DISPLAYED ON SOME INTERMODAL CONTAINERS

The hazard identification numbers listed below have the following meanings:

20	Asphyxiant gas or gas with no subsidiary hazard
22	Refrigerated liquefied gas, asphyxiant
223	Refrigerated liquefied gas, flammable
225	Refrigerated liquefied gas, oxidizing (fire-intensifying)
23	Flammable gas
238	Gas, flammable corrosive
239	Flammable gas which can spontaneously lead to violent reaction
25	Oxidizing (fire-intensifying) gas
26	Toxic gas
263	Toxic gas, flammable
265	Toxic gas, oxidizing (fire-intensifying)
268	Toxic gas, corrosive
28	Gas, corrosive
<hr/>	
30	Flammable liquid (flash-point between 23°C and 60°C, inclusive), or flammable liquid or solid in the molten state with a flash-point above 60°C, heated to a temperature equal to or above its flash-point, or self-heating liquid
323	Flammable liquid which reacts with water, emitting flammable gases
X323	Flammable liquid which reacts dangerously with water, emitting flammable gases
33	Highly flammable liquid (flash-point below 23°C)
333	Pyrophoric liquid
X333	Pyrophoric liquid which reacts dangerously with water
336	Highly flammable liquid, toxic
338	Highly flammable liquid, corrosive
X338	Highly flammable liquid, corrosive, which reacts dangerously with water
339	Highly flammable liquid which can spontaneously lead to violent reaction
36	Flammable liquid (flash-point between 23°C and 60°C, inclusive), slightly toxic, or self-heating liquid, toxic
362	Flammable liquid, toxic, which reacts with water, emitting flammable gases
X362	Flammable liquid, toxic, which reacts dangerously with water, emitting flammable gases
368	Flammable liquid, toxic, corrosive
38	Flammable liquid (flash-point between 23°C and 60°C, inclusive), slightly corrosive or self-heating liquid, corrosive
382	Flammable liquid, corrosive, which reacts with water, emitting flammable gases
X382	Flammable liquid, corrosive, which reacts dangerously with water, emitting flammable gases
39	Flammable liquid, which can spontaneously lead to violent reaction
<hr/>	
40	Flammable solid, or self-reactive substance, or self-heating substance, or polymerizing substance

HAZARD IDENTIFICATION NUMBERS
DISPLAYED ON SOME INTERMODAL CONTAINERS

423	Solid which reacts with water, emitting flammable gases, or flammable solid which reacts with water, emitting flammable gases, or self-heating solid which reacts with water, emitting flammable gases
X423	Solid which reacts dangerously with water, emitting flammable gases, or flammable solid which reacts dangerously with water, emitting flammable gases, or self-heating solid which reacts dangerously with water, emitting flammable gases
43	Spontaneously flammable (pyrophoric) solid
X432	Spontaneously flammable (pyrophoric) solid which reacts dangerously with water, emitting flammable gases
44	Flammable solid, in the molten state at an elevated temperature
446	Flammable solid, toxic, in the molten state at an elevated temperature
46	Flammable or self-heating solid, toxic
462	Toxic solid which reacts with water, emitting flammable gases
X462	Solid which reacts dangerously with water, emitting toxic gases
48	Flammable or self-heating solid, corrosive
482	Corrosive solid which reacts with water, emitting flammable gases
X482	Solid which reacts dangerously with water, emitting corrosive gases
<hr/>	
50	Oxidizing (fire-intensifying) substance
539	Flammable organic peroxide
55	Strongly oxidizing (fire-intensifying) substance
556	Strongly oxidizing (fire-intensifying) substance, toxic
558	Strongly oxidizing (fire-intensifying) substance, corrosive
559	Strongly oxidizing (fire-intensifying) substance which can spontaneously lead to violent reaction
56	Oxidizing substance (fire-intensifying), toxic
568	Oxidizing substance (fire-intensifying), toxic, corrosive
58	Oxidizing substance (fire-intensifying), corrosive
59	Oxidizing substance (fire-intensifying) which can spontaneously lead to violent reaction
<hr/>	
60	Toxic or slightly toxic substance
606	Infectious substance
623	Toxic liquid, which reacts with water, emitting flammable gases
63	Toxic substance, flammable (flash-point between 23°C and 60°C, inclusive)
638	Toxic substance, flammable (flash-point between 23°C and 60°C, inclusive), corrosive
639	Toxic substance, flammable (flash-point not above 60°C) which can spontaneously lead to violent reaction
64	Toxic solid, flammable or self-heating
642	Toxic solid which reacts with water, emitting flammable gases
65	Toxic substance, oxidizing (fire-intensifying)
66	Highly toxic substance
663	Highly toxic substance, flammable (flash-point not above 60°C)

HAZARD IDENTIFICATION NUMBERS
DISPLAYED ON SOME INTERMODAL CONTAINERS

664	Highly toxic solid, flammable or self-heating
665	Highly toxic substance, oxidizing (fire-intensifying)
668	Highly toxic substance, corrosive
X668	Highly toxic substance, corrosive, which reacts dangerously with water
669	Highly toxic substance which can spontaneously lead to violent reaction
68	Toxic substance, corrosive
69	Toxic or slightly toxic substance which can spontaneously lead to violent reaction
<hr/>	
70	Radioactive material
768	Radioactive material, toxic, corrosive
78	Radioactive material, corrosive
<hr/>	
80	Corrosive or slightly corrosive substance
X80	Corrosive or slightly corrosive substance which reacts dangerously with water
823	Corrosive liquid which reacts with water, emitting flammable gases
83	Corrosive or slightly corrosive substance, flammable (flash-point between 23°C and 60°C, inclusive)
X83	Corrosive or slightly corrosive substance, flammable (flash-point between 23°C and 60°C, inclusive), which reacts dangerously with water
836	Corrosive or slightly corrosive substance, flammable (flash-point between 23°C and 60°C, inclusive) and toxic
839	Corrosive or slightly corrosive substance, flammable (flash-point between 23°C and 60°C, inclusive), which can spontaneously lead to violent reaction
X839	Corrosive or slightly corrosive substance, flammable (flash-point between 23°C and 60°C, inclusive), which can spontaneously lead to violent reaction and which reacts dangerously with water
84	Corrosive solid, flammable or self-heating
842	Corrosive solid which reacts with water, emitting flammable gases
85	Corrosive or slightly corrosive substance, oxidizing (fire-intensifying)
856	Corrosive or slightly corrosive substance, oxidizing (fire-intensifying) and toxic
86	Corrosive or slightly corrosive substance, toxic
88	Highly corrosive substance
X88	Highly corrosive substance which reacts dangerously with water
883	Highly corrosive substance, flammable (flash-point between 23°C and 60°C, inclusive)
884	Highly corrosive solid, flammable or self-heating
885	Highly corrosive substance, oxidizing (fire-intensifying)
886	Highly corrosive substance, toxic
X886	Highly corrosive substance, toxic, which reacts dangerously with water
89	Corrosive or slightly corrosive substance which can spontaneously lead to violent reaction
<hr/>	
90	Environmentally hazardous substance; miscellaneous dangerous substances
99	Miscellaneous dangerous substance carried at an elevated temperature

PIPELINE TRANSPORTATION

In North America, hazardous materials/dangerous goods are commonly transported through millions of miles of pipelines and related structures. Products transported include natural gas, natural gas liquids, crude oil, gasoline, diesel fuel, anhydrous ammonia, carbon dioxide, jet fuel, and other commodities. Although most pipelines are buried, often there are above-ground structures and markers indicating the presence of pipelines. First responders should be aware of the pipelines in their jurisdictions, the products they transport, and the operators responsible for those pipelines. Proactive relationships can be beneficial in the safe and effective management of pipeline emergencies.

Types of Pipelines

Natural Gas Pipelines

Natural Gas Transmission Pipelines

Large-diameter, steel pipelines transport flammable natural gas (toxic and non-toxic) at very high pressures ranging from 200 to 1,500 psi*. Natural gas in transmission pipelines is odorless—generally **not odorized** with mercaptan (the “rotten egg” smell); however, natural gas containing hydrogen sulfide (H₂S) will have a distinct “rotten egg” odor.

Natural Gas Distribution Pipelines

Natural gas is delivered directly to customers via distribution pipelines. These pipelines are typically smaller-diameter, lower-pressure pipelines constructed of steel, plastic, or cast iron. Natural gas in distribution pipelines **is odorized** with mercaptan (the “rotten egg” smell).

Natural Gas-Gathering and Natural Gas Well Production Pipelines

Natural gas-gathering/well production pipelines collect “raw” natural gas from wellheads and transport the product to gas-processing and/or gas-treating plants. These gathering pipelines carry natural gas mixed with some quantity of natural gas liquids, water, and, in some areas, contaminants such as toxic hydrogen sulfide (H₂S). Natural gas in these pipelines is **not odorized** with mercaptan (the “rotten egg” smell); however, natural gas that contains hydrogen sulfide (H₂S) will have a distinct “rotten egg” odor.

Hazardous Liquid and Highly Volatile Liquid Pipelines

Hazardous Liquid Pipelines

Crude oil, refined petroleum products (e.g. gasoline, kerosene, jet fuel or diesel) and hazardous liquids (e.g. anhydrous ammonia or ethanol) are often transported by pipelines.

Many liquid petroleum pipelines transport different types of liquid petroleum in the same pipeline. To do so, the pipeline operator sends different products in “batches.” For example, an operator could send gasoline for several hours, and then switch to jet fuels, before switching to diesel fuel.

* Data from <http://naturalgas.org/naturalgas/transport/>

Highly Volatile Liquid (HVL) Pipelines

HVL pipelines transport hazardous liquids which will form a vapor cloud when released to the atmosphere and which have a vapor pressure exceeding 276 KPa (40 psia) at 37.8°C (100°F). An example of an HVL is liquid propane.

Pipeline Markers

Since pipelines are usually buried underground, pipeline markers are used to indicate their presence in an area along the pipeline route. Of the three types of pipelines typically buried underground — distribution, gathering, and transmission — only transmission pipelines are marked with the following above-ground markers used to indicate their route.



Markers warn that a transmission pipeline is located in the area, identify the product transported in the line, and provide the name and telephone number of the pipeline operator to call. Markers and warning signs are located at frequent intervals along natural gas and liquid transmission pipeline rights-of-way, and are located at prominent points such as where pipelines intersect streets, highways, railways, or waterways.

Pipeline markers only indicate the presence of a pipeline—they do not indicate the exact location of the pipeline. Pipeline locations within a right-of-way may vary along its length and there may be multiple pipelines located in the same right-of-way.

NOTE:

- Markers for pipelines transporting materials containing dangerous levels of hydrogen sulfide (H₂S) may have markers that say: “Sour” or “Poison.”
- Natural gas distribution pipelines are not marked with above-ground signs.
- Gathering/production pipelines are often not marked with above-ground signs.

Pipeline Structures (Above Ground)

Natural Gas Transmission Pipelines:	Compressor stations, valves, metering stations.
Natural Gas Distribution Pipelines:	Regulator stations, customer meters and regulators, valve box covers.
Natural Gas Gathering/Well Production Pipelines:	Compressor stations, valves, metering stations, wellheads, piping, manifolds.
Petroleum and Hazardous Liquids Pipelines:	Storage tanks, valves, pump stations, loading racks.

Indications of Pipeline Leaks and Ruptures

Pipeline releases can range from relatively minor leaks to catastrophic ruptures. It is important to remember that gases and liquids behave differently once they are released from a pipeline. Generally, the following could be indications of a pipeline leak or rupture:

- Hissing, roaring, or explosive sound
- Flames appearing from the ground or water (perhaps very large flames)
- Vapor cloud/fog/mist
- Dirt/debris/water blowing out of the ground
- Liquids bubbling up from the ground or bubbling in water
- Distinctive, unusually strong odor of rotten eggs, mercaptan (an odorant in some natural gas pipelines), skunk, or petroleum
- Discolored/dead vegetation or discolored snow above a pipeline right-of-way
- Oil slick or sheen on flowing/standing water
- An area of frozen ground in the summer
- An unusual area of melted snow in the winter

General Considerations for Responding to a Pipeline Emergency

- **Safety First!** Your safety and the safety of the community you protect is top priority. Remember to approach a pipeline incident from upwind, uphill, and upstream while using air monitoring equipment to detect for the presence of explosive and/or toxic levels of hazardous materials/dangerous goods.
 - Always wear proper personal protective equipment. Be prepared for a flash fire. Use shielding to protect first responders in the event of an explosion. Use respiratory protection.
 - Never operate pipeline valves (except in coordination with the pipeline operator); this could make the incident worse and put you and others in danger.
 - Never attempt to extinguish a pipeline fire before supply is shut off; this could result in the accumulation of a large flammable/explosive vapor cloud or liquid pool that could make the incident worse and put you and others in danger.
 - Do not walk or drive into a vapor cloud in an attempt to identify the product(s) involved.
 - Do not park over manholes or storm drains.
 - Do not approach the scene with vehicles or mechanical equipment until the isolation zones have been established (vehicles are a potential ignition source).
- **Secure the site** and determine a plan to evacuate or shelter-in-place. Work with other responders to deny entry to an area.
- **Identify the product and the operator.** If safe to do so, you may be able to identify the product based on its characteristics or other external clues. Look for pipeline markers indicating the product, operator of the pipeline, and their emergency contact information. Pipelines transport many different types of products, including gases, liquids, and highly volatile liquids that are in a liquid state inside the pipeline but in a gaseous state if released from the pipeline. The vapor density of gases determines if they rise or sink in air. Viscosity and specific gravity also are important characteristics of hazardous liquids to consider. Identification of the product also will help you determine the appropriate distance for isolation of the affected area.
- **Notify the pipeline operator** using the emergency contact information on the pipeline marker or other contact information you may have received from the pipeline operator. The pipeline operator will be a resource to you in the response.
- **Establish a command post.** Implement the Incident Command Structure, as needed, and be prepared to implement a Unified Command as additional stakeholders and resources arrive.

Other Important Considerations

- If no flames are present, do not introduce ignition sources such as open flames, running vehicles, or electrical equipment (cell phones, pagers, two-way radios, lights, garage door openers, fans, door bells, etc.).
- Abandon any equipment used in or near the area of the pipeline release.
- If there is no risk to your safety or the safety of others, move far enough away from any noise coming from the pipeline to allow for normal conversation.
- Pipelines often are close to other public utilities, railroads, and highways; these can be impacted by pipeline releases or may be potential ignition sources.
- Natural gas can migrate underground from the source of a release to other areas via the path of least resistance (including through sewers, water lines, and geologic formations).

Considerations for Establishing Protective Action Distances

- Type of product
 - If you know the material involved, identify the three-digit guide number by looking up the name in the alphabetical list (blue section). The relevant guide will provide an idea of the risks posed by the material.
- Pressure and diameter of pipe (the pipeline operator can tell you this if you don't already know it)
- Timing of valve closure by the pipeline operator (quickly for automated valves; longer for manually operated valves)
- Dissipation time of the product in the pipeline once valves are closed
- Ability to conduct atmospheric monitoring and/or air sampling
- Weather (wind direction, etc.)
- Local variables such as topography, population density, demographics, and fire suppression methods available
- Nearby building construction material/density
- Natural and man-made barriers (such as highways, railroads, rivers, etc.)

U.S. Pipeline Resources

U.S. Pipeline Locations: The National Pipeline Mapping System (NPMS) <https://www.npms.phmsa.dot.gov> indicates the general locations of hazardous liquids and natural gas transmission pipelines found within the U.S. The pipelines depicted in the NPMS are within 500 feet of their actual locations. Emergency responders may apply for an NPMS web viewer account that will allow access to more detailed information than is available to the general public. The NPMS does not contain gathering/production or natural gas distribution pipelines.

U.S. Pipeline Emergency Response Training: Where appropriate, reference pipeline emergencies training materials produced by the Pipeline and Hazardous Materials Safety Administration. Your state or jurisdiction also may provide training on how to handle the response to a pipeline incident.

Other Resources:

Pipeline Association for Public Awareness

<https://www.pipelineawareness.org/>

U.S. DOT, Pipeline and Hazardous Materials Safety Administration

<https://www.phmsa.dot.gov/safety-awareness/pipeline/safety-awareness-overview>

Pipeline Emergency Responders Initiative (PERI)

<https://www.phmsa.dot.gov/pipeline/peri/pipeline-emergency-responders-initiative-peri>

Canadian Pipeline Resources

For more information about pipelines in Canada, please consult the Canada Energy Regulator website:

<https://www.cer-rec.gc.ca/en/index.html>

INTRODUCTION TO YELLOW SECTION

For entries highlighted in green follow these steps:

- **IF THERE IS NO FIRE:**

- Go directly to **Table 1** (green section)
- Look up the ID number and name of material
- Identify initial isolation and protective action distances
- Also consult the appropriate Orange Guide

- **IF A FIRE IS INVOLVED:**

- Use the appropriate Orange Guide for **EVACUATION** distances
- Also protect in downwind direction according to Table 1 for residual material release

Note 1: If the name in **Table 1** is shown with **(when spilled in water)**, these materials produce large amounts of Toxic Inhalation Hazard (TIH) (PIH in the US) gases when spilled in water. Some water-reactive materials are also TIH materials themselves (e.g., UN1746 (Bromine trifluoride), UN1836 (Thionyl chloride)). In these instances, two entries are provided in **Table 1** for land-based and water-based spills. If a water-reactive material only has one entry in Table 1 for **(when spilled in water)** and the product is NOT spilled in water, Table 1 and Table 2 do not apply. You will find safe distances in the appropriate Orange Guide.

Note 2: Explosives are not individually listed by their ID number because in an emergency situation, the response will be based only on the division of the explosive, not on the individual explosive.

For divisions 1.1, 1.2, 1.3 and 1.5, refer to GUIDE 112.

For divisions 1.4 and 1.6, refer to GUIDE 114.

Note 3: Chemical and biological warfare agents are now found in the "Criminal or Terrorist Use of Chemical, Biological and Radiological Agents" section.

ID No.	Guide No.	Name of Material
— —	112	Ammonium nitrate-fuel oil mixtures
— —	112	Blasting agent, n.o.s.
— —	112	Explosives, division 1.1, 1.2, 1.3 or 1.5
— —	114	Explosives, division 1.4 or 1.6
1001	116	Acetylene, dissolved
1002	122	Air, compressed
1003	122	Air, refrigerated liquid (cryogenic liquid)
1005	125	Ammonia, anhydrous
1005	125	Anhydrous ammonia
1006	120	Argon
1006	120	Argon, compressed
1008	125	Boron trifluoride
1008	125	Boron trifluoride, compressed
1009	126	Bromotrifluoromethane
1009	126	Refrigerant gas R-13B1
1010	116P	Butadienes, stabilized
1010	116P	Butadienes and hydrocarbon mixture, stabilized
1011	115	Butane
1012	115	Butylene
1013	120	Carbon dioxide
1013	120	Carbon dioxide, compressed
1016	119	Carbon monoxide, compressed
1017	124	Chlorine
1018	126	Chlorodifluoromethane
1018	126	Refrigerant gas R-22
1020	126	Chloropentafluoroethane
1020	126	Refrigerant gas R-115
1021	126	1-Chloro-1,2,2,2-tetrafluoroethane
1021	126	Refrigerant gas R-124

ID No.	Guide No.	Name of Material
1022	126	Chlorotrifluoromethane
1022	126	Refrigerant gas R-13
1023	119	Coal gas, compressed
1026	119	Cyanogen
1027	115	Cyclopropane
1028	126	Dichlorodifluoromethane
1028	126	Refrigerant gas R-12
1029	126	Dichlorofluoromethane
1029	126	Refrigerant gas R-21
1030	115	1,1-Difluoroethane
1030	115	Refrigerant gas R-152a
1032	118	Dimethylamine, anhydrous
1033	115	Dimethyl ether
1035	115	Ethane
1035	115	Ethane, compressed
1036	118	Ethylamine
1037	115	Ethyl chloride
1038	115	Ethylene, refrigerated liquid (cryogenic liquid)
1039	115	Ethyl methyl ether
1039	115	Methyl ethyl ether
1040	119P	Ethylene oxide
1040	119P	Ethylene oxide with nitrogen
1041	115	Ethylene oxide and carbon dioxide mixture, with more than 9% but not more than 87% ethylene oxide
1043	125	Fertilizer, ammoniating solution, with free ammonia
1044	126	Fire extinguishers with compressed or liquefied gas
1045	124	Fluorine, compressed
1046	120	Helium, compressed
1048	125	Hydrogen bromide, anhydrous

ID No.	Guide No.	Name of Material
1049	115	Hydrogen, compressed
1050	125	Hydrogen chloride, anhydrous
1051	117P	Hydrogen cyanide, stabilized
1052	125	Hydrogen fluoride, anhydrous
1053	117	Hydrogen sulfide
1053	117	Hydrogen sulphide
1055	115	Isobutylene
1056	120	Krypton, compressed
1057	115	Lighter refills containing flammable gas
1057	115	Lighters containing flammable gas
1057	128	Lighters, non-pressurized, containing flammable liquid
1058	120	Liquefied gases, non-flammable, charged with nitrogen, carbon dioxide or air
1060	116P	Methylacetylene and propadiene mixture, stabilized
1061	118	Methylamine, anhydrous
1062	123	Methyl bromide
1063	115	Methyl chloride
1063	115	Refrigerant gas R-40
1064	117	Methyl mercaptan
1065	120	Neon, compressed
1066	120	Nitrogen, compressed
1067	124	Dinitrogen tetroxide
1067	124	Nitrogen dioxide
1069	125	Nitrosyl chloride
1070	122	Nitrous oxide
1070	122	Nitrous oxide, compressed
1071	119	Oil gas, compressed
1072	122	Oxygen, compressed
1073	122	Oxygen, refrigerated liquid (cryogenic liquid)

ID No.	Guide No.	Name of Material
1075	115	Butane
1075	115	Butylene
1075	115	Isobutane
1075	115	Isobutylene
1075	115	Liquefied petroleum gas
1075	115	LPG
1075	115	Petroleum gases, liquefied
1075	115	Propane
1075	115	Propylene
1076	125	Phosgene
1077	115	Propylene
1078	126	Refrigerant gas, n.o.s.
1079	125	Sulfur dioxide
1079	125	Sulphur dioxide
1080	126	Sulfur hexafluoride
1080	126	Sulphur hexafluoride
1081	116P	Tetrafluoroethylene, stabilized
1082	119P	Refrigerant gas R-1113
1082	119P	Trifluorochloroethylene, stabilized
1083	118	Trimethylamine, anhydrous
1085	116P	Vinyl bromide, stabilized
1086	116P	Vinyl chloride, stabilized
1087	116P	Vinyl methyl ether, stabilized
1088	127	Acetal
1089	129P	Acetaldehyde
1090	127	Acetone
1091	127	Acetone oils
1092	131P	Acrolein, stabilized
1093	131P	Acrylonitrile, stabilized
1098	131	Allyl alcohol
1099	131P	Allyl bromide

ID Guide Name of Material
No. No.

1100 **131P** Allyl chloride
1104 **129** Amyl acetates
1105 **129** Pentanols
1106 **132** Amylamine
1107 **129** Amyl chloride
1108 **128** n-Amylene
1108 **128** 1-Pentene
1109 **129** Amyl formates
1110 **127** n-Amyl methyl ketone
1110 **127** Methyl amyl ketone
1111 **130** Amyl mercaptan
1112 **128** Amyl nitrate
1113 **129** Amyl nitrite
1114 **130** Benzene
1120 **129** Butanols
1123 **129** Butyl acetates
1125 **132** n-Butylamine
1126 **130** 1-Bromobutane
1126 **130** n-Butyl bromide
1127 **130** n-Butyl chloride
1127 **130** Chlorobutanes
1128 **129** n-Butyl formate
1129 **129P** Butyraldehyde
1130 **128** Camphor oil
1131 **131** Carbon bisulfide
1131 **131** Carbon disulfide
1131 **131** Carbon disulphide
1133 **128** Adhesives (flammable)
1134 **130** Chlorobenzene
1135 131 Ethylene chlorohydrin
1136 **128** Coal tar distillates, flammable
1139 **127** Coating solution

ID Guide Name of Material
No. No.

1143 131P Crotonaldehyde
1143 131P Crotonaldehyde, stabilized
1144 **128** Crotonylene
1145 **128** Cyclohexane
1146 **128** Cyclopentane
1147 **130** Decahydronaphthalene
1148 **129** Diacetone alcohol
1149 **128** Butyl ethers
1149 **128** Dibutyl ethers
1150 **130P** 1,2-Dichloroethylene
1152 **130** Dichloropentanes
1153 **127** Ethylene glycol diethyl ether
1154 **132** Diethylamine
1155 **127** Diethyl ether
1155 **127** Ethyl ether
1156 **127** Diethyl ketone
1157 **128** Diisobutyl ketone
1158 **132** Diisopropylamine
1159 **127** Diisopropyl ether
1160 **132** Dimethylamine, aqueous solution
1160 **132** Dimethylamine, solution
1161 **129** Dimethyl carbonate
1162 155 Dimethyldichlorosilane
1163 131 Dimethylhydrazine, unsymmetrical
1164 **130** Dimethyl sulfide
1164 **130** Dimethyl sulphide
1165 **127** Dioxane
1166 **127** Dioxolane
1167 **128P** Divinyl ether, stabilized
1169 **127** Extracts, aromatic, liquid
1170 **127** Ethanol

ID Guide
No. No.

Name of Material

ID Guide
No. No.

Name of Material

1170 **127** Ethanol, solution
1170 **127** Ethyl alcohol
1170 **127** Ethyl alcohol, solution
1171 **127** Ethylene glycol monoethyl ether
1172 **129** Ethylene glycol monoethyl ether acetate
1173 **129** Ethyl acetate
1175 **130** Ethylbenzene
1176 **129** Ethyl borate
1177 **130** 2-Ethylbutyl acetate
1178 **130** 2-Ethylbutyraldehyde
1179 **127** Ethyl butyl ether
1180 **130** Ethyl butyrate
1181 **155** Ethyl chloroacetate
1182 **155** Ethyl chloroformate
1183 **139** Ethyldichlorosilane
1184 **131** Ethylene dichloride
1185 **131P** Ethyleneimine, stabilized
1188 **127** Ethylene glycol monomethyl ether
1189 **129** Ethylene glycol monomethyl ether acetate
1190 **129** Ethyl formate
1191 **129** Ethylhexaldehyde
1191 **129** Octyl aldehydes
1192 **129** Ethyl lactate
1193 **127** Ethyl methyl ketone
1193 **127** Methyl ethyl ketone
1194 **131** Ethyl nitrite, solution
1195 **129** Ethyl propionate
1196 **155** Ethyltrichlorosilane
1197 **127** Extracts, flavoring, liquid
1197 **127** Extracts, flavouring, liquid

1197 **127** Extracts, liquid
1198 **132** Formaldehyde, solution, flammable
1198 **132** Formalin (flammable)
1199 **153P** Furaldehydes
1201 **127** Fusel oil
1202 **128** Diesel fuel
1202 **128** Gas oil
1202 **128** Heating oil, light
1203 **128** Gasoline
1203 **128** Motor spirit
1203 **128** Petrol
1204 **127** Nitroglycerin, solution in alcohol, with not more than 1% nitroglycerin
1206 **128** Heptanes
1207 **130** Hexaldehyde
1208 **128** Hexanes
1208 **128** Neohexane
1210 **129** Printing ink, flammable
1210 **129** Printing ink related material, flammable
1212 **129** Isobutanol
1212 **129** Isobutyl alcohol
1213 **129** Isobutyl acetate
1214 **132** Isobutylamine
1216 **128** Isooctenes
1218 **130P** Isoprene, stabilized
1219 **129** Isopropanol
1219 **129** Isopropyl alcohol
1220 **129** Isopropyl acetate
1221 **132** Isopropylamine
1222 **130** Isopropyl nitrate
1223 **128** Kerosene

ID Guide
No. No.

Name of Material

1224 **127** Ketones, liquid, n.o.s.
1228 **131** Mercaptan mixture, liquid,
flammable, poisonous, n.o.s.
1228 **131** Mercaptan mixture, liquid,
flammable, toxic, n.o.s.
1228 **131** Mercaptans, liquid, flammable,
poisonous, n.o.s.
1228 **131** Mercaptans, liquid, flammable,
toxic, n.o.s.
1229 **129** Mesityl oxide
1230 **131** Methanol
1230 **131** Methyl alcohol
1231 **129** Methyl acetate
1233 **130** Methylamyl acetate
1234 **127** Methylal
1235 **132** Methylamine, aqueous solution
1237 **129** Methyl butyrate
1238 **155** Methyl chloroformate
1239 **131** Methyl chloromethyl ether
1242 **139** Methyl dichlorosilane
1243 **129** Methyl formate
1244 **131** Methylhydrazine
1245 **127** Methyl isobutyl ketone
1246 **127P** Methyl isopropenyl ketone,
stabilized
1247 **129P** Methyl methacrylate monomer,
stabilized
1248 **129** Methyl propionate
1249 **127** Methyl propyl ketone
1250 **155** Methyltrichlorosilane
1251 **131P** Methyl vinyl ketone, stabilized
1259 **131** Nickel carbonyl
1261 **129** Nitromethane
1262 **128** Isooctane

ID Guide
No. No.

Name of Material

1262 **128** Octanes
1263 **128** Paint (flammable)
1263 **128** Paint related material
(flammable)
1264 **129** Paraldehyde
1265 **128** Isopentane
1265 **128** Pentanes
1266 **127** Perfumery products, with
flammable solvents
1267 **128** Petroleum crude oil
1268 **128** Petroleum distillates, n.o.s.
1268 **128** Petroleum products, n.o.s.
1270 **128** Petroleum oil
1272 **129** Pine oil
1274 **129** n-Propanol
1274 **129** Propyl alcohol, normal
1275 **129P** Propionaldehyde
1276 **129** n-Propyl acetate
1277 **132** Propylamine
1278 **129** 1-Chloropropane
1278 **129** Propyl chloride
1279 **130** 1,2-Dichloropropane
1280 **127P** Propylene oxide
1281 **129** Propyl formates
1282 **129** Pyridine
1286 **127** Rosin oil
1287 **127** Rubber solution
1288 **128** Shale oil
1289 **132** Sodium methylate, solution in
alcohol
1292 **129** Ethyl silicate
1292 **129** Tetraethyl silicate
1293 **127** Tinctures, medicinal

ID No.	Guide No.	Name of Material
1294	130	Toluene
1295	139	Trichlorosilane
1296	132	Triethylamine
1297	132	Trimethylamine, aqueous solution
1298	155	Trimethylchlorosilane
1299	128	Turpentine
1300	128	Turpentine substitute
1301	129P	Vinyl acetate, stabilized
1302	127P	Vinyl ethyl ether, stabilized
1303	130P	Vinylidene chloride, stabilized
1304	127P	Vinyl isobutyl ether, stabilized
1305	155P	Vinyltrichlorosilane
1306	129	Wood preservatives, liquid
1307	130	Xylenes
1308	170	Zirconium suspended in a flammable liquid
1308	170	Zirconium suspended in a liquid (flammable)
1309	170	Aluminum powder, coated
1310	113	Ammonium picrate, wetted with not less than 10% water
1312	133	Borneol
1313	133	Calcium resinate
1314	133	Calcium resinate, fused
1318	133	Cobalt resinate, precipitated
1320	113	Dinitrophenol, wetted with not less than 15% water
1321	113	Dinitrophenolates, wetted with not less than 15% water
1322	113	Dinitroresorcinol, wetted with not less than 15% water
1323	170	Ferrocium
1324	133	Films, nitrocellulose base
1325	133	Flammable solid, organic, n.o.s.

ID No.	Guide No.	Name of Material
1325	133	Fusee (railway or highway)
1326	170	Hafnium powder, wetted with not less than 25% water
1327	133	Bhusa, wet, damp or contaminated with oil
1327	133	Hay, wet, damp or contaminated with oil
1327	133	Straw, wet, damp or contaminated with oil
1328	133	Hexamethylenetetramine
1330	133	Manganese resinate
1331	133	Matches, "strike anywhere"
1332	133	Metaldehyde
1333	170	Cerium, slabs, ingots or rods
1334	133	Naphthalene, crude
1334	133	Naphthalene, refined
1336	113	Nitroguanidine, wetted with not less than 20% water
1336	113	Picrite, wetted with not less than 20% water
1337	113	Nitrostarch, wetted with not less than 20% water
1338	133	Phosphorus, amorphous
1338	133	Red phosphorus
1339	139	Phosphorus heptasulfide, free from yellow and white phosphorus
1339	139	Phosphorus heptasulphide, free from yellow and white phosphorus
1340	139	Phosphorus pentasulfide, free from yellow and white phosphorus
1340	139	Phosphorus pentasulphide, free from yellow and white phosphorus
1341	139	Phosphorus sesquisulfide, free from yellow and white phosphorus

ID No.	Guide No.	Name of Material
1341	139	Phosphorus sesquisulphide, free from yellow and white phosphorus
1343	139	Phosphorus trisulfide, free from yellow and white phosphorus
1343	139	Phosphorus trisulphide, free from yellow and white phosphorus
1344	113	Picric acid, wetted with not less than 30% water
1344	113	Trinitrophenol, wetted with not less than 30% water
1345	133	Rubber scrap, powdered or granulated
1345	133	Rubber shoddy, powdered or granulated
1346	170	Silicon powder, amorphous
1347	113	Silver picrate, wetted with not less than 30% water
1348	113	Sodium dinitro-o-cresolate, wetted with not less than 15% water
1349	113	Sodium picramate, wetted with not less than 20% water
1350	133	Sulfur
1350	133	Sulphur
1352	170	Titanium powder, wetted with not less than 25% water
1353	133	Fabrics impregnated with weakly nitrated nitrocellulose, n.o.s.
1353	133	Fibers impregnated with weakly nitrated nitrocellulose, n.o.s.
1353	133	Fibres impregnated with weakly nitrated nitrocellulose, n.o.s.
1354	113	Trinitrobenzene, wetted with not less than 30% water
1355	113	Trinitrobenzoic acid, wetted with not less than 30% water

ID No.	Guide No.	Name of Material
1356	113	TNT, wetted with not less than 30% water
1356	113	Trinitrotoluene, wetted with not less than 30% water
1357	113	Urea nitrate, wetted with not less than 20% water
1358	170	Zirconium powder, wetted with not less than 25% water
1360	139	Calcium phosphide
1361	133	Carbon, animal or vegetable origin
1361	133	Charcoal
1362	133	Carbon, activated
1363	135	Copra
1364	133	Cotton waste, oily
1365	133	Cotton
1365	133	Cotton, wet
1369	135	p-Nitrosodimethylaniline
1372	133	Fibers, animal or vegetable, burnt, wet or damp
1372	133	Fibres, animal or vegetable, burnt, wet or damp
1373	133	Fabrics, animal or vegetable or synthetic, n.o.s. with oil
1373	133	Fibers, animal or vegetable or synthetic, n.o.s. with oil
1373	133	Fibres, animal or vegetable or synthetic, n.o.s. with oil
1374	133	Fish meal, unstabilized
1374	133	Fish scrap, unstabilized
1376	135	Iron oxide, spent
1376	135	Iron sponge, spent
1378	170	Metal catalyst, wetted
1379	133	Paper, unsaturated oil treated
1380	135	Pentaborane

ID No.	Guide No.	Name of Material
1381	136	Phosphorus, white, dry or under water or in solution
1381	136	Phosphorus, yellow, dry or under water or in solution
1381	136	White phosphorus, dry or under water or in solution
1381	136	Yellow phosphorus, dry or under water or in solution
1382	135	Potassium sulfide, anhydrous
1382	135	Potassium sulfide, with less than 30% water of crystallization
1382	135	Potassium sulphide, anhydrous
1382	135	Potassium sulphide, with less than 30% water of crystallization
1383	135	Aluminum powder, pyrophoric
1383	135	Pyrophoric alloy, n.o.s.
1383	135	Pyrophoric metal, n.o.s.
1384	135	Sodium dithionite
1384	135	Sodium hydrosulfite
1384	135	Sodium hydrosulphite
1385	135	Sodium sulfide, anhydrous
1385	135	Sodium sulfide, with less than 30% water of crystallization
1385	135	Sodium sulphide, anhydrous
1385	135	Sodium sulphide, with less than 30% water of crystallization
1386	135	Seed cake, with more than 1.5% oil and not more than 11% moisture
1387	133	Wool waste, wet
1389	138	Alkali metal amalgam, liquid
1390	139	Alkali metal amides
1391	138	Alkali metal dispersion
1391	138	Alkaline earth metal dispersion

ID No.	Guide No.	Name of Material
1392	138	Alkaline earth metal amalgam, liquid
1393	138	Alkaline earth metal alloy, n.o.s.
1394	138	Aluminum carbide
1395	139	Aluminum ferrosilicon powder
1396	138	Aluminum powder, uncoated
1397	139	Aluminum phosphide
1398	138	Aluminum silicon powder, uncoated
1400	138	Barium
1401	138	Calcium
1402	138	Calcium carbide
1403	138	Calcium cyanamide, with more than 0.1% calcium carbide
1404	138	Calcium hydride
1405	138	Calcium silicide
1407	138	Caesium
1407	138	Cesium
1408	139	Ferrosilicon
1409	138	Metal hydrides, water-reactive, n.o.s.
1410	138	Lithium aluminum hydride
1411	138	Lithium aluminum hydride, ethereal
1413	138	Lithium borohydride
1414	138	Lithium hydride
1415	138	Lithium
1417	138	Lithium silicon
1418	138	Magnesium alloys powder
1418	138	Magnesium powder
1419	139	Magnesium aluminum phosphide
1420	138	Potassium metal alloys, liquid
1421	138	Alkali metal alloy, liquid, n.o.s.

ID No.	Guide No.	Name of Material
1422	138	Potassium sodium alloys, liquid
1423	138	Rubidium
1426	138	Sodium borohydride
1427	138	Sodium hydride
1428	138	Sodium
1431	138	Sodium methylate, dry
1432	139	Sodium phosphide
1433	139	Stannic phosphides
1435	138	Zinc ashes
1435	138	Zinc dross
1435	138	Zinc residue
1435	138	Zinc skimmings
1436	138	Zinc dust
1436	138	Zinc powder
1437	138	Zirconium hydride
1438	140	Aluminum nitrate
1439	141	Ammonium dichromate
1442	143	Ammonium perchlorate
1444	140	Ammonium persulfate
1444	140	Ammonium persulphate
1445	141	Barium chlorate, solid
1446	141	Barium nitrate
1447	141	Barium perchlorate, solid
1448	141	Barium permanganate
1449	141	Barium peroxide
1450	140	Bromates, inorganic, n.o.s.
1451	140	Caesium nitrate
1451	140	Cesium nitrate
1452	140	Calcium chlorate
1453	140	Calcium chlorite
1454	140	Calcium nitrate
1455	140	Calcium perchlorate

ID No.	Guide No.	Name of Material
1456	140	Calcium permanganate
1457	140	Calcium peroxide
1458	140	Chlorate and borate mixture
1459	140	Chlorate and magnesium chloride mixture, solid
1461	140	Chlorates, inorganic, n.o.s.
1462	143	Chlorites, inorganic, n.o.s.
1463	141	Chromium trioxide, anhydrous
1465	140	Didymium nitrate
1466	140	Ferric nitrate
1467	143	Guanidine nitrate
1469	141	Lead nitrate
1470	141	Lead perchlorate, solid
1471	140	Lithium hypochlorite, dry
1471	140	Lithium hypochlorite mixture
1472	143	Lithium peroxide
1473	140	Magnesium bromate
1474	140	Magnesium nitrate
1475	140	Magnesium perchlorate
1476	140	Magnesium peroxide
1477	140	Nitrates, inorganic, n.o.s.
1479	140	Oxidizing solid, n.o.s.
1481	140	Perchlorates, inorganic, n.o.s.
1482	140	Permanganates, inorganic, n.o.s.
1483	140	Peroxides, inorganic, n.o.s.
1484	140	Potassium bromate
1485	140	Potassium chlorate
1486	140	Potassium nitrate
1487	140	Potassium nitrate and sodium nitrite mixture
1488	140	Potassium nitrite
1489	140	Potassium perchlorate

ID No.	Guide No.	Name of Material
1490	140	Potassium permanganate
1491	144	Potassium peroxide
1492	140	Potassium persulfate
1492	140	Potassium persulphate
1493	140	Silver nitrate
1494	140	Sodium bromate
1495	140	Sodium chlorate
1496	143	Sodium chlorite
1498	140	Sodium nitrate
1499	140	Sodium nitrate and potassium nitrate mixture
1500	141	Sodium nitrite
1502	140	Sodium perchlorate
1503	140	Sodium permanganate
1504	144	Sodium peroxide
1505	140	Sodium persulfate
1505	140	Sodium persulphate
1506	143	Strontium chlorate
1507	140	Strontium nitrate
1508	140	Strontium perchlorate
1509	143	Strontium peroxide
1510	143	Tetranitromethane
1511	140	Urea hydrogen peroxide
1512	140	Zinc ammonium nitrite
1513	140	Zinc chlorate
1514	140	Zinc nitrate
1515	140	Zinc permanganate
1516	143	Zinc peroxide
1517	113	Zirconium picramate, wetted with not less than 20% water
1541	156	Acetone cyanohydrin, stabilized
1544	151	Alkaloids, solid, n.o.s. (poisonous)

ID No.	Guide No.	Name of Material
1544	151	Alkaloid salts, solid, n.o.s. (poisonous)
1545	131	Allyl isothiocyanate, stabilized
1546	151	Ammonium arsenate
1547	153	Aniline
1548	153	Aniline hydrochloride
1549	157	Antimony compound, inorganic, solid, n.o.s.
1550	151	Antimony lactate
1551	151	Antimony potassium tartrate
1553	154	Arsenic acid, liquid
1554	154	Arsenic acid, solid
1555	151	Arsenic bromide
1556	152	Arsenic compound, liquid, n.o.s.
1556	152	Methyldichloroarsine
1557	152	Arsenic compound, solid, n.o.s.
1558	152	Arsenic
1559	151	Arsenic pentoxide
1560	157	Arsenic chloride
1560	157	Arsenic trichloride
1561	151	Arsenic trioxide
1562	152	Arsenical dust
1564	154	Barium compound, n.o.s.
1565	157	Barium cyanide
1566	154	Beryllium compound, n.o.s.
1567	134	Beryllium powder
1569	131	Bromoacetone
1570	151	Brucine
1571	113	Barium azide, wetted with not less than 50% water
1572	151	Cacodylic acid
1573	151	Calcium arsenate

ID No.	Guide No.	Name of Material
1574	151	Calcium arsenate and calcium arsenite mixture, solid
1575	157	Calcium cyanide
1577	153	Chlorodinitrobenzenes, liquid
1578	152	Chloronitrobenzenes, solid
1579	153	4-Chloro-o-toluidine hydrochloride, solid
1580	154	Chloropicrin
1581	123	Chloropicrin and methyl bromide mixture
1582	119	Chloropicrin and methyl chloride mixture
1583	154	Chloropicrin mixture, n.o.s.
1585	151	Copper acetoarsenite
1586	151	Copper arsenite
1587	151	Copper cyanide
1588	157	Cyanides, inorganic, solid, n.o.s.
1589	125	Cyanogen chloride, stabilized
1590	153	Dichloroanilines, liquid
1591	152	o-Dichlorobenzene
1593	160	Dichloromethane
1593	160	Methylene chloride
1594	152	Diethyl sulfate
1594	152	Diethyl sulphate
1595	156	Dimethyl sulfate
1595	156	Dimethyl sulphate
1596	153	Dinitroanilines
1597	152	Dinitrobenzenes, liquid
1598	153	Dinitro-o-cresol
1599	153	Dinitrophenol, solution
1600	152	Dinitrotoluenes, molten
1601	151	Disinfectant, solid, poisonous, n.o.s.

ID No.	Guide No.	Name of Material
1601	151	Disinfectant, solid, toxic, n.o.s.
1602	151	Dye, liquid, poisonous, n.o.s.
1602	151	Dye, liquid, toxic, n.o.s.
1602	151	Dye intermediate, liquid, poisonous, n.o.s.
1602	151	Dye intermediate, liquid, toxic, n.o.s.
1603	155	Ethyl bromoacetate
1604	132	Ethylenediamine
1605	154	Ethylene dibromide
1606	151	Ferric arsenate
1607	151	Ferric arsenite
1608	151	Ferrous arsenate
1611	151	Hexaethyl tetraphosphate
1612	123	Hexaethyl tetraphosphate and compressed gas mixture
1613	154	Hydrocyanic acid, aqueous solution, with less than 5% hydrogen cyanide
1613	154	Hydrocyanic acid, aqueous solution, with not more than 20% hydrogen cyanide
1613	154	Hydrogen cyanide, aqueous solution, with not more than 20% hydrogen cyanide
1614	152	Hydrogen cyanide, stabilized (absorbed)
1616	151	Lead acetate
1617	151	Lead arsenates
1618	151	Lead arsenites
1620	151	Lead cyanide
1621	151	London purple
1622	151	Magnesium arsenate
1623	151	Mercuric arsenate
1624	154	Mercuric chloride
1625	141	Mercuric nitrate

ID No.	Guide No.	Name of Material
1626	157	Mercuric potassium cyanide
1627	141	Mercurous nitrate
1629	151	Mercury acetate
1630	151	Mercury ammonium chloride
1631	154	Mercury benzoate
1634	154	Mercury bromides
1636	154	Mercury cyanide
1637	151	Mercury gluconate
1638	151	Mercury iodide
1639	151	Mercury nucleate
1640	151	Mercury oleate
1641	151	Mercury oxide
1642	151	Mercury oxycyanide, desensitized
1643	151	Mercury potassium iodide
1644	151	Mercury salicylate
1645	151	Mercury sulfate
1645	151	Mercury sulphate
1646	151	Mercury thiocyanate
1647	151	Methyl bromide and ethylene dibromide mixture, liquid
1648	127	Acetonitrile
1649	152	Motor fuel anti-knock mixture
1650	153	beta-Naphthylamine, solid
1650	153	Naphthylamine (beta), solid
1651	153	Naphthylthiourea
1652	153	Naphthylurea
1653	151	Nickel cyanide
1654	151	Nicotine
1655	151	Nicotine compound, solid, n.o.s.
1655	151	Nicotine preparation, solid, n.o.s.
1656	151	Nicotine hydrochloride, liquid

ID No.	Guide No.	Name of Material
1656	151	Nicotine hydrochloride, solution
1657	151	Nicotine salicylate
1658	151	Nicotine sulfate, solution
1658	151	Nicotine sulphate, solution
1659	151	Nicotine tartrate
1660	124	Nitric oxide, compressed
1661	153	Nitroanilines
1662	152	Nitrobenzene
1663	153	Nitrophenols
1664	152	Nitrotoluenes, liquid
1665	152	Nitroxylenes, liquid
1669	151	Pentachloroethane
1670	157	Perchloromethyl mercaptan
1671	153	Phenol, solid
1672	151	Phenylcarbylamine chloride
1673	153	Phenylenediamines
1674	151	Phenylmercuric acetate
1677	151	Potassium arsenate
1678	154	Potassium arsenite
1679	157	Potassium cuprocyanide
1680	157	Potassium cyanide, solid
1683	151	Silver arsenite
1684	151	Silver cyanide
1685	151	Sodium arsenate
1686	154	Sodium arsenite, aqueous solution
1687	153	Sodium azide
1688	152	Sodium cacodylate
1689	157	Sodium cyanide, solid
1690	154	Sodium fluoride, solid
1691	151	Strontium arsenite
1692	151	Strychnine

ID No.	Guide No.	Name of Material
1692	151	Strychnine salts
1693	159	Tear gas devices
1693	159	Tear gas substance, liquid, n.o.s.
1694	159	Bromobenzyl cyanides, liquid
1695	131	Chloroacetone, stabilized
1697	153	Chloroacetophenone, solid
1698	154	Diphenylamine chloroarsine
1699	151	Diphenylchloroarsine, liquid
1700	159	Tear gas candles
1700	159	Tear gas grenades
1701	152	Xylyl bromide, liquid
1702	151	1,1,2,2-Tetrachloroethane
1704	153	Tetraethyl dithiopyrophosphate
1707	151	Thallium compound, n.o.s.
1708	153	Toluidines, liquid
1709	151	2,4-Toluenediamine, solid
1709	151	2,4-Toluylenediamine, solid
1710	160	Trichloroethylene
1711	153	Xylidines, liquid
1712	151	Zinc arsenate
1712	151	Zinc arsenate and zinc arsenite mixture
1712	151	Zinc arsenite
1713	151	Zinc cyanide
1714	139	Zinc phosphide
1715	137	Acetic anhydride
1716	156	Acetyl bromide
1717	155	Acetyl chloride
1718	153	Acid butyl phosphate
1718	153	Butyl acid phosphate
1719	154	Caustic alkali liquid, n.o.s.
1722	155	Allyl chlorocarbonate

ID No.	Guide No.	Name of Material
1722	155	Allyl chloroformate
1723	132	Allyl iodide
1724	155	Allyltrichlorosilane, stabilized
1725	137	Aluminum bromide, anhydrous
1726	137	Aluminum chloride, anhydrous
1727	154	Ammonium bifluoride, solid
1727	154	Ammonium hydrogendifluoride, solid
1728	156	Amyltrichlorosilane
1729	156	Anisoyl chloride
1730	157	Antimony pentachloride, liquid
1731	157	Antimony pentachloride, solution
1732	157	Antimony pentafluoride
1733	157	Antimony trichloride
1733	157	Antimony trichloride, liquid
1733	157	Antimony trichloride, solid
1736	137	Benzoyl chloride
1737	156	Benzyl bromide
1738	156	Benzyl chloride
1739	137	Benzyl chloroformate
1740	154	Hydrogendifluorides, solid, n.o.s.
1741	125	Boron trichloride
1742	157	Boron trifluoride acetic acid complex, liquid
1743	157	Boron trifluoride propionic acid complex, liquid
1744	154	Bromine
1744	154	Bromine, solution
1744	154	Bromine, solution (Inhalation Hazard Zone A)
1744	154	Bromine, solution (Inhalation Hazard Zone B)
1745	144	Bromine pentafluoride

ID Guide
No. No.

Name of Material

ID Guide
No. No.

Name of Material

1746	144	Bromine trifluoride
1747	155	Butyltrichlorosilane
1748	140	Calcium hypochlorite, dry
1748	140	Calcium hypochlorite mixture, dry, with more than 39% available chlorine (8.8% available oxygen)
1749	124	Chlorine trifluoride
1750	153	Chloroacetic acid, solution
1751	153	Chloroacetic acid, solid
1752	156	Chloroacetyl chloride
1753	156	Chlorophenyltrichlorosilane
1754	137	Chlorosulfonic acid (with or without sulfur trioxide)
1754	137	Chlorosulphonic acid (with or without sulphur trioxide)
1755	154	Chromic acid, solution
1756	154	Chromic fluoride, solid
1757	154	Chromic fluoride, solution
1758	137	Chromium oxychloride
1759	154	Corrosive solid, n.o.s.
1759	154	Ferrous chloride, solid
1760	154	Chemical kit
1760	154	Compounds, cleaning liquid (corrosive)
1760	154	Compounds, tree or weed killing, liquid (corrosive)
1760	154	Corrosive liquid, n.o.s.
1760	154	Ferrous chloride, solution
1761	154	Cupriethylenediamine, solution
1762	156	Cyclohexenyltrichlorosilane
1763	156	Cyclohexyltrichlorosilane
1764	153	Dichloroacetic acid
1765	156	Dichloroacetyl chloride
1766	156	Dichlorophenyltrichlorosilane

1767	155	Diethylchlorosilane
1768	154	Difluorophosphoric acid, anhydrous
1769	156	Diphenyldichlorosilane
1770	153	Diphenylmethyl bromide
1771	156	Dodecyltrichlorosilane
1773	157	Ferric chloride, anhydrous
1774	154	Fire extinguisher charges, corrosive liquid
1775	154	Fluoroboric acid
1776	154	Fluorophosphoric acid, anhydrous
1777	137	Fluorosulfonic acid
1777	137	Fluorosulphonic acid
1778	154	Fluorosilicic acid
1778	154	Hydrofluorosilicic acid
1779	153	Formic acid
1779	153	Formic acid, with more than 85% acid
1780	156	Fumaryl chloride
1781	156	Hexadecyltrichlorosilane
1782	154	Hexafluorophosphoric acid
1783	153	Hexamethylenediamine, solution
1784	156	Hexyltrichlorosilane
1786	157	Hydrofluoric acid and sulfuric acid mixture
1786	157	Hydrofluoric acid and sulphuric acid mixture
1786	157	Sulfuric acid and hydrofluoric acid mixture
1786	157	Sulphuric acid and hydrofluoric acid mixture
1787	154	Hydriodic acid
1788	154	Hydrobromic acid
1789	157	Hydrochloric acid

ID No.	Guide No.	Name of Material
1789	157	Muriatic acid
1790	157	Hydrofluoric acid
1791	154	Hypochlorite solution
1791	154	Sodium hypochlorite
1792	157	Iodine monochloride, solid
1793	153	Isopropyl acid phosphate
1794	154	Lead sulfate, with more than 3% free acid
1794	154	Lead sulphate, with more than 3% free acid
1796	157	Nitrating acid mixture with more than 50% nitric acid
1796	157	Nitrating acid mixture with not more than 50% nitric acid
1798	157	Aqua regia
1798	157	Nitrohydrochloric acid
1799	156	Nonyltrichlorosilane
1800	156	Octadecyltrichlorosilane
1801	156	Octyltrichlorosilane
1802	157	Perchloric acid, with not more than 50% acid
1803	153	Phenolsulfonic acid, liquid
1803	153	Phenolsulphonic acid, liquid
1804	156	Phenyltrichlorosilane
1805	154	Phosphoric acid, solution
1806	137	Phosphorus pentachloride
1807	137	Phosphorus pentoxide
1808	137	Phosphorus tribromide
1809	137	Phosphorus trichloride
1810	137	Phosphorus oxychloride
1811	154	Potassium hydrogen difluoride, solid
1812	154	Potassium fluoride, solid
1813	154	Caustic potash, solid

ID No.	Guide No.	Name of Material
1813	154	Potassium hydroxide, solid
1814	154	Caustic potash, solution
1814	154	Potassium hydroxide, solution
1815	155	Propionyl chloride
1816	155	Propyltrichlorosilane
1817	137	Pyrosulfuryl chloride
1817	137	Pyrosulphuryl chloride
1818	157	Silicon tetrachloride
1819	154	Sodium aluminate, solution
1823	154	Caustic soda, solid
1823	154	Sodium hydroxide, solid
1824	154	Caustic soda, solution
1824	154	Sodium hydroxide, solution
1825	157	Sodium monoxide
1826	157	Nitrating acid mixture, spent, with more than 50% nitric acid
1826	157	Nitrating acid mixture, spent, with not more than 50% nitric acid
1827	137	Stannic chloride, anhydrous
1827	137	Tin tetrachloride
1828	137	Sulfur chlorides
1828	137	Sulphur chlorides
1829	137	Sulfur trioxide, stabilized
1829	137	Sulphur trioxide, stabilized
1830	137	Sulfuric acid
1830	137	Sulfuric acid, with more than 51% acid
1830	137	Sulphuric acid
1830	137	Sulphuric acid, with more than 51% acid
1831	137	Sulfuric acid, fuming
1831	137	Sulphuric acid, fuming

ID No.	Guide No.	Name of Material
1832	137	Sulfuric acid, spent
1832	137	Sulphuric acid, spent
1833	154	Sulfurous acid
1833	154	Sulphurous acid
1834	137	Sulfuryl chloride
1834	137	Sulphuryl chloride
1835	153	Tetramethylammonium hydroxide aqueous solution with more than 2.5% but less than 25% tetramethylammonium hydroxide
1835	153	Tetramethylammonium hydroxide, solution
1836	137	Thionyl chloride
1837	157	Thiophosphoryl chloride
1838	137	Titanium tetrachloride
1839	153	Trichloroacetic acid
1840	154	Zinc chloride, solution
1841	171	Acetaldehyde ammonia
1843	141	Ammonium dinitro-o-cresolate, solid
1845	120	Carbon dioxide, solid
1845	120	Dry ice
1846	151	Carbon tetrachloride
1847	153	Potassium sulfide, hydrated, with not less than 30% water of crystallization
1847	153	Potassium sulphide, hydrated, with not less than 30% water of crystallization
1848	153	Propionic acid
1848	153	Propionic acid, with not less than 10% and less than 90% acid
1849	153	Sodium sulfide, hydrated, with not less than 30% water
1849	153	Sodium sulphide, hydrated, with not less than 30% water

ID No.	Guide No.	Name of Material
1851	151	Medicine, liquid, poisonous, n.o.s.
1851	151	Medicine, liquid, toxic, n.o.s.
1854	135	Barium alloys, pyrophoric
1855	135	Calcium, pyrophoric
1855	135	Calcium alloys, pyrophoric
1856	133	Rags, oily
1857	133	Textile waste, wet
1858	126	Hexafluoropropylene
1858	126	Hexafluoropropylene, compressed
1858	126	Refrigerant gas R-1216
1859	125	Silicon tetrafluoride
1859	125	Silicon tetrafluoride, compressed
1860	116P	Vinyl fluoride, stabilized
1862	130	Ethyl crotonate
1863	128	Fuel, aviation, turbine engine
1865	128	n-Propyl nitrate
1866	128	Resin solution
1868	134	Decaborane
1869	138	Magnesium
1869	138	Magnesium, in pellets, turnings or ribbons
1869	138	Magnesium alloys, with more than 50% magnesium, in pellets, turnings or ribbons
1870	138	Potassium borohydride
1871	170	Titanium hydride
1872	140	Lead dioxide
1873	143	Perchloric acid, with more than 50% but not more than 72% acid
1884	157	Barium oxide
1885	153	Benzidine

ID Guide
No. No.

1886 **156** Benzylidene chloride
1887 **160** Bromochloromethane
1888 **151** Chloroform
1889 **157** Cyanogen bromide
1891 **131** Ethyl bromide
1892 151 Ethyldichloroarsine
1894 **151** Phenylmercuric hydroxide
1895 **151** Phenylmercuric nitrate
1897 **160** Perchloroethylene
1897 **160** Tetrachloroethylene
1898 156 Acetyl iodide
1902 **153** Diisooctyl acid phosphate
1903 **153** Disinfectant, liquid, corrosive,
n.o.s.
1905 **154** Selenic acid
1906 **153** Acid, sludge
1906 **153** Sludge acid
1907 **154** Soda lime, with more than 4%
sodium hydroxide
1908 **154** Chlorite solution
1910 **157** Calcium oxide
1911 119 Diborane
1911 119 Diborane mixtures
1912 **115** Methyl chloride and methylene
chloride mixture
1913 **120** Neon, refrigerated liquid
(cryogenic liquid)
1914 **130** Butyl propionates
1915 **127** Cyclohexanone
1916 **152** 2,2'-Dichlorodiethyl ether
1916 **152** Dichloroethyl ether
1917 **129P** Ethyl acrylate, stabilized
1918 **130** Cumene
1918 **130** Isopropylbenzene

ID Guide
No. No.

1919 **129P** Methyl acrylate, stabilized
1920 **128** Nonanes
1921 **131P** Propyleneimine, stabilized
1922 **132** Pyrrolidine
1923 135 Calcium dithionite
1923 135 Calcium hydrosulfite
1923 135 Calcium hydrosulphite
1928 **138** Methyl magnesium bromide in
ethyl ether
1929 135 Potassium dithionite
1929 135 Potassium hydrosulfite
1929 135 Potassium hydrosulphite
1931 171 Zinc dithionite
1931 171 Zinc hydrosulfite
1931 171 Zinc hydrosulphite
1932 **135** Zirconium scrap
1935 **157** Cyanide solution, n.o.s.
1938 **156** Bromoacetic acid, solution
1939 **137** Phosphorus oxybromide, solid
1940 **153** Thioglycolic acid
1941 **171** Dibromodifluoromethane
1941 **171** Refrigerant gas R-12B2
1942 **140** Ammonium nitrate, with not
more than 0.2% combustible
substances
1944 **133** Matches, safety
1945 **133** Matches, wax "vesta"
1950 **126** Aerosols
1951 **120** Argon, refrigerated liquid
(cryogenic liquid)
1952 **126** Ethylene oxide and carbon
dioxide mixture, with not
more than 9% ethylene oxide
1953 119 Compressed gas, poisonous,
flammable, n.o.s.

ID No.	Guide No.	Name of Material
--------	-----------	------------------

ID No.	Guide No.	Name of Material
--------	-----------	------------------

1953	119	Compressed gas, poisonous, flammable, n.o.s. (Inhalation Hazard Zone A)
------	-----	---

1955	123	Compressed gas, poisonous, n.o.s. (Inhalation Hazard Zone D)
------	-----	--

1953	119	Compressed gas, poisonous, flammable, n.o.s. (Inhalation Hazard Zone B)
------	-----	---

1955	123	Compressed gas, toxic, n.o.s.
------	-----	-------------------------------

1955	123	Compressed gas, toxic, n.o.s. (Inhalation Hazard Zone A)
------	-----	--

1953	119	Compressed gas, poisonous, flammable, n.o.s. (Inhalation Hazard Zone C)
------	-----	---

1955	123	Compressed gas, toxic, n.o.s. (Inhalation Hazard Zone B)
------	-----	--

1953	119	Compressed gas, poisonous, flammable, n.o.s. (Inhalation Hazard Zone D)
------	-----	---

1955	123	Compressed gas, toxic, n.o.s. (Inhalation Hazard Zone C)
------	-----	--

1955	123	Compressed gas, toxic, n.o.s. (Inhalation Hazard Zone D)
------	-----	--

1953	119	Compressed gas, toxic, flammable, n.o.s.
------	-----	--

1955	123	Organic phosphate compound mixed with compressed gas
------	-----	--

1953	119	Compressed gas, toxic, flammable, n.o.s. (Inhalation Hazard Zone A)
------	-----	---

1955	123	Organic phosphate mixed with compressed gas
------	-----	---

1953	119	Compressed gas, toxic, flammable, n.o.s. (Inhalation Hazard Zone B)
------	-----	---

1955	123	Organic phosphorus compound mixed with compressed gas
------	-----	---

1953	119	Compressed gas, toxic, flammable, n.o.s. (Inhalation Hazard Zone C)
------	-----	---

1956	126	Compressed gas, n.o.s.
------	-----	------------------------

1957	115	Deuterium, compressed
------	-----	-----------------------

1953	119	Compressed gas, toxic, flammable, n.o.s. (Inhalation Hazard Zone D)
------	-----	---

1958	126	1,2-Dichloro-1,1,2,2-tetrafluoroethane
------	-----	--

1958	126	Refrigerant gas R-114
------	-----	-----------------------

1954	115	Compressed gas, flammable, n.o.s.
------	-----	-----------------------------------

1959	116P	1,1-Difluoroethylene
------	------	----------------------

1959	116P	Refrigerant gas R-1132a
------	------	-------------------------

1954	115	Dispersant gases, n.o.s. (flammable)
------	-----	--------------------------------------

1961	115	Ethane, refrigerated liquid
------	-----	-----------------------------

1954	115	Refrigerant gases, n.o.s. (flammable)
------	-----	---------------------------------------

1961	115	Ethane-propane mixture, refrigerated liquid
------	-----	---

1955	123	Compressed gas, poisonous, n.o.s.
------	-----	-----------------------------------

1962	116P	Ethylene
------	------	----------

1962	116P	Ethylene, compressed
------	------	----------------------

1955	123	Compressed gas, poisonous, n.o.s. (Inhalation Hazard Zone A)
------	-----	--

1963	120	Helium, refrigerated liquid (cryogenic liquid)
------	-----	--

1955	123	Compressed gas, poisonous, n.o.s. (Inhalation Hazard Zone B)
------	-----	--

1964	115	Hydrocarbon gas mixture, compressed, n.o.s.
------	-----	---

1965	115	Hydrocarbon gas mixture, liquefied, n.o.s.
------	-----	--

1955	123	Compressed gas, poisonous, n.o.s. (Inhalation Hazard Zone C)
------	-----	--

1966	115	Hydrogen, refrigerated liquid (cryogenic liquid)
------	-----	--

ID No.	Guide No.	Name of Material
1967	123	Insecticide gas, poisonous, n.o.s.
1967	123	Insecticide gas, toxic, n.o.s.
1967	123	Parathion and compressed gas mixture
1968	126	Insecticide gas, n.o.s.
1969	115	Isobutane
1970	120	Krypton, refrigerated liquid (cryogenic liquid)
1971	115	Methane, compressed
1971	115	Natural gas, compressed
1972	115	Liquefied natural gas (cryogenic liquid)
1972	115	LNG (cryogenic liquid)
1972	115	Methane, refrigerated liquid (cryogenic liquid)
1972	115	Natural gas, refrigerated liquid (cryogenic liquid)
1973	126	Chlorodifluoromethane and chloropentafluoroethane mixture
1973	126	Refrigerant gas R-502
1974	126	Chlorodifluorobromomethane
1974	126	Refrigerant gas R-12B1
1975	124	Nitric oxide and dinitrogen tetroxide mixture
1975	124	Nitric oxide and nitrogen dioxide mixture
1976	126	Octafluorocyclobutane
1976	126	Refrigerant gas RC-318
1977	120	Nitrogen, refrigerated liquid (cryogenic liquid)
1978	115	Propane
1982	126	Refrigerant gas R-14
1982	126	Tetrafluoromethane
1983	126	1-Chloro-2,2,2-trifluoroethane

ID No.	Guide No.	Name of Material
1983	126	Refrigerant gas R-133a
1984	126	Refrigerant gas R-23
1984	126	Trifluoromethane
1986	131	Alcohols, flammable, poisonous, n.o.s.
1986	131	Alcohols, flammable, toxic, n.o.s.
1987	127	Alcohols, n.o.s.
1987	127	Denatured alcohol
1988	131P	Aldehydes, flammable, poisonous, n.o.s.
1988	131P	Aldehydes, flammable, toxic, n.o.s.
1989	129P	Aldehydes, n.o.s.
1990	171	Benzaldehyde
1991	131P	Chloroprene, stabilized
1992	131	Flammable liquid, poisonous, n.o.s.
1992	131	Flammable liquid, toxic, n.o.s.
1993	128	Combustible liquid, n.o.s.
1993	128	Compounds, cleaning liquid (flammable)
1993	128	Compounds, tree or weed killing, liquid (flammable)
1993	128	Diesel fuel
1993	128	Flammable liquid, n.o.s.
1993	128	Fuel oil
1994	136	Iron pentacarbonyl
1999	130	Asphalt
1999	130	Asphalt, cut back
1999	130	Tars, liquid
2000	133	Celluloid, in block, rods, rolls, sheets, tubes, etc., except scrap
2001	133	Cobalt naphthenates, powder
2002	135	Celluloid, scrap

ID No.	Guide No.	Name of Material
2004	135	Magnesium diamide
2006	135	Plastics, nitrocellulose-based, self-heating, n.o.s.
2008	135	Zirconium powder, dry
2009	135	Zirconium, dry, finished sheets, strip or coiled wire
2010	138	Magnesium hydride
2011	139	Magnesium phosphide
2012	139	Potassium phosphide
2013	139	Strontium phosphide
2014	140	Hydrogen peroxide, aqueous solution, with not less than 20% but not more than 60% hydrogen peroxide (stabilized as necessary)
2015	143	Hydrogen peroxide, aqueous solution, stabilized, with more than 60% hydrogen peroxide
2015	143	Hydrogen peroxide, stabilized
2016	151	Ammunition, poisonous, non-explosive
2016	151	Ammunition, toxic, non-explosive
2017	159	Ammunition, tear-producing, non-explosive
2018	152	Chloroanilines, solid
2019	152	Chloroanilines, liquid
2020	153	Chlorophenols, solid
2021	153	Chlorophenols, liquid
2022	153	Cresylic acid
2023	131P	Epichlorohydrin
2024	151	Mercury compound, liquid, n.o.s.
2025	151	Mercury compound, solid, n.o.s.
2026	151	Phenylmercuric compound, n.o.s.
2027	151	Sodium arsenite, solid

ID No.	Guide No.	Name of Material
2028	153	Bombs, smoke, non-explosive, with corrosive liquid, without initiating device
2029	132	Hydrazine, anhydrous
2030	153	Hydrazine, aqueous solution, with more than 37% hydrazine
2031	157	Nitric acid, other than red fuming, with more than 65% nitric acid
2031	157	Nitric acid, other than red fuming, with not more than 65% nitric acid
2032	157	Nitric acid, red fuming
2033	154	Potassium monoxide
2034	115	Hydrogen and methane mixture, compressed
2035	115	Refrigerant gas R-143a
2035	115	1,1,1-Trifluoroethane
2036	120	Xenon
2036	120	Xenon, compressed
2037	115	Gas cartridges
2037	115	Receptacles, small, containing gas
2038	152	Dinitrotoluenes, liquid
2044	115	2,2-Dimethylpropane
2045	130	Isobutyl aldehyde
2045	130	Isobutyraldehyde
2046	130	Cymenes
2047	129	Dichloropropenes
2048	130P	Dicyclopentadiene
2049	130	Diethylbenzene
2050	128	Diisobutylene, isomeric compounds
2051	132	2-Dimethylaminoethanol
2052	128	Dipentene

ID No.	Guide No.	Name of Material
2053	129	Methyl isobutyl carbinol
2054	132	Morpholine
2055	128P	Styrene monomer, stabilized
2056	127	Tetrahydrofuran
2057	128	Tripropylene
2058	129	Valeraldehyde
2059	127	Nitrocellulose solution, flammable
2067	140	Ammonium nitrate based fertilizer
2071	140	Ammonium nitrate based fertilizer
2073	125	Ammonia solution, with more than 35% but not more than 50% ammonia
2074	153P	Acrylamide, solid
2075	153	Chloral, anhydrous, stabilized
2076	153	Cresols, liquid
2077	153	alpha-Naphthylamine
2077	153	Naphthylamine (alpha)
2078	156	Toluene diisocyanate
2079	154	Diethylenetriamine
2186	125	Hydrogen chloride, refrigerated liquid
2187	120	Carbon dioxide, refrigerated liquid
2188	119	Arsine
2189	119	Dichlorosilane
2190	124	Oxygen difluoride, compressed
2191	123	Sulfuryl fluoride
2191	123	Sulphuryl fluoride
2192	119	Germane
2193	126	Hexafluoroethane
2193	126	Refrigerant gas R-116
2194	125	Selenium hexafluoride

ID No.	Guide No.	Name of Material
2195	125	Tellurium hexafluoride
2196	125	Tungsten hexafluoride
2197	125	Hydrogen iodide, anhydrous
2198	125	Phosphorus pentafluoride
2198	125	Phosphorus pentafluoride, compressed
2199	119	Phosphine
2200	116P	Propadiene, stabilized
2201	122	Nitrous oxide, refrigerated liquid
2202	117	Hydrogen selenide, anhydrous
2203	116	Silane
2204	119	Carbonyl sulfide
2204	119	Carbonyl sulphide
2205	153	Adiponitrile
2206	156	Isocyanate solution, poisonous, n.o.s.
2206	156	Isocyanate solution, toxic, n.o.s.
2206	156	Isocyanates, poisonous, n.o.s.
2206	156	Isocyanates, toxic, n.o.s.
2208	140	Bleaching powder
2208	140	Calcium hypochlorite mixture, dry, with more than 10% but not more than 39% available chlorine
2209	153	Formaldehyde, solution (corrosive)
2209	153	Formalin (corrosive)
2210	135	Maneb
2210	135	Maneb preparation, with not less than 60% maneb
2211	171	Polymeric beads, expandable
2212	171	Asbestos
2212	171	Asbestos, amphibole
2213	133	Paraformaldehyde

ID Guide
No. No.

Name of Material

ID Guide
No. No.

Name of Material

2214 **156** Phthalic anhydride
2215 **156** Maleic anhydride
2215 **156** Maleic anhydride, molten
2216 **171** Fish meal, stabilized
2216 **171** Fish scrap, stabilized
2217 **135** Seed cake, with not more than
1.5% oil and not more than
11% moisture
2218 **132P** Acrylic acid, stabilized
2219 **129** Allyl glycidyl ether
2222 **128** Anisole
2224 **152** Benzonitrile
2225 **156** Benzenesulfonyl chloride
2225 **156** Benzenesulphonyl chloride
2226 **156** Benzotrichloride
2227 **130P** n-Butyl methacrylate, stabilized
2232 **153** Chloroacetaldehyde
2232 **153** 2-Chloroethanal
2233 **152** Chloroanisidines
2234 **130** Chlorobenzotrifluorides
2235 **153** Chlorobenzyl chlorides, liquid
2236 **156** 3-Chloro-4-methylphenyl
isocyanate, liquid
2237 **153** Chloronitroanilines
2238 **129** Chlorotoluenes
2239 **153** Chlorotoluidines, solid
2240 **154** Chromosulfuric acid
2240 **154** Chromosulphuric acid
2241 **128** Cycloheptane
2242 **128** Cycloheptene
2243 **130** Cyclohexyl acetate
2244 **129** Cyclopentanol
2245 **128** Cyclopentanone

2246 **128** Cyclopentene
2247 **128** n-Decane
2248 **132** Di-n-butylamine
2249 **131** Dichlorodimethyl ether,
symmetrical
2250 **156** Dichlorophenyl isocyanates
2251 **128P** Bicyclo[2.2.1]hepta-2,5-diene,
stabilized
2251 **128P** 2,5-Norbornadiene, stabilized
2252 **127** 1,2-Dimethoxyethane
2253 **153** N,N-Dimethylaniline
2254 **133** Matches, fusee
2256 **130** Cyclohexene
2257 **138** Potassium
2258 **132** 1,2-Propylenediamine
2259 **153** Triethylenetetramine
2260 **132** Tripropylamine
2261 **153** Xylenols, solid
2262 **156** Dimethylcarbamoyl chloride
2263 **128** Dimethylcyclohexanes
2264 **132** N,N-Dimethylcyclohexylamine
2264 **132** Dimethylcyclohexylamine
2265 **129** N,N-Dimethylformamide
2266 **132** Dimethyl-N-propylamine
2267 **156** Dimethyl thiophosphoryl
chloride
2269 **153** 3,3'-Iminodipropylamine
2270 **132** Ethylamine, aqueous solution,
with not less than 50%
but not more than 70%
ethylamine
2271 **128** Ethyl amyl ketone
2272 **153** N-Ethylaniline
2273 **153** 2-Ethylaniline

ID No.	Guide No.	Name of Material
2274	153	N-Ethyl-N-benzylaniline
2275	129	2-Ethylbutanol
2276	132	2-Ethylhexylamine
2277	130P	Ethyl methacrylate, stabilized
2278	128	n-Heptene
2279	151	Hexachlorobutadiene
2280	153	Hexamethylenediamine, solid
2281	156	Hexamethylene diisocyanate
2282	129	Hexanols
2283	130P	Isobutyl methacrylate, stabilized
2284	131	Isobutyronitrile
2285	155	Isocyanatobenzotrifluorides
2286	128	Pentamethylheptane
2287	128	Isoheptenes
2288	128	Isohexenes
2289	153	Isophoronediamine
2290	156	Isophorone diisocyanate
2291	151	Lead compound, soluble, n.o.s.
2293	128	4-Methoxy-4-methylpentan-2-one
2294	153	N-Methylaniline
2295	131	Methyl chloroacetate
2296	128	Methylcyclohexane
2297	128	Methylcyclohexanone
2298	128	Methylcyclopentane
2299	156	Methyl dichloroacetate
2300	153	2-Methyl-5-ethylpyridine
2301	128	2-Methylfuran
2302	127	5-Methylhexan-2-one
2303	128	Isopropenylbenzene
2304	133	Naphthalene, molten
2305	153	Nitrobenzenesulfonic acid

ID No.	Guide No.	Name of Material
2305	153	Nitrobenzenesulphonic acid
2306	152	Nitrobenzotrifluorides, liquid
2307	152	3-Nitro-4-chlorobenzotrifluoride
2308	157	Nitrosylsulfuric acid, liquid
2308	157	Nitrosylsulphuric acid, liquid
2309	128P	Octadiene
2310	131	Pentane-2,4-dione
2311	153	Phenetidines
2312	153	Phenol, molten
2313	129	Picolines
2315	171	PCB, liquid
2315	171	Polychlorinated biphenyls, liquid
2316	157	Sodium cuprocyanide, solid
2317	157	Sodium cuprocyanide, solution
2318	135	Sodium hydrosulfide, with less than 25% water of crystallization
2318	135	Sodium hydrosulphide, with less than 25% water of crystallization
2319	128	Terpene hydrocarbons, n.o.s.
2320	153	Tetraethylenepentamine
2321	153	Trichlorobenzenes, liquid
2322	152	Trichlorobutene
2323	130	Triethyl phosphite
2324	128	Triisobutylene
2325	129	1,3,5-Trimethylbenzene
2326	153	Trimethylcyclohexylamine
2327	153	Trimethylhexamethylenediamines
2328	156	Trimethylhexamethylene diisocyanate
2329	130	Trimethyl phosphite
2330	128	Undecane
2331	154	Zinc chloride, anhydrous

ID Guide
No. No.

Name of Material

ID Guide
No. No.

Name of Material

2332 **129** Acetaldehyde oxime
2333 **131** Allyl acetate
2334 **131** Allylamine
2335 **131** Allyl ethyl ether
2336 **131** Allyl formate
2337 **131** Phenyl mercaptan
2338 **127** Benzotrifluoride
2339 **130** 2-Bromobutane
2340 **130** 2-Bromoethyl ethyl ether
2341 **130** 1-Bromo-3-methylbutane
2342 **130** Bromomethylpropanes
2343 **130** 2-Bromopentane
2344 **129** Bromopropanes
2345 **130** 3-Bromopropyne
2346 **127** Butanedione
2346 **127** Diacetyl
2347 **130** Butyl mercaptan
2348 **129P** Butyl acrylates, stabilized
2350 **127** Butyl methyl ether
2351 **129** Butyl nitrites
2352 **127P** Butyl vinyl ether, stabilized
2353 **155** Butyryl chloride
2354 **131** Chloromethyl ethyl ether
2356 **129** 2-Chloropropane
2357 **132** Cyclohexylamine
2358 **128P** Cyclooctatetraene
2359 **132** Diallylamine
2360 **131P** Diallyl ether
2361 **132** Diisobutylamine
2362 **130** 1,1-Dichloroethane
2363 **129** Ethyl mercaptan
2364 **128** n-Propylbenzene

2366 **128** Diethyl carbonate
2367 **130** alpha-Methylvaleraldehyde
2367 **130** Methyl valeraldehyde (alpha)
2368 **128** alpha-Pinene
2368 **128** Pinene (alpha)
2370 **128** 1-Hexene
2371 **128** Isopentenes
2372 **129** 1,2-Di-(dimethylamino) ethane
2373 **127** Diethoxymethane
2374 **127** 3,3-Diethoxypropene
2375 **129** Diethyl sulfide
2375 **129** Diethyl sulphide
2376 **127** 2,3-Dihydropyran
2377 **127** 1,1-Dimethoxyethane
2378 **131** 2-Dimethylaminoacetonitrile
2379 **132** 1,3-Dimethylbutylamine
2380 **127** Dimethyldiethoxysilane
2381 **131** Dimethyl disulfide
2381 **131** Dimethyl disulphide
2382 **131** Dimethylhydrazine, symmetrical
2383 **132** Dipropylamine
2384 **127** Di-n-propyl ether
2385 **129** Ethyl isobutyrate
2386 **132** 1-Ethylpiperidine
2387 **130** Fluorobenzene
2388 **130** Fluorotoluenes
2389 **128** Furan
2390 **129** 2-Iodobutane
2391 **129** Iodomethylpropanes
2392 **129** Iodopropanes
2393 **129** Isobutyl formate
2394 **129** Isobutyl propionate

ID No.	Guide No.	Name of Material
2395	155	Isobutyryl chloride
2396	131P	Methacrylaldehyde, stabilized
2397	127	3-Methylbutan-2-one
2398	127	Methyl tert-butyl ether
2399	132	1-Methylpiperidine
2400	130	Methyl isovalerate
2401	132	Piperidine
2402	130	Propanethiols
2403	129P	Isopropenyl acetate
2404	131	Propionitrile
2405	129	Isopropyl butyrate
2406	127	Isopropyl isobutyrate
2407	155	Isopropyl chloroformate
2409	129	Isopropyl propionate
2410	129	1,2,3,6-Tetrahydropyridine
2411	131	Butyronitrile
2412	130	Tetrahydrothiophene
2413	128	Tetrapropyl orthotitanate
2414	130	Thiophene
2416	129	Trimethyl borate
2417	125	Carbonyl fluoride
2418	125	Sulfur tetrafluoride
2418	125	Sulphur tetrafluoride
2419	116	Bromotrifluoroethylene
2420	125	Hexafluoroacetone
2421	124	Nitrogen trioxide
2422	126	Octafluorobut-2-ene
2422	126	Refrigerant gas R-1318
2424	126	Octafluoropropane
2424	126	Refrigerant gas R-218
2426	140	Ammonium nitrate, liquid (hot concentrated solution)

ID No.	Guide No.	Name of Material
2427	140	Potassium chlorate, aqueous solution
2428	140	Sodium chlorate, aqueous solution
2429	140	Calcium chlorate, aqueous solution
2430	153	Alkylphenols, solid, n.o.s. (including C2-C12 homologues)
2431	153	Anisidines
2432	153	N,N-Diethylaniline
2433	152	Chloronitrotoluenes, liquid
2434	156	Dibenzylchlorosilane
2435	156	Ethylphenyldichlorosilane
2436	129	Thioacetic acid
2437	156	Methylphenyldichlorosilane
2438	131	Trimethylacetyl chloride
2439	154	Sodium hydrogendifluoride
2440	154	Stannic chloride, pentahydrate
2441	135	Titanium trichloride, pyrophoric
2441	135	Titanium trichloride mixture, pyrophoric
2442	156	Trichloroacetyl chloride
2443	137	Vanadium oxytrichloride
2444	137	Vanadium tetrachloride
2446	153	Nitrocresols, solid
2447	136	Phosphorus, white, molten
2447	136	White phosphorus, molten
2448	133	Molten sulfur
2448	133	Molten sulphur
2448	133	Sulfur, molten
2448	133	Sulphur, molten
2451	122	Nitrogen trifluoride
2452	116P	Ethylacetylene, stabilized

ID Guide
No. No.

Name of Material

ID Guide
No. No.

Name of Material

2453 115 Ethyl fluoride
2453 115 Refrigerant gas R-161
2454 115 Methyl fluoride
2454 115 Refrigerant gas R-41
2455 116 Methyl nitrite
2456 130P 2-Chloropropene
2457 128 2,3-Dimethylbutane
2458 130 Hexadiene
2459 128 2-Methyl-1-butene
2460 128 2-Methyl-2-butene
2461 128 Methylpentadiene
2463 138 Aluminum hydride
2464 141 Beryllium nitrate
2465 140 Dichloroisocyanuric acid, dry
2465 140 Dichloroisocyanuric acid salts
2465 140 Sodium dichloroisocyanurate
2465 140 Sodium dichloro-s-triazinetriene
2466 143 Potassium superoxide
2468 140 Trichloroisocyanuric acid, dry
2469 140 Zinc bromate
2470 152 Phenylacetone nitrile, liquid
2471 154 Osmium tetroxide
2473 154 Sodium arsenilate
2474 156 Thiophosgene
2475 157 Vanadium trichloride
2477 131 Methyl isothiocyanate
2478 155 Isocyanate solution, flammable,
poisonous, n.o.s.
2478 155 Isocyanate solution, flammable,
toxic, n.o.s.
2478 155 Isocyanates, flammable,
poisonous, n.o.s.
2478 155 Isocyanates, flammable, toxic,
n.o.s.

2480 155P Methyl isocyanate
2481 155 Ethyl isocyanate
2482 155P n-Propyl isocyanate
2483 155P Isopropyl isocyanate
2484 155 tert-Butyl isocyanate
2485 155P n-Butyl isocyanate
2486 155P Isobutyl isocyanate
2487 155 Phenyl isocyanate
2488 155 Cyclohexyl isocyanate
2490 153 Dichloroisopropyl ether
2491 153 Ethanolamine
2491 153 Ethanolamine, solution
2491 153 Monoethanolamine
2493 132 Hexamethylenimine
2495 144 Iodine pentafluoride
2496 156 Propionic anhydride
2498 129 1,2,3,6-Tetrahydrobenzaldehyde
2501 152 Tris-(1-aziridinyl)phosphine
oxide, solution
2502 132 Valeryl chloride
2503 137 Zirconium tetrachloride
2504 159 Acetylene tetrabromide
2504 159 Tetrabromoethane
2505 154 Ammonium fluoride
2506 154 Ammonium hydrogen sulfate
2506 154 Ammonium hydrogen sulphate
2507 154 Chloroplatinic acid, solid
2508 156 Molybdenum pentachloride
2509 154 Potassium hydrogen sulfate
2509 154 Potassium hydrogen sulphate
2511 153 2-Chloropropionic acid
2512 152 Aminophenols

ID No.	Guide No.	Name of Material
2513	156	Bromoacetyl bromide
2514	130	Bromobenzene
2515	159	Bromoform
2516	151	Carbon tetrabromide
2517	115	1-Chloro-1,1-difluoroethane
2517	115	Difluorochloroethanes
2517	115	Refrigerant gas R-142b
2518	153	1,5,9-Cyclododecatriene
2520	130P	Cyclooctadienes
2521	131P	Diketene, stabilized
2522	153P	2-Dimethylaminoethyl methacrylate, stabilized
2524	129	Ethyl orthoformate
2525	156	Ethyl oxalate
2526	132	Furfurylamine
2527	129P	Isobutyl acrylate, stabilized
2528	130	Isobutyl isobutyrate
2529	132	Isobutyric acid
2531	153P	Methacrylic acid, stabilized
2533	156	Methyl trichloroacetate
2534	119	Methylchlorosilane
2535	132	4-Methylmorpholine
2535	132	N-Methylmorpholine
2536	127	Methyltetrahydrofuran
2538	133	Nitronaphthalene
2541	128	Terpinolene
2542	153	Tributylamine
2545	135	Hafnium powder, dry
2546	135	Titanium powder, dry
2547	143	Sodium superoxide
2548	124	Chlorine pentafluoride
2552	151	Hexafluoroacetone hydrate, liquid

ID No.	Guide No.	Name of Material
2554	130P	Methylallyl chloride
2555	113	Nitrocellulose with water, not less than 25% water
2556	113	Nitrocellulose with alcohol, not less than 25% alcohol
2557	133	Nitrocellulose mixture, with or without pigment
2557	133	Nitrocellulose mixture, with or without plasticizer
2558	131	Epibromohydrin
2560	129	2-Methylpentan-2-ol
2561	128	3-Methyl-1-butene
2564	153	Trichloroacetic acid, solution
2565	153	Dicyclohexylamine
2567	154	Sodium pentachlorophenate
2570	154	Cadmium compound
2571	156	Alkylsulfuric acids
2571	156	Alkylsulphuric acids
2572	153	Phenylhydrazine
2573	141	Thallium chlorate
2574	151	Tricresyl phosphate
2576	137	Phosphorus oxybromide, molten
2577	156	Phenylacetyl chloride
2578	157	Phosphorus trioxide
2579	153	Piperazine
2580	154	Aluminum bromide, solution
2581	154	Aluminum chloride, solution
2582	154	Ferric chloride, solution
2583	153	Alkyl sulfonic acids, solid, with more than 5% free sulfuric acid
2583	153	Alkyl sulphonic acids, solid, with more than 5% free sulphuric acid

ID No.	Guide No.	Name of Material
2583	153	Aryl sulfonic acids, solid, with more than 5% free sulfuric acid
2583	153	Aryl sulphonic acids, solid, with more than 5% free sulphuric acid
2584	153	Alkyl sulfonic acids, liquid, with more than 5% free sulfuric acid
2584	153	Alkyl sulphonic acids, liquid, with more than 5% free sulphuric acid
2584	153	Aryl sulfonic acids, liquid, with more than 5% free sulfuric acid
2584	153	Aryl sulphonic acids, liquid, with more than 5% free sulphuric acid
2585	153	Alkyl sulfonic acids, solid, with not more than 5% free sulfuric acid
2585	153	Alkyl sulphonic acids, solid, with not more than 5% free sulphuric acid
2585	153	Aryl sulfonic acids, solid, with not more than 5% free sulfuric acid
2585	153	Aryl sulphonic acids, solid, with not more than 5% free sulphuric acid
2586	153	Alkyl sulfonic acids, liquid, with not more than 5% free sulfuric acid
2586	153	Alkyl sulphonic acids, liquid, with not more than 5% free sulphuric acid
2586	153	Aryl sulfonic acids, liquid, with not more than 5% free sulfuric acid
2586	153	Aryl sulphonic acids, liquid, with not more than 5% free sulphuric acid
2587	153	Benzoquinone

ID No.	Guide No.	Name of Material
2588	151	Pesticide, solid, poisonous, n.o.s.
2588	151	Pesticide, solid, toxic, n.o.s.
2589	155	Vinyl chloroacetate
2590	171	Asbestos, chrysotile
2591	120	Xenon, refrigerated liquid (cryogenic liquid)
2599	126	Chlorotrifluoromethane and trifluoromethane azeotropic mixture with approximately 60% chlorotrifluoromethane
2599	126	Refrigerant gas R-503
2601	115	Cyclobutane
2602	126	Dichlorodifluoromethane and difluoroethane azeotropic mixture with approximately 74% dichlorodifluoromethane
2602	126	Refrigerant gas R-500
2603	131	Cycloheptatriene
2604	132	Boron trifluoride diethyl etherate
2605	155	Methoxymethyl isocyanate
2606	155	Methyl orthosilicate
2607	129P	Acrolein dimer, stabilized
2608	129	Nitropropanes
2609	156	Triallyl borate
2610	132	Triallylamine
2611	131	Propylene chlorohydrin
2612	127	Methyl propyl ether
2614	129	Methallyl alcohol
2615	127	Ethyl propyl ether
2616	129	Triisopropyl borate
2617	129	Methylcyclohexanols
2618	130P	Vinyltoluenes, stabilized
2619	132	Benzyl dimethylamine
2620	130	Amyl butyrates

ID No.	Guide No.	Name of Material
2621	127	Acetyl methyl carbinol
2622	131P	Glycidaldehyde
2623	133	Firelighters, solid, with flammable liquid
2624	138	Magnesium silicide
2626	140	Chloric acid, aqueous solution, with not more than 10% chloric acid
2627	140	Nitrites, inorganic, n.o.s.
2628	151	Potassium fluoroacetate
2629	151	Sodium fluoroacetate
2630	151	Selenates
2630	151	Selenites
2642	154	Fluoroacetic acid
2643	153	Methyl bromoacetate
2644	151	Methyl iodide
2645	153	Phenacyl bromide
2646	151	Hexachlorocyclopentadiene
2647	153	Malononitrile
2648	154	1,2-Dibromobutan-3-one
2649	153	1,3-Dichloroacetone
2650	153	1,1-Dichloro-1-nitroethane
2651	153	4,4'-Diaminodiphenylmethane
2653	156	Benzyl iodide
2655	151	Potassium fluorosilicate
2656	154	Quinoline
2657	153	Selenium disulfide
2657	153	Selenium disulphide
2659	151	Sodium chloroacetate
2660	153	Mononitrotoluidines
2660	153	Nitrotoluidines (mono)
2661	153	Hexachloroacetone
2664	160	Dibromomethane

ID No.	Guide No.	Name of Material
2667	152	Butyltoluenes
2668	131	Chloroacetonitrile
2669	152	Chlorocresols, solution
2670	157	Cyanuric chloride
2671	153	Aminopyridines
2672	154	Ammonia solution, with more than 10% but not more than 35% ammonia
2672	154	Ammonium hydroxide, with more than 10% but not more than 35% ammonia
2673	151	2-Amino-4-chlorophenol
2674	154	Sodium fluorosilicate
2676	119	Stibine
2677	154	Rubidium hydroxide, solution
2678	154	Rubidium hydroxide, solid
2679	154	Lithium hydroxide, solution
2680	154	Lithium hydroxide
2681	154	Caesium hydroxide, solution
2681	154	Cesium hydroxide, solution
2682	157	Caesium hydroxide
2682	157	Cesium hydroxide
2683	132	Ammonium sulfide, solution
2683	132	Ammonium sulphide, solution
2684	132	3-Diethylaminopropylamine
2685	132	N,N-Diethylethylenediamine
2686	132	2-Diethylaminoethanol
2687	133	Dicyclohexylammonium nitrite
2688	159	1-Bromo-3-chloropropane
2689	153	Glycerol alpha-monochlorohydrin
2690	152	N,n-Butylimidazole
2691	137	Phosphorus pentabromide
2692	157	Boron tribromide

ID No.	Guide No.	Name of Material
2693	154	Bisulfites, aqueous solution, n.o.s.
2693	154	Bisulphites, aqueous solution, n.o.s.
2698	156	Tetrahydrophthalic anhydrides
2699	154	Trifluoroacetic acid
2705	153P	1-Pentol
2707	127	Dimethyldioxanes
2709	128	Butylbenzenes
2710	128	Dipropyl ketone
2713	153	Acridine
2714	133	Zinc resinate
2715	133	Aluminum resinate
2716	153	1,4-Butynediol
2717	133	Camphor, synthetic
2719	141	Barium bromate
2720	141	Chromium nitrate
2721	140	Copper chlorate
2722	140	Lithium nitrate
2723	140	Magnesium chlorate
2724	140	Manganese nitrate
2725	140	Nickel nitrate
2726	140	Nickel nitrite
2727	141	Thallium nitrate
2728	140	Zirconium nitrate
2729	152	Hexachlorobenzene
2730	152	Nitroanisoles, liquid
2732	152	Nitrobromobenzenes, liquid
2733	132	Amines, flammable, corrosive, n.o.s.
2733	132	Polyamines, flammable, corrosive, n.o.s.
2734	132	Amines, liquid, corrosive, flammable, n.o.s.

ID No.	Guide No.	Name of Material
2734	132	Polyamines, liquid, corrosive, flammable, n.o.s.
2735	153	Amines, liquid, corrosive, n.o.s.
2735	153	Polyamines, liquid, corrosive, n.o.s.
2738	153	N-Butylaniline
2739	156	Butyric anhydride
2740	155	n-Propyl chloroformate
2741	141	Barium hypochlorite, with more than 22% available chlorine
2742	155	Chloroformates, poisonous, corrosive, flammable, n.o.s.
2742	155	Chloroformates, toxic, corrosive, flammable, n.o.s.
2743	155	n-Butyl chloroformate
2744	155	Cyclobutyl chloroformate
2745	157	Chloromethyl chloroformate
2746	156	Phenyl chloroformate
2747	156	tert-Butylcyclohexyl chloroformate
2748	156	2-Ethylhexyl chloroformate
2749	130	Tetramethylsilane
2750	153	1,3-Dichloropropanol-2
2751	156	Diethylthiophosphoryl chloride
2752	127	1,2-Epoxy-3-ethoxypropane
2753	153	N-Ethylbenzyltoluidines, liquid
2754	153	N-Ethyltoluidines
2757	151	Carbamate pesticide, solid, poisonous
2757	151	Carbamate pesticide, solid, toxic
2758	131	Carbamate pesticide, liquid, flammable, poisonous
2758	131	Carbamate pesticide, liquid, flammable, toxic

ID No.	Guide No.	Name of Material
2759	151	Arsenical pesticide, solid, poisonous
2759	151	Arsenical pesticide, solid, toxic
2760	131	Arsenical pesticide, liquid, flammable, poisonous
2760	131	Arsenical pesticide, liquid, flammable, toxic
2761	151	Organochlorine pesticide, solid, poisonous
2761	151	Organochlorine pesticide, solid, toxic
2762	131	Organochlorine pesticide, liquid, flammable, poisonous
2762	131	Organochlorine pesticide, liquid, flammable, toxic
2763	151	Triazine pesticide, solid, poisonous
2763	151	Triazine pesticide, solid, toxic
2764	131	Triazine pesticide, liquid, flammable, poisonous
2764	131	Triazine pesticide, liquid, flammable, toxic
2771	151	Thiocarbamate pesticide, solid, poisonous
2771	151	Thiocarbamate pesticide, solid, toxic
2772	131	Thiocarbamate pesticide, liquid, flammable, poisonous
2772	131	Thiocarbamate pesticide, liquid, flammable, toxic
2775	151	Copper based pesticide, solid, poisonous
2775	151	Copper based pesticide, solid, toxic
2776	131	Copper based pesticide, liquid, flammable, poisonous
2776	131	Copper based pesticide, liquid, flammable, toxic

ID No.	Guide No.	Name of Material
2777	151	Mercury based pesticide, solid, poisonous
2777	151	Mercury based pesticide, solid, toxic
2778	131	Mercury based pesticide, liquid, flammable, poisonous
2778	131	Mercury based pesticide, liquid, flammable, toxic
2779	153	Substituted nitrophenol pesticide, solid, poisonous
2779	153	Substituted nitrophenol pesticide, solid, toxic
2780	131	Substituted nitrophenol pesticide, liquid, flammable, poisonous
2780	131	Substituted nitrophenol pesticide, liquid, flammable, toxic
2781	151	Bipyridilium pesticide, solid, poisonous
2781	151	Bipyridilium pesticide, solid, toxic
2782	131	Bipyridilium pesticide, liquid, flammable, poisonous
2782	131	Bipyridilium pesticide, liquid, flammable, toxic
2783	152	Organophosphorus pesticide, solid, poisonous
2783	152	Organophosphorus pesticide, solid, toxic
2784	131	Organophosphorus pesticide, liquid, flammable, poisonous
2784	131	Organophosphorus pesticide, liquid, flammable, toxic
2785	152	4-Thiapentanal
2786	153	Organotin pesticide, solid, poisonous
2786	153	Organotin pesticide, solid, toxic
2787	131	Organotin pesticide, liquid, flammable, poisonous

ID No.	Guide No.	Name of Material
2787	131	Organotin pesticide, liquid, flammable, toxic
2788	153	Organotin compound, liquid, n.o.s.
2789	132	Acetic acid, glacial
2789	132	Acetic acid, solution, more than 80% acid
2790	153	Acetic acid, solution, more than 10% but not more than 80% acid
2793	170	Ferrous metal borings, shavings, turnings or cuttings
2794	154	Batteries, wet, filled with acid
2795	154	Batteries, wet, filled with alkali
2796	157	Battery fluid, acid
2796	157	Sulfuric acid, with not more than 51% acid
2796	157	Sulphuric acid, with not more than 51% acid
2797	154	Battery fluid, alkali
2798	137	Benzene phosphorus dichloride
2798	137	Phenylphosphorus dichloride
2799	137	Benzene phosphorus thiodichloride
2799	137	Phenylphosphorus thiodichloride
2800	154	Batteries, wet, non-spillable
2801	154	Dye, liquid, corrosive, n.o.s.
2801	154	Dye intermediate, liquid, corrosive, n.o.s.
2802	154	Copper chloride
2803	172	Gallium
2805	138	Lithium hydride, fused solid
2806	139	Lithium nitride
2807	171	Magnetized material
2809	172	Mercury

ID No.	Guide No.	Name of Material
2810	153	Compounds, tree or weed killing, liquid (toxic)
2810	153	Poisonous liquid, organic, n.o.s.
2810	153	Toxic liquid, organic, n.o.s.
2811	154	Poisonous solid, organic, n.o.s.
2811	154	Toxic solid, organic, n.o.s.
2812	154	Sodium aluminate, solid
2813	138	Water-reactive solid, n.o.s.
2814	158	Infectious substance, affecting humans
2815	153	N-Aminoethylpiperazine
2817	154	Ammonium bifluoride, solution
2817	154	Ammonium hydrogendifluoride, solution
2818	154	Ammonium polysulfide, solution
2818	154	Ammonium polysulphide, solution
2819	153	Amyl acid phosphate
2820	153	Butyric acid
2821	153	Phenol solution
2822	153	2-Chloropyridine
2823	153	Crotonic acid, solid
2826	155	Ethyl chlorothioformate
2829	153	Caproic acid
2829	153	Hexanoic acid
2830	139	Lithium ferrosilicon
2831	160	1,1,1-Trichloroethane
2834	154	Phosphorous acid
2835	138	Sodium aluminum hydride
2837	154	Bisulfates, aqueous solution
2837	154	Bisulphates, aqueous solution
2837	154	Sodium bisulfate, solution
2837	154	Sodium bisulphate, solution
2838	129P	Vinyl butyrate, stabilized

ID No.	Guide No.	Name of Material
2839	153	Aldol
2840	129	Butyraldoxime
2841	131	Di-n-amylamine
2842	129	Nitroethane
2844	138	Calcium manganese silicon
2845	135	Ethyl phosphonous dichloride, anhydrous
2845	135	Methyl phosphonous dichloride
2845	135	Pyrophoric liquid, organic, n.o.s.
2846	135	Pyrophoric solid, organic, n.o.s.
2849	153	3-Chloropropanol-1
2850	128	Propylene tetramer
2851	157	Boron trifluoride, dihydrate
2852	113	Dipicryl sulfide, wetted with not less than 10% water
2852	113	Dipicryl sulphide, wetted with not less than 10% water
2853	151	Magnesium fluorosilicate
2854	151	Ammonium fluorosilicate
2854	151	Ammonium silicofluoride
2855	151	Zinc fluorosilicate
2855	151	Zinc silicofluoride
2856	151	Fluorosilicates, n.o.s.
2857	126	Refrigerating machines, containing ammonia solutions (UN2672)
2857	126	Refrigerating machines, containing non-flammable, non-poisonous gases
2857	126	Refrigerating machines, containing non-flammable, non-toxic gases
2858	170	Zirconium, dry, coiled wire, finished metal sheets, strip
2859	154	Ammonium metavanadate

ID No.	Guide No.	Name of Material
2861	151	Ammonium polyvanadate
2862	151	Vanadium pentoxide
2863	154	Sodium ammonium vanadate
2864	151	Potassium metavanadate
2865	154	Hydroxylamine sulfate
2865	154	Hydroxylamine sulphate
2869	157	Titanium trichloride mixture
2870	135	Aluminum borohydride
2870	135	Aluminum borohydride in devices
2871	170	Antimony powder
2872	159	Dibromochloropropanes
2873	153	Dibutylaminoethanol
2874	153	Furfuryl alcohol
2875	151	Hexachlorophene
2876	153	Resorcinol
2878	170	Titanium sponge granules
2878	170	Titanium sponge powders
2879	157	Selenium oxychloride
2880	140	Calcium hypochlorite, hydrated, with not less than 5.5% but not more than 16% water
2880	140	Calcium hypochlorite, hydrated mixture, with not less than 5.5% but not more than 16% water
2881	135	Metal catalyst, dry
2881	135	Nickel catalyst, dry
2900	158	Infectious substance, affecting animals only
2901	124	Bromine chloride
2902	151	Pesticide, liquid, poisonous, n.o.s.
2902	151	Pesticide, liquid, toxic, n.o.s.
2903	131	Pesticide, liquid, poisonous, flammable, n.o.s.

ID No.	Guide No.	Name of Material
2903	131	Pesticide, liquid, toxic, flammable, n.o.s.
2904	154	Chlorophenolates, liquid
2904	154	Phenolates, liquid
2905	154	Chlorophenolates, solid
2905	154	Phenolates, solid
2907	133	Isosorbide dinitrate mixture
2908	161	Radioactive material, excepted package, empty packaging
2909	161	Radioactive material, excepted package, articles manufactured from depleted uranium
2909	161	Radioactive material, excepted package, articles manufactured from natural thorium
2909	161	Radioactive material, excepted package, articles manufactured from natural uranium
2910	161	Radioactive material, excepted package, limited quantity of material
2911	161	Radioactive material, excepted package, articles
2911	161	Radioactive material, excepted package, instruments
2912	162	Radioactive material, low specific activity (LSA-I), non fissile or fissile-excepted
2913	162	Radioactive material, surface contaminated objects (SCO-I, SCO-II or SCO-III), non fissile or fissile-excepted
2915	163	Radioactive material, Type A package, non-special form, non fissile or fissile-excepted
2916	163	Radioactive material, Type B(U) package, non fissile or fissile-excepted

ID No.	Guide No.	Name of Material
2917	163	Radioactive material, Type B(M) package, non fissile or fissile-excepted
2919	163	Radioactive material, transported under special arrangement, non fissile or fissile-excepted
2920	132	Corrosive liquid, flammable, n.o.s.
2921	134	Corrosive solid, flammable, n.o.s.
2922	154	Corrosive liquid, poisonous, n.o.s.
2922	154	Corrosive liquid, toxic, n.o.s.
2923	154	Corrosive solid, poisonous, n.o.s.
2923	154	Corrosive solid, toxic, n.o.s.
2924	132	Flammable liquid, corrosive, n.o.s.
2925	134	Flammable solid, corrosive, organic, n.o.s.
2926	134	Flammable solid, poisonous, organic, n.o.s.
2926	134	Flammable solid, toxic, organic, n.o.s.
2927	154	Ethyl phosphonothioic dichloride, anhydrous
2927	154	Ethyl phosphorodichloridate
2927	154	Poisonous liquid, corrosive, organic, n.o.s.
2927	154	Toxic liquid, corrosive, organic, n.o.s.
2928	154	Poisonous solid, corrosive, organic, n.o.s.
2928	154	Toxic solid, corrosive, organic, n.o.s.
2929	131	Poisonous liquid, flammable, organic, n.o.s.
2929	131	Toxic liquid, flammable, organic, n.o.s.

ID No.	Guide No.	Name of Material
2930	134	Poisonous solid, flammable, organic, n.o.s.
2930	134	Toxic solid, flammable, organic, n.o.s.
2931	151	Vanadyl sulfate
2931	151	Vanadyl sulphate
2933	129	Methyl 2-chloropropionate
2934	129	Isopropyl 2-chloropropionate
2935	129	Ethyl 2-chloropropionate
2936	153	Thiolactic acid
2937	153	alpha-Methylbenzyl alcohol, liquid
2937	153	Methylbenzyl (alpha) alcohol, liquid
2940	135	Cyclooctadiene phosphines
2940	135	9-Phosphabicyclononanes
2941	153	Fluoroanilines
2942	153	2-Trifluoromethylaniline
2943	129	Tetrahydrofurfurylamine
2945	132	N-Methylbutylamine
2946	153	2-Amino-5-diethylaminopentane
2947	127	Isopropyl chloroacetate
2948	153	3-Trifluoromethylaniline
2949	154	Sodium hydrosulfide, hydrated, with not less than 25% water of crystallization
2949	154	Sodium hydrosulfide, with not less than 25% water of crystallization
2949	154	Sodium hydrosulphide, hydrated, with not less than 25% water of crystallization
2949	154	Sodium hydrosulphide, with not less than 25% water of crystallization
2950	138	Magnesium granules, coated

ID No.	Guide No.	Name of Material
2956	149	5-tert-Butyl-2,4,6-trinitro-m-xylene
2956	149	Musk xylene
2965	139	Boron trifluoride dimethyl etherate
2966	153	Thioglycol
2967	154	Sulfamic acid
2967	154	Sulphamic acid
2968	135	Maneb, stabilized
2968	135	Maneb preparation, stabilized
2969	171	Castor beans, meal, pomace or flake
2977	166	Radioactive material, uranium hexafluoride, fissile
2977	166	Uranium hexafluoride, radioactive material, fissile
2978	166	Radioactive material, uranium hexafluoride, non fissile or fissile-excepted
2978	166	Uranium hexafluoride, radioactive material, non fissile or fissile-excepted
2983	131P	Ethylene oxide and propylene oxide mixture, with not more than 30% ethylene oxide
2984	140	Hydrogen peroxide, aqueous solution, with not less than 8% but less than 20% hydrogen peroxide
2985	155	Chlorosilanes, flammable, corrosive, n.o.s.
2986	155	Chlorosilanes, corrosive, flammable, n.o.s.
2987	156	Chlorosilanes, corrosive, n.o.s.
2988	139	Chlorosilanes, water-reactive, flammable, corrosive, n.o.s.
2989	133	Lead phosphite, dibasic
2990	171	Life-saving appliances, self-inflating

ID No.	Guide No.	Name of Material	ID No.	Guide No.	Name of Material
2991	131	Carbamate pesticide, liquid, poisonous, flammable	3006	151	Thiocarbamate pesticide, liquid, poisonous
2991	131	Carbamate pesticide, liquid, toxic, flammable	3006	151	Thiocarbamate pesticide, liquid, toxic
2992	151	Carbamate pesticide, liquid, poisonous	3009	131	Copper based pesticide, liquid, poisonous, flammable
2992	151	Carbamate pesticide, liquid, toxic	3009	131	Copper based pesticide, liquid, toxic, flammable
2993	131	Arsenical pesticide, liquid, poisonous, flammable	3010	151	Copper based pesticide, liquid, poisonous
2993	131	Arsenical pesticide, liquid, toxic, flammable	3010	151	Copper based pesticide, liquid, toxic
2994	151	Arsenical pesticide, liquid, poisonous	3011	131	Mercury based pesticide, liquid, poisonous, flammable
2994	151	Arsenical pesticide, liquid, toxic	3011	131	Mercury based pesticide, liquid, toxic, flammable
2995	131	Organochlorine pesticide, liquid, poisonous, flammable	3012	151	Mercury based pesticide, liquid, poisonous
2995	131	Organochlorine pesticide, liquid, toxic, flammable	3012	151	Mercury based pesticide, liquid, toxic
2996	151	Organochlorine pesticide, liquid, poisonous	3013	131	Substituted nitrophenol pesticide, liquid, poisonous, flammable
2996	151	Organochlorine pesticide, liquid, toxic	3013	131	Substituted nitrophenol pesticide, liquid, toxic, flammable
2997	131	Triazine pesticide, liquid, poisonous, flammable	3014	153	Substituted nitrophenol pesticide, liquid, poisonous
2997	131	Triazine pesticide, liquid, toxic, flammable	3014	153	Substituted nitrophenol pesticide, liquid, toxic
2998	151	Triazine pesticide, liquid, poisonous	3015	131	Bipyridilium pesticide, liquid, poisonous, flammable
2998	151	Triazine pesticide, liquid, toxic	3015	131	Bipyridilium pesticide, liquid, toxic, flammable
3002	151	Phenyl urea pesticides, liquid, poisonous	3016	151	Bipyridilium pesticide, liquid, poisonous
3002	151	Phenyl urea pesticides, liquid, toxic	3016	151	Bipyridilium pesticide, liquid, toxic
3005	131	Thiocarbamate pesticide, liquid, poisonous, flammable	3017	131	Organophosphorus pesticide, liquid, poisonous, flammable
3005	131	Thiocarbamate pesticide, liquid, toxic, flammable			

ID No.	Guide No.	Name of Material
3017	131	Organophosphorus pesticide, liquid, toxic, flammable
3018	152	Organophosphorus pesticide, liquid, poisonous
3018	152	Organophosphorus pesticide, liquid, toxic
3019	131	Organotin pesticide, liquid, poisonous, flammable
3019	131	Organotin pesticide, liquid, toxic, flammable
3020	153	Organotin pesticide, liquid, poisonous
3020	153	Organotin pesticide, liquid, toxic
3021	131	Pesticide, liquid, flammable, poisonous, n.o.s.
3021	131	Pesticide, liquid, flammable, toxic, n.o.s.
3022	127P	1,2-Butylene oxide, stabilized
3023	131	2-Methyl-2-heptanethiol
3024	131	Coumarin derivative pesticide, liquid, flammable, poisonous
3024	131	Coumarin derivative pesticide, liquid, flammable, toxic
3025	131	Coumarin derivative pesticide, liquid, poisonous, flammable
3025	131	Coumarin derivative pesticide, liquid, toxic, flammable
3026	151	Coumarin derivative pesticide, liquid, poisonous
3026	151	Coumarin derivative pesticide, liquid, toxic
3027	151	Coumarin derivative pesticide, solid, poisonous
3027	151	Coumarin derivative pesticide, solid, toxic
3028	154	Batteries, dry, containing potassium hydroxide solid
3048	157	Aluminum phosphide pesticide
3054	129	Cyclohexanethiol

ID No.	Guide No.	Name of Material
3054	129	Cyclohexyl mercaptan
3055	154	2-(2-Aminoethoxy)ethanol
3056	129	n-Heptaldehyde
3057	125	Trifluoroacetyl chloride
3064	127	Nitroglycerin, solution in alcohol, with more than 1% but not more than 5% nitroglycerin
3065	127	Alcoholic beverages
3066	153	Paint (corrosive)
3066	153	Paint related material (corrosive)
3070	126	Ethylene oxide and dichlorodifluoromethane mixture, with not more than 12.5% ethylene oxide
3071	131	Mercaptan mixture, liquid, poisonous, flammable, n.o.s.
3071	131	Mercaptan mixture, liquid, toxic, flammable, n.o.s.
3071	131	Mercaptans, liquid, poisonous, flammable, n.o.s.
3071	131	Mercaptans, liquid, toxic, flammable, n.o.s.
3072	171	Life-saving appliances, not self-inflating
3073	131P	Vinylpyridines, stabilized
3077	171	Environmentally hazardous substance, solid, n.o.s.
3077	171	Hazardous waste, solid, n.o.s.
3077	171	Other regulated substances, solid, n.o.s.
3078	138	Cerium, turnings or gritty powder
3079	131P	Methacrylonitrile, stabilized
3080	155	Isocyanate solution, poisonous, flammable, n.o.s.
3080	155	Isocyanate solution, toxic, flammable, n.o.s.

ID No.	Guide No.	Name of Material
3080	155	Isocyanates, poisonous, flammable, n.o.s.
3080	155	Isocyanates, toxic, flammable, n.o.s.
3082	171	Environmentally hazardous substance, liquid, n.o.s.
3082	171	Hazardous waste, liquid, n.o.s.
3082	171	Other regulated substances, liquid, n.o.s.
3083	124	Perchloryl fluoride
3084	157	Corrosive solid, oxidizing, n.o.s.
3085	140	Oxidizing solid, corrosive, n.o.s.
3086	141	Poisonous solid, oxidizing, n.o.s.
3086	141	Toxic solid, oxidizing, n.o.s.
3087	141	Oxidizing solid, poisonous, n.o.s.
3087	141	Oxidizing solid, toxic, n.o.s.
3088	135	Self-heating solid, organic, n.o.s.
3089	170	Metal powder, flammable, n.o.s.
3090	138	Lithium metal batteries (including lithium alloy batteries)
3091	138	Lithium metal batteries contained in equipment (including lithium alloy batteries)
3091	138	Lithium metal batteries packed with equipment (including lithium alloy batteries)
3092	129	1-Methoxy-2-propanol
3093	157	Corrosive liquid, oxidizing, n.o.s.
3094	138	Corrosive liquid, water-reactive, n.o.s.
3095	136	Corrosive solid, self-heating, n.o.s.

ID No.	Guide No.	Name of Material
3096	138	Corrosive solid, water-reactive, n.o.s.
3097	140	Flammable solid, oxidizing, n.o.s.
3098	140	Oxidizing liquid, corrosive, n.o.s.
3099	142	Oxidizing liquid, poisonous, n.o.s.
3099	142	Oxidizing liquid, toxic, n.o.s.
3100	135	Oxidizing solid, self-heating, n.o.s.
3101	146	Organic peroxide type B, liquid
3102	146	Organic peroxide type B, solid
3103	146	Organic peroxide type C, liquid
3104	146	Organic peroxide type C, solid
3105	145	Organic peroxide type D, liquid
3106	145	Organic peroxide type D, solid
3107	145	Organic peroxide type E, liquid
3108	145	Organic peroxide type E, solid
3109	145	Organic peroxide type F, liquid
3110	145	Organic peroxide type F, solid
3111	148	Organic peroxide type B, liquid, temperature controlled
3112	148	Organic peroxide type B, solid, temperature controlled
3113	148	Organic peroxide type C, liquid, temperature controlled
3114	148	Organic peroxide type C, solid, temperature controlled
3115	148	Organic peroxide type D, liquid, temperature controlled
3116	148	Organic peroxide type D, solid, temperature controlled
3117	148	Organic peroxide type E, liquid, temperature controlled
3118	148	Organic peroxide type E, solid, temperature controlled

ID No.	Guide No.	Name of Material
3119	148	Organic peroxide type F, liquid, temperature controlled
3120	148	Organic peroxide type F, solid, temperature controlled
3121	144	Oxidizing solid, water-reactive, n.o.s.
3122	142	Poisonous liquid, oxidizing, n.o.s.
3122	142	Toxic liquid, oxidizing, n.o.s.
3123	139	Poisonous liquid, water-reactive, n.o.s.
3123	139	Toxic liquid, water-reactive, n.o.s.
3124	136	Poisonous solid, self-heating, n.o.s.
3124	136	Toxic solid, self-heating, n.o.s.
3125	139	Poisonous solid, water-reactive, n.o.s.
3125	139	Toxic solid, water-reactive, n.o.s.
3126	136	Self-heating solid, corrosive, organic, n.o.s.
3127	135	Self-heating solid, oxidizing, n.o.s.
3128	136	Self-heating solid, poisonous, organic, n.o.s.
3128	136	Self-heating solid, toxic, organic, n.o.s.
3129	138	Water-reactive liquid, corrosive, n.o.s.
3130	139	Water-reactive liquid, poisonous, n.o.s.
3130	139	Water-reactive liquid, toxic, n.o.s.
3131	138	Water-reactive solid, corrosive, n.o.s.
3132	138	Water-reactive solid, flammable, n.o.s.

ID No.	Guide No.	Name of Material
3133	138	Water-reactive solid, oxidizing, n.o.s.
3134	139	Water-reactive solid, poisonous, n.o.s.
3134	139	Water-reactive solid, toxic, n.o.s.
3135	138	Water-reactive solid, self-heating, n.o.s.
3136	120	Trifluoromethane, refrigerated liquid
3137	140	Oxidizing solid, flammable, n.o.s.
3138	115	Ethylene, acetylene and propylene mixture, refrigerated liquid containing at least 71.5% ethylene with not more than 22.5% acetylene and not more than 6% propylene
3139	140	Oxidizing liquid, n.o.s.
3140	151	Alkaloids, liquid, n.o.s. (poisonous)
3140	151	Alkaloid salts, liquid, n.o.s. (poisonous)
3141	157	Antimony compound, inorganic, liquid, n.o.s.
3142	151	Disinfectant, liquid, poisonous, n.o.s.
3142	151	Disinfectant, liquid, toxic, n.o.s.
3143	151	Dye, solid, poisonous, n.o.s.
3143	151	Dye, solid, toxic, n.o.s.
3143	151	Dye intermediate, solid, poisonous, n.o.s.
3143	151	Dye intermediate, solid, toxic, n.o.s.
3144	151	Nicotine compound, liquid, n.o.s.
3144	151	Nicotine preparation, liquid, n.o.s.

ID No.	Guide No.	Name of Material
3145	153	Alkylphenols, liquid, n.o.s. (including C2-C12 homologues)
3146	153	Organotin compound, solid, n.o.s.
3147	154	Dye, solid, corrosive, n.o.s.
3147	154	Dye intermediate, solid, corrosive, n.o.s.
3148	138	Water-reactive liquid, n.o.s.
3149	140	Hydrogen peroxide and peroxyacetic acid mixture, with acid(s), water and not more than 5% peroxyacetic acid, stabilized
3150	115	Devices, small, hydrocarbon gas powered, with release device
3150	115	Hydrocarbon gas refills for small devices, with release device
3151	171	Halogenated monomethyldiphenylmethanes, liquid
3151	171	Polyhalogenated biphenyls, liquid
3151	171	Polyhalogenated terphenyls, liquid
3152	171	Halogenated monomethyldiphenylmethanes, solid
3152	171	Polyhalogenated biphenyls, solid
3152	171	Polyhalogenated terphenyls, solid
3153	115	Perfluoro(methyl vinyl ether)
3154	115	Perfluoro(ethyl vinyl ether)
3155	154	Pentachlorophenol
3156	122	Compressed gas, oxidizing, n.o.s.
3157	122	Liquefied gas, oxidizing, n.o.s.
3158	120	Gas, refrigerated liquid, n.o.s.

ID No.	Guide No.	Name of Material
3159	126	Refrigerant gas R-134a
3159	126	1,1,1,2-Tetrafluoroethane
3160	119	Liquefied gas, poisonous, flammable, n.o.s.
3160	119	Liquefied gas, poisonous, flammable, n.o.s. (Inhalation Hazard Zone A)
3160	119	Liquefied gas, poisonous, flammable, n.o.s. (Inhalation Hazard Zone B)
3160	119	Liquefied gas, poisonous, flammable, n.o.s. (Inhalation Hazard Zone C)
3160	119	Liquefied gas, poisonous, flammable, n.o.s. (Inhalation Hazard Zone D)
3160	119	Liquefied gas, toxic, flammable, n.o.s.
3160	119	Liquefied gas, toxic, flammable, n.o.s. (Inhalation Hazard Zone A)
3160	119	Liquefied gas, toxic, flammable, n.o.s. (Inhalation Hazard Zone B)
3160	119	Liquefied gas, toxic, flammable, n.o.s. (Inhalation Hazard Zone C)
3160	119	Liquefied gas, toxic, flammable, n.o.s. (Inhalation Hazard Zone D)
3161	115	Liquefied gas, flammable, n.o.s.
3162	123	Liquefied gas, poisonous, n.o.s.
3162	123	Liquefied gas, poisonous, n.o.s. (Inhalation Hazard Zone A)
3162	123	Liquefied gas, poisonous, n.o.s. (Inhalation Hazard Zone B)
3162	123	Liquefied gas, poisonous, n.o.s. (Inhalation Hazard Zone C)
3162	123	Liquefied gas, poisonous, n.o.s. (Inhalation Hazard Zone D)
3162	123	Liquefied gas, toxic, n.o.s.

ID No.	Guide No.	Name of Material
3162	123	Liquefied gas, toxic, n.o.s. (Inhalation Hazard Zone A)
3162	123	Liquefied gas, toxic, n.o.s. (Inhalation Hazard Zone B)
3162	123	Liquefied gas, toxic, n.o.s. (Inhalation Hazard Zone C)
3162	123	Liquefied gas, toxic, n.o.s. (Inhalation Hazard Zone D)
3163	126	Liquefied gas, n.o.s.
3164	126	Articles, pressurized, hydraulic (containing non-flammable gas)
3164	126	Articles, pressurized, pneumatic (containing non-flammable gas)
3165	131	Aircraft hydraulic power unit fuel tank
3166	115	Vehicle, flammable gas powered
3166	128	Vehicle, flammable liquid powered
3166	115	Vehicle, fuel cell, flammable gas powered
3166	128	Vehicle, fuel cell, flammable liquid powered
3167	115	Gas sample, non-pressurized, flammable, n.o.s., not refrigerated liquid
3168	119	Gas sample, non-pressurized, poisonous, flammable, n.o.s., not refrigerated liquid
3168	119	Gas sample, non-pressurized, toxic, flammable, n.o.s., not refrigerated liquid
3169	123	Gas sample, non-pressurized, poisonous, n.o.s., not refrigerated liquid
3169	123	Gas sample, non-pressurized, toxic, n.o.s., not refrigerated liquid
3170	138	Aluminum dross
3170	138	Aluminum remelting by-products

ID No.	Guide No.	Name of Material
3170	138	Aluminum smelting by-products
3171	154	Battery-powered equipment (wet battery)
3171	147	Battery-powered equipment (with lithium ion batteries)
3171	138	Battery-powered equipment (with lithium metal batteries)
3171	138	Battery-powered equipment (with sodium batteries)
3171	154	Battery-powered vehicle (wet battery)
3171	147	Battery-powered vehicle (with lithium ion batteries)
3171	138	Battery-powered vehicle (with sodium batteries)
3171	154	Wheelchair, electric, with batteries
3172	152	Toxins, extracted from living sources, liquid, n.o.s.
3174	135	Titanium disulfide
3174	135	Titanium disulphide
3175	133	Solids containing flammable liquid, n.o.s.
3176	133	Flammable solid, organic, molten, n.o.s.
3178	133	Flammable solid, inorganic, n.o.s.
3178	133	Smokeless powder for small arms
3179	134	Flammable solid, poisonous, inorganic, n.o.s.
3179	134	Flammable solid, toxic, inorganic, n.o.s.
3180	134	Flammable solid, corrosive, inorganic, n.o.s.
3181	133	Metal salts of organic compounds, flammable, n.o.s.

ID No.	Guide No.	Name of Material
3182	170	Metal hydrides, flammable, n.o.s.
3183	135	Self-heating liquid, organic, n.o.s.
3184	136	Self-heating liquid, poisonous, organic, n.o.s.
3184	136	Self-heating liquid, toxic, organic, n.o.s.
3185	136	Self-heating liquid, corrosive, organic, n.o.s.
3186	135	Self-heating liquid, inorganic, n.o.s.
3187	136	Self-heating liquid, poisonous, inorganic, n.o.s.
3187	136	Self-heating liquid, toxic, inorganic, n.o.s.
3188	136	Self-heating liquid, corrosive, inorganic, n.o.s.
3189	135	Metal powder, self-heating, n.o.s.
3190	135	Self-heating solid, inorganic, n.o.s.
3191	136	Self-heating solid, poisonous, inorganic, n.o.s.
3191	136	Self-heating solid, toxic, inorganic, n.o.s.
3192	136	Self-heating solid, corrosive, inorganic, n.o.s.
3194	135	Pyrophoric liquid, inorganic, n.o.s.
3200	135	Pyrophoric solid, inorganic, n.o.s.
3205	135	Alkaline earth metal alcoholates, n.o.s.
3206	136	Alkali metal alcoholates, self-heating, corrosive, n.o.s.
3208	138	Metallic substance, water-reactive, n.o.s.
3209	138	Metallic substance, water-reactive, self-heating, n.o.s.

ID No.	Guide No.	Name of Material
3210	140	Chlorates, inorganic, aqueous solution, n.o.s.
3211	140	Perchlorates, inorganic, aqueous solution, n.o.s.
3212	140	Hypochlorites, inorganic, n.o.s.
3213	140	Bromates, inorganic, aqueous solution, n.o.s.
3214	140	Permanganates, inorganic, aqueous solution, n.o.s.
3215	140	Persulfates, inorganic, n.o.s.
3215	140	Persulphates, inorganic, n.o.s.
3216	140	Persulfates, inorganic, aqueous solution, n.o.s.
3216	140	Persulphates, inorganic, aqueous solution, n.o.s.
3218	140	Nitrates, inorganic, aqueous solution, n.o.s.
3219	140	Nitrites, inorganic, aqueous solution, n.o.s.
3220	126	Pentafluoroethane
3220	126	Refrigerant gas R-125
3221	149	Self-reactive liquid type B
3222	149	Self-reactive solid type B
3223	149	Self-reactive liquid type C
3224	149	Self-reactive solid type C
3225	149	Self-reactive liquid type D
3226	149	Self-reactive solid type D
3227	149	Self-reactive liquid type E
3228	149	Self-reactive solid type E
3229	149	Self-reactive liquid type F
3230	149	Self-reactive solid type F
3231	150	Self-reactive liquid type B, temperature controlled
3232	150	Self-reactive solid type B, temperature controlled

ID No.	Guide No.	Name of Material
3233	150	Self-reactive liquid type C, temperature controlled
3234	150	Self-reactive solid type C, temperature controlled
3235	150	Self-reactive liquid type D, temperature controlled
3236	150	Self-reactive solid type D, temperature controlled
3237	150	Self-reactive liquid type E, temperature controlled
3238	150	Self-reactive solid type E, temperature controlled
3239	150	Self-reactive liquid type F, temperature controlled
3240	150	Self-reactive solid type F, temperature controlled
3241	133	2-Bromo-2-nitropropane-1, 3-diol
3242	149	Azodicarbonamide
3243	151	Solids containing poisonous liquid, n.o.s.
3243	151	Solids containing toxic liquid, n.o.s.
3244	154	Solids containing corrosive liquid, n.o.s.
3245	171	Genetically modified micro-organisms
3245	171	Genetically modified organisms
3246	156	Methanesulfonyl chloride
3246	156	Methanesulphonyl chloride
3247	140	Sodium peroxoborate, anhydrous
3248	131	Medicine, liquid, flammable, poisonous, n.o.s.
3248	131	Medicine, liquid, flammable, toxic, n.o.s.
3249	151	Medicine, solid, poisonous, n.o.s.
3249	151	Medicine, solid, toxic, n.o.s.

ID No.	Guide No.	Name of Material
3250	153	Chloroacetic acid, molten
3251	133	Isosorbide-5-mononitrate
3252	115	Difluoromethane
3252	115	Refrigerant gas R-32
3253	154	Disodium trioxosilicate
3254	135	Tributylphosphane
3255	135	tert-Butyl hypochlorite
3256	128	Elevated temperature liquid, flammable, n.o.s., with flash point above 37.8°C (100°F), at or above its flash point
3256	128	Elevated temperature liquid, flammable, n.o.s., with flash point above 60°C (140°F), at or above its flash point
3257	171	Elevated temperature liquid, n.o.s., at or above 100°C (212°F), and below its flash point
3258	171	Elevated temperature solid, n.o.s., at or above 240°C (464°F)
3259	154	Amines, solid, corrosive, n.o.s.
3259	154	Polyamines, solid, corrosive, n.o.s.
3260	154	Corrosive solid, acidic, inorganic, n.o.s.
3261	154	Corrosive solid, acidic, organic, n.o.s.
3262	154	Corrosive solid, basic, inorganic, n.o.s.
3263	154	Corrosive solid, basic, organic, n.o.s.
3264	154	Corrosive liquid, acidic, inorganic, n.o.s.
3265	153	Corrosive liquid, acidic, organic, n.o.s.
3266	154	Corrosive liquid, basic, inorganic, n.o.s.

ID No.	Guide No.	Name of Material
3267	153	Corrosive liquid, basic, organic, n.o.s.
3268	171	Air bag inflators
3268	171	Air bag modules
3268	171	Safety devices
3268	171	Seat-belt pre-tensioners
3269	128	Polyester resin kit, liquid base material
3270	133	Nitrocellulose membrane filters
3271	127	Ethers, n.o.s.
3272	127	Esters, n.o.s.
3273	131	Nitriles, flammable, poisonous, n.o.s.
3273	131	Nitriles, flammable, toxic, n.o.s.
3274	132	Alcoholates solution, n.o.s., in alcohol
3275	131	Nitriles, poisonous, flammable, n.o.s.
3275	131	Nitriles, toxic, flammable, n.o.s.
3276	151	Nitriles, liquid, poisonous, n.o.s.
3276	151	Nitriles, liquid, toxic, n.o.s.
3276	151	Nitriles, poisonous, liquid, n.o.s.
3276	151	Nitriles, toxic, liquid, n.o.s.
3277	154	Chloroformates, poisonous, corrosive, n.o.s.
3277	154	Chloroformates, toxic, corrosive, n.o.s.
3278	151	Organophosphorus compound, liquid, poisonous, n.o.s.
3278	151	Organophosphorus compound, liquid, toxic, n.o.s.
3279	131	Organophosphorus compound, poisonous, flammable, n.o.s.
3279	131	Organophosphorus compound, toxic, flammable, n.o.s.

ID No.	Guide No.	Name of Material
3280	151	Organoarsenic compound, liquid, n.o.s.
3281	151	Metal carbonyls, liquid, n.o.s.
3282	151	Organometallic compound, liquid, poisonous, n.o.s.
3282	151	Organometallic compound, liquid, toxic, n.o.s.
3283	151	Selenium compound, solid, n.o.s.
3284	151	Tellurium compound, n.o.s.
3285	151	Vanadium compound, n.o.s.
3286	131	Flammable liquid, poisonous, corrosive, n.o.s.
3286	131	Flammable liquid, toxic, corrosive, n.o.s.
3287	151	Poisonous liquid, inorganic, n.o.s.
3287	151	Toxic liquid, inorganic, n.o.s.
3288	151	Poisonous solid, inorganic, n.o.s.
3288	151	Toxic solid, inorganic, n.o.s.
3289	154	Poisonous liquid, corrosive, inorganic, n.o.s.
3289	154	Toxic liquid, corrosive, inorganic, n.o.s.
3290	154	Poisonous solid, corrosive, inorganic, n.o.s.
3290	154	Toxic solid, corrosive, inorganic, n.o.s.
3291	158	(Bio)Medical waste, n.o.s.
3291	158	Clinical waste, unspecified, n.o.s.
3291	158	Medical waste, n.o.s.
3291	158	Regulated medical waste, n.o.s.
3292	138	Batteries, containing metallic sodium or sodium alloy
3292	138	Batteries, containing sodium

ID No.	Guide No.	Name of Material
3292	138	Cells, containing metallic sodium or sodium alloy
3292	138	Cells, containing sodium
3293	153	Hydrazine, aqueous solution, with not more than 37% hydrazine
3294	131	Hydrogen cyanide, solution in alcohol, with not more than 45% hydrogen cyanide
3295	128	Hydrocarbons, liquid, n.o.s.
3296	126	Heptafluoropropane
3296	126	Refrigerant gas R-227
3297	126	Ethylene oxide and chlorotetrafluoroethane mixture, with not more than 8.8% ethylene oxide
3298	126	Ethylene oxide and pentafluoroethane mixture, with not more than 7.9% ethylene oxide
3299	126	Ethylene oxide and tetrafluoroethane mixture, with not more than 5.6% ethylene oxide
3300	119P	Ethylene oxide and carbon dioxide mixture, with more than 87% ethylene oxide
3301	136	Corrosive liquid, self-heating, n.o.s.
3302	152P	2-Dimethylaminoethyl acrylate, stabilized
3303	124	Compressed gas, poisonous, oxidizing, n.o.s.
3303	124	Compressed gas, poisonous, oxidizing, n.o.s. (Inhalation Hazard Zone A)
3303	124	Compressed gas, poisonous, oxidizing, n.o.s. (Inhalation Hazard Zone B)
3303	124	Compressed gas, poisonous, oxidizing, n.o.s. (Inhalation Hazard Zone C)

ID No.	Guide No.	Name of Material
3303	124	Compressed gas, poisonous, oxidizing, n.o.s. (Inhalation Hazard Zone D)
3303	124	Compressed gas, toxic, oxidizing, n.o.s.
3303	124	Compressed gas, toxic, oxidizing, n.o.s. (Inhalation Hazard Zone A)
3303	124	Compressed gas, toxic, oxidizing, n.o.s. (Inhalation Hazard Zone B)
3303	124	Compressed gas, toxic, oxidizing, n.o.s. (Inhalation Hazard Zone C)
3303	124	Compressed gas, toxic, oxidizing, n.o.s. (Inhalation Hazard Zone D)
3304	125	Compressed gas, poisonous, corrosive, n.o.s.
3304	125	Compressed gas, poisonous, corrosive, n.o.s. (Inhalation Hazard Zone A)
3304	125	Compressed gas, poisonous, corrosive, n.o.s. (Inhalation Hazard Zone B)
3304	125	Compressed gas, poisonous, corrosive, n.o.s. (Inhalation Hazard Zone C)
3304	125	Compressed gas, poisonous, corrosive, n.o.s. (Inhalation Hazard Zone D)
3304	125	Compressed gas, toxic, corrosive, n.o.s.
3304	125	Compressed gas, toxic, corrosive, n.o.s. (Inhalation Hazard Zone A)
3304	125	Compressed gas, toxic, corrosive, n.o.s. (Inhalation Hazard Zone B)
3304	125	Compressed gas, toxic, corrosive, n.o.s. (Inhalation Hazard Zone C)

ID Guide
No. No.

Name of Material

ID Guide
No. No.

Name of Material

3304 125 Compressed gas, toxic,
corrosive, n.o.s. (Inhalation
Hazard Zone D)

3305 119 Compressed gas, poisonous,
flammable, corrosive, n.o.s.

3305 119 Compressed gas, poisonous,
flammable, corrosive, n.o.s.
(Inhalation Hazard Zone A)

3305 119 Compressed gas, poisonous,
flammable, corrosive, n.o.s.
(Inhalation Hazard Zone B)

3305 119 Compressed gas, poisonous,
flammable, corrosive, n.o.s.
(Inhalation Hazard Zone C)

3305 119 Compressed gas, poisonous,
flammable, corrosive, n.o.s.
(Inhalation Hazard Zone D)

3305 119 Compressed gas, toxic,
flammable, corrosive, n.o.s.

3305 119 Compressed gas, toxic,
flammable, corrosive, n.o.s.
(Inhalation Hazard Zone A)

3305 119 Compressed gas, toxic,
flammable, corrosive, n.o.s.
(Inhalation Hazard Zone B)

3305 119 Compressed gas, toxic,
flammable, corrosive, n.o.s.
(Inhalation Hazard Zone C)

3305 119 Compressed gas, toxic,
flammable, corrosive, n.o.s.
(Inhalation Hazard Zone D)

3306 124 Compressed gas, poisonous,
oxidizing, corrosive, n.o.s.

3306 124 Compressed gas, poisonous,
oxidizing, corrosive, n.o.s.
(Inhalation Hazard Zone A)

3306 124 Compressed gas, poisonous,
oxidizing, corrosive, n.o.s.
(Inhalation Hazard Zone B)

3306 124 Compressed gas, poisonous,
oxidizing, corrosive, n.o.s.
(Inhalation Hazard Zone C)

3306 124 Compressed gas, poisonous,
oxidizing, corrosive, n.o.s.
(Inhalation Hazard Zone D)

3306 124 Compressed gas, toxic,
oxidizing, corrosive, n.o.s.

3306 124 Compressed gas, toxic,
oxidizing, corrosive, n.o.s.
(Inhalation Hazard Zone A)

3306 124 Compressed gas, toxic,
oxidizing, corrosive, n.o.s.
(Inhalation Hazard Zone B)

3306 124 Compressed gas, toxic,
oxidizing, corrosive, n.o.s.
(Inhalation Hazard Zone C)

3306 124 Compressed gas, toxic,
oxidizing, corrosive, n.o.s.
(Inhalation Hazard Zone D)

3307 124 Liquefied gas, poisonous,
oxidizing, n.o.s.

3307 124 Liquefied gas, poisonous,
oxidizing, n.o.s. (Inhalation
Hazard Zone A)

3307 124 Liquefied gas, poisonous,
oxidizing, n.o.s. (Inhalation
Hazard Zone B)

3307 124 Liquefied gas, poisonous,
oxidizing, n.o.s. (Inhalation
Hazard Zone C)

3307 124 Liquefied gas, poisonous,
oxidizing, n.o.s. (Inhalation
Hazard Zone D)

3307 124 Liquefied gas, toxic, oxidizing,
n.o.s.

3307 124 Liquefied gas, toxic, oxidizing,
n.o.s. (Inhalation Hazard
Zone A)

3307 124 Liquefied gas, toxic, oxidizing,
n.o.s. (Inhalation Hazard
Zone B)

3307 124 Liquefied gas, toxic, oxidizing,
n.o.s. (Inhalation Hazard
Zone C)

ID No.	Guide No.	Name of Material
3307	124	Liquefied gas, toxic, oxidizing, n.o.s. (Inhalation Hazard Zone D)
3308	125	Liquefied gas, poisonous, corrosive, n.o.s.
3308	125	Liquefied gas, poisonous, corrosive, n.o.s. (Inhalation Hazard Zone A)
3308	125	Liquefied gas, poisonous, corrosive, n.o.s. (Inhalation Hazard Zone B)
3308	125	Liquefied gas, poisonous, corrosive, n.o.s. (Inhalation Hazard Zone C)
3308	125	Liquefied gas, poisonous, corrosive, n.o.s. (Inhalation Hazard Zone D)
3308	125	Liquefied gas, toxic, corrosive, n.o.s.
3308	125	Liquefied gas, toxic, corrosive, n.o.s. (Inhalation Hazard Zone A)
3308	125	Liquefied gas, toxic, corrosive, n.o.s. (Inhalation Hazard Zone B)
3308	125	Liquefied gas, toxic, corrosive, n.o.s. (Inhalation Hazard Zone C)
3308	125	Liquefied gas, toxic, corrosive, n.o.s. (Inhalation Hazard Zone D)
3309	119	Liquefied gas, poisonous, flammable, corrosive, n.o.s.
3309	119	Liquefied gas, poisonous, flammable, corrosive, n.o.s. (Inhalation Hazard Zone A)
3309	119	Liquefied gas, poisonous, flammable, corrosive, n.o.s. (Inhalation Hazard Zone B)
3309	119	Liquefied gas, poisonous, flammable, corrosive, n.o.s. (Inhalation Hazard Zone C)

ID No.	Guide No.	Name of Material
3309	119	Liquefied gas, poisonous, flammable, corrosive, n.o.s. (Inhalation Hazard Zone D)
3309	119	Liquefied gas, toxic, flammable, corrosive, n.o.s.
3309	119	Liquefied gas, toxic, flammable, corrosive, n.o.s. (Inhalation Hazard Zone A)
3309	119	Liquefied gas, toxic, flammable, corrosive, n.o.s. (Inhalation Hazard Zone B)
3309	119	Liquefied gas, toxic, flammable, corrosive, n.o.s. (Inhalation Hazard Zone C)
3309	119	Liquefied gas, toxic, flammable, corrosive, n.o.s. (Inhalation Hazard Zone D)
3310	124	Liquefied gas, poisonous, oxidizing, corrosive, n.o.s.
3310	124	Liquefied gas, poisonous, oxidizing, corrosive, n.o.s. (Inhalation Hazard Zone A)
3310	124	Liquefied gas, poisonous, oxidizing, corrosive, n.o.s. (Inhalation Hazard Zone B)
3310	124	Liquefied gas, poisonous, oxidizing, corrosive, n.o.s. (Inhalation Hazard Zone C)
3310	124	Liquefied gas, poisonous, oxidizing, corrosive, n.o.s. (Inhalation Hazard Zone D)
3310	124	Liquefied gas, toxic, oxidizing, corrosive, n.o.s.
3310	124	Liquefied gas, toxic, oxidizing, corrosive, n.o.s. (Inhalation Hazard Zone A)
3310	124	Liquefied gas, toxic, oxidizing, corrosive, n.o.s. (Inhalation Hazard Zone B)
3310	124	Liquefied gas, toxic, oxidizing, corrosive, n.o.s. (Inhalation Hazard Zone C)

ID Guide
No. No.

Name of Material

ID Guide
No. No.

Name of Material

3310	124	Liquefied gas, toxic, oxidizing, corrosive, n.o.s. (Inhalation Hazard Zone D)
3311	122	Gas, refrigerated liquid, oxidizing, n.o.s.
3312	115	Gas, refrigerated liquid, flammable, n.o.s.
3313	135	Organic pigments, self-heating
3314	171	Plastic molding compound
3314	171	Plastics moulding compound
3315	151	Chemical sample, poisonous
3315	151	Chemical sample, toxic
3316	171	Chemical kit
3316	171	First aid kit
3317	113	2-Amino-4,6-dinitrophenol, wetted with not less than 20% water
3318	125	Ammonia solution, with more than 50% ammonia
3319	113	Nitroglycerin mixture, desensitized, solid, n.o.s., with more than 2% but not more than 10% nitroglycerin
3320	157	Sodium borohydride and sodium hydroxide solution, with not more than 12% sodium borohydride and not more than 40% sodium hydroxide
3321	162	Radioactive material, low specific activity (LSA-II), non fissile or fissile-excepted
3322	162	Radioactive material, low specific activity (LSA-III), non fissile or fissile-excepted
3323	163	Radioactive material, Type C package, non fissile or fissile excepted
3324	165	Radioactive material, low specific activity (LSA-II), fissile

3325	165	Radioactive material, low specific activity (LSA-III), fissile
3326	165	Radioactive material, surface contaminated objects (SCO-I or SCO-II), fissile
3327	165	Radioactive material, Type A package, fissile, non-special form
3328	165	Radioactive material, Type B(U) package, fissile
3329	165	Radioactive material, Type B(M) package, fissile
3330	165	Radioactive material, Type C package, fissile
3331	165	Radioactive material, transported under special arrangement, fissile
3332	164	Radioactive material, Type A package, special form, non fissile or fissile-excepted
3333	165	Radioactive material, Type A package, special form, fissile
3334	171	Aviation regulated liquid, n.o.s.
3334	171	Self-defense spray, non-pressurized
3335	171	Aviation regulated solid, n.o.s.
3336	130	Mercaptan mixture, liquid, flammable, n.o.s.
3336	130	Mercaptans, liquid, flammable, n.o.s.
3337	126	Refrigerant gas R-404A
3338	126	Refrigerant gas R-407A
3339	126	Refrigerant gas R-407B
3340	126	Refrigerant gas R-407C
3341	135	Thiourea dioxide
3342	135	Xanthates

ID No.	Guide No.	Name of Material
3343	113	Nitroglycerin mixture, desensitized, liquid, flammable, n.o.s., with not more than 30% nitroglycerin
3344	113	Pentaerythrite tetranitrate mixture, desensitized, solid, n.o.s., with more than 10% but not more than 20% PETN
3344	113	Pentaerythritol tetranitrate mixture, desensitized, solid, n.o.s., with more than 10% but not more than 20% PETN
3344	113	PETN mixture, desensitized, solid, n.o.s., with more than 10% but not more than 20% PETN
3345	153	Phenoxyacetic acid derivative pesticide, solid, poisonous
3345	153	Phenoxyacetic acid derivative pesticide, solid, toxic
3346	131	Phenoxyacetic acid derivative pesticide, liquid, flammable, poisonous
3346	131	Phenoxyacetic acid derivative pesticide, liquid, flammable, toxic
3347	131	Phenoxyacetic acid derivative pesticide, liquid, poisonous, flammable
3347	131	Phenoxyacetic acid derivative pesticide, liquid, toxic, flammable
3348	153	Phenoxyacetic acid derivative pesticide, liquid, poisonous
3348	153	Phenoxyacetic acid derivative pesticide, liquid, toxic
3349	151	Pyrethroid pesticide, solid, poisonous
3349	151	Pyrethroid pesticide, solid, toxic
3350	131	Pyrethroid pesticide, liquid, flammable, poisonous
3350	131	Pyrethroid pesticide, liquid, flammable, toxic

ID No.	Guide No.	Name of Material
3351	131	Pyrethroid pesticide, liquid, poisonous, flammable
3351	131	Pyrethroid pesticide, liquid, toxic, flammable
3352	151	Pyrethroid pesticide, liquid, poisonous
3352	151	Pyrethroid pesticide, liquid, toxic
3354	115	Insecticide gas, flammable, n.o.s.
3355	119	Insecticide gas, poisonous, flammable, n.o.s.
3355	119	Insecticide gas, poisonous, flammable, n.o.s. (Inhalation Hazard Zone A)
3355	119	Insecticide gas, poisonous, flammable, n.o.s. (Inhalation Hazard Zone B)
3355	119	Insecticide gas, poisonous, flammable, n.o.s. (Inhalation Hazard Zone C)
3355	119	Insecticide gas, poisonous, flammable, n.o.s. (Inhalation Hazard Zone D)
3355	119	Insecticide gas, toxic, flammable, n.o.s.
3355	119	Insecticide gas, toxic, flammable, n.o.s. (Inhalation Hazard Zone A)
3355	119	Insecticide gas, toxic, flammable, n.o.s. (Inhalation Hazard Zone B)
3355	119	Insecticide gas, toxic, flammable, n.o.s. (Inhalation Hazard Zone C)
3355	119	Insecticide gas, toxic, flammable, n.o.s. (Inhalation Hazard Zone D)
3356	140	Oxygen generator, chemical
3356	140	Oxygen generator, chemical, spent

ID No.	Guide No.	Name of Material
3357	113	Nitroglycerin mixture, desensitized, liquid, n.o.s., with not more than 30% nitroglycerin
3358	115	Refrigerating machines, containing flammable, non-poisonous, liquefied gas
3358	115	Refrigerating machines, containing flammable, non-toxic, liquefied gas
3359	171	Fumigated cargo transport unit
3360	133	Fibers, vegetable, dry
3360	133	Fibres, vegetable, dry
3361	156	Chlorosilanes, poisonous, corrosive, n.o.s.
3361	156	Chlorosilanes, toxic, corrosive, n.o.s.
3362	155	Chlorosilanes, poisonous, corrosive, flammable, n.o.s.
3362	155	Chlorosilanes, toxic, corrosive, flammable, n.o.s.
3363	171	Dangerous goods in apparatus
3363	171	Dangerous goods in articles
3363	171	Dangerous goods in machinery
3364	113	Picric acid, wetted with not less than 10% water
3364	113	Trinitrophenol, wetted with not less than 10% water
3365	113	Picryl chloride, wetted with not less than 10% water
3365	113	Trinitrochlorobenzene, wetted with not less than 10% water
3366	113	TNT, wetted with not less than 10% water
3366	113	Trinitrotoluene, wetted with not less than 10% water
3367	113	Trinitrobenzene, wetted with not less than 10% water

ID No.	Guide No.	Name of Material
3368	113	Trinitrobenzoic acid, wetted with not less than 10% water
3369	113	Sodium dinitro-o-cresolate, wetted with not less than 10% water
3370	113	Urea nitrate, wetted with not less than 10% water
3371	129	2-Methylbutanal
3373	158	Biological substance, category B
3374	116	Acetylene, solvent free
3375	140	Ammonium nitrate emulsion
3375	140	Ammonium nitrate gel
3375	140	Ammonium nitrate suspension
3376	113	4-Nitrophenylhydrazine, with not less than 30% water
3377	140	Sodium perborate monohydrate
3378	140	Sodium carbonate peroxyhydrate
3379	113	Desensitized explosive, liquid, n.o.s.
3380	113	Desensitized explosive, solid, n.o.s.
3381	151	Poisonous by inhalation liquid, n.o.s. (Inhalation Hazard Zone A)
3381	151	Toxic by inhalation liquid, n.o.s. (Inhalation Hazard Zone A)
3382	151	Poisonous by inhalation liquid, n.o.s. (Inhalation Hazard Zone B)
3382	151	Toxic by inhalation liquid, n.o.s. (Inhalation Hazard Zone B)
3383	131	Poisonous by inhalation liquid, flammable, n.o.s. (Inhalation Hazard Zone A)
3383	131	Toxic by inhalation liquid, flammable, n.o.s. (Inhalation Hazard Zone A)

ID No.	Guide No.	Name of Material
3384	131	Poisonous by inhalation liquid, flammable, n.o.s. (Inhalation Hazard Zone B)
3384	131	Toxic by inhalation liquid, flammable, n.o.s. (Inhalation Hazard Zone B)
3385	139	Poisonous by inhalation liquid, water-reactive, n.o.s. (Inhalation Hazard Zone A)
3385	139	Toxic by inhalation liquid, water-reactive, n.o.s. (Inhalation Hazard Zone A)
3386	139	Poisonous by inhalation liquid, water-reactive, n.o.s. (Inhalation Hazard Zone B)
3386	139	Toxic by inhalation liquid, water-reactive, n.o.s. (Inhalation Hazard Zone B)
3387	142	Poisonous by inhalation liquid, oxidizing, n.o.s. (Inhalation Hazard Zone A)
3387	142	Toxic by inhalation liquid, oxidizing, n.o.s. (Inhalation Hazard Zone A)
3388	142	Poisonous by inhalation liquid, oxidizing, n.o.s. (Inhalation Hazard Zone B)
3388	142	Toxic by inhalation liquid, oxidizing, n.o.s. (Inhalation Hazard Zone B)
3389	154	Poisonous by inhalation liquid, corrosive, n.o.s. (Inhalation Hazard Zone A)
3389	154	Toxic by inhalation liquid, corrosive, n.o.s. (Inhalation Hazard Zone A)
3390	154	Poisonous by inhalation liquid, corrosive, n.o.s. (Inhalation Hazard Zone B)
3390	154	Toxic by inhalation liquid, corrosive, n.o.s. (Inhalation Hazard Zone B)

ID No.	Guide No.	Name of Material
3391	135	Organometallic substance, solid, pyrophoric
3392	135	Organometallic substance, liquid, pyrophoric
3393	135	Organometallic substance, solid, pyrophoric, water-reactive
3394	135	Organometallic substance, liquid, pyrophoric, water-reactive
3395	135	Organometallic substance, solid, water-reactive
3396	138	Organometallic substance, solid, water-reactive, flammable
3397	138	Organometallic substance, solid, water-reactive, self-heating
3398	135	Organometallic substance, liquid, water-reactive
3399	138	Organometallic substance, liquid, water-reactive, flammable
3400	138	Organometallic substance, solid, self-heating
3401	138	Alkali metal amalgam, solid
3402	138	Alkaline earth metal amalgam, solid
3403	138	Potassium metal alloys, solid
3404	138	Potassium sodium alloys, solid
3405	141	Barium chlorate, solution
3406	141	Barium perchlorate, solution
3407	140	Chlorate and magnesium chloride mixture, solution
3408	141	Lead perchlorate, solution
3409	152	Chloronitrobenzenes, liquid
3410	153	4-Chloro-o-toluidine hydrochloride, solution
3411	153	beta-Naphthylamine, solution

ID No.	Guide No.	Name of Material
3411	153	Naphthylamine (beta), solution
3412	153	Formic acid, with not less than 5% but less than 10% acid
3412	153	Formic acid, with not less than 10% but not more than 85% acid
3413	157	Potassium cyanide, solution
3414	157	Sodium cyanide, solution
3415	154	Sodium fluoride, solution
3416	153	Chloroacetophenone, liquid
3417	152	Xylyl bromide, solid
3418	151	2,4-Toluediamine, solution
3418	151	2,4-Toluylenediamine, solution
3419	157	Boron trifluoride acetic acid complex, solid
3420	157	Boron trifluoride propionic acid complex, solid
3421	154	Potassium hydrogen difluoride, solution
3422	154	Potassium fluoride, solution
3423	153	Tetramethylammonium hydroxide, solid
3424	141	Ammonium dinitro-o-cresolate, solution
3425	156	Bromoacetic acid, solid
3426	153P	Acrylamide, solution
3427	153	Chlorobenzyl chlorides, solid
3428	156	3-Chloro-4-methylphenyl isocyanate, solid
3429	153	Chlorotoluidines, liquid
3430	153	Xylenols, liquid
3431	152	Nitrobenzotrifluorides, solid
3432	171	PCB, solid
3432	171	Polychlorinated biphenyls, solid
3434	153	Nitrocresols, liquid

ID No.	Guide No.	Name of Material
3436	151	Hexafluoroacetone hydrate, solid
3437	152	Chlorocresols, solid
3438	153	alpha-Methylbenzyl alcohol, solid
3438	153	Methylbenzyl (alpha) alcohol, solid
3439	151	Nitriles, solid, poisonous, n.o.s.
3439	151	Nitriles, solid, toxic, n.o.s.
3440	151	Selenium compound, liquid, n.o.s.
3441	153	Chlorodinitrobenzenes, solid
3442	153	Dichloroanilines, solid
3443	152	Dinitrobenzenes, solid
3444	151	Nicotine hydrochloride, solid
3445	151	Nicotine sulfate, solid
3445	151	Nicotine sulphate, solid
3446	152	Nitrotoluenes, solid
3447	152	Nitroxylenes, solid
3448	159	Tear gas substance, solid, n.o.s.
3449	159	Bromobenzyl cyanides, solid
3450	151	Diphenylchloroarsine, solid
3451	153	Toluidines, solid
3452	153	Xylidines, solid
3453	154	Phosphoric acid, solid
3454	152	Dinitrotoluenes, solid
3455	153	Cresols, solid
3456	157	Nitrosylsulfuric acid, solid
3456	157	Nitrosylsulphuric acid, solid
3457	152	Chloronitrotoluenes, solid
3458	152	Nitroanisoles, solid
3459	152	Nitrobromobenzenes, solid
3460	153	N-Ethylbenzyltoluidines, solid

ID No.	Guide No.	Name of Material
3462	152	Toxins, extracted from living sources, solid, n.o.s.
3463	153	Propionic acid, with not less than 90% acid
3464	151	Organophosphorus compound, solid, poisonous, n.o.s.
3464	151	Organophosphorus compound, solid, toxic, n.o.s.
3465	151	Organoarsenic compound, solid, n.o.s.
3466	151	Metal carbonyls, solid, n.o.s.
3467	151	Organometallic compound, solid, poisonous, n.o.s.
3467	151	Organometallic compound, solid, toxic, n.o.s.
3468	115	Hydrogen in a metal hydride storage system
3468	115	Hydrogen in a metal hydride storage system contained in equipment
3468	115	Hydrogen in a metal hydride storage system packed with equipment
3469	132	Paint, flammable, corrosive
3469	132	Paint related material, flammable, corrosive
3470	132	Paint, corrosive, flammable
3470	132	Paint related material, corrosive, flammable
3471	154	Hydrogendifluorides, solution, n.o.s.
3472	153	Crotonic acid, liquid
3473	128	Fuel cell cartridges, containing flammable liquids
3473	128	Fuel cell cartridges contained in equipment, containing flammable liquids
3473	128	Fuel cell cartridges packed with equipment, containing flammable liquids

ID No.	Guide No.	Name of Material
3474	113	1-Hydroxybenzotriazole, monohydrate
3475	127	Ethanol and gasoline mixture, with more than 10% ethanol
3475	127	Ethanol and motor spirit mixture, with more than 10% ethanol
3475	127	Ethanol and petrol mixture, with more than 10% ethanol
3476	138	Fuel cell cartridges, containing water-reactive substances
3476	138	Fuel cell cartridges contained in equipment, containing water-reactive substances
3476	138	Fuel cell cartridges packed with equipment, containing water-reactive substances
3477	153	Fuel cell cartridges, containing corrosive substances
3477	153	Fuel cell cartridges contained in equipment, containing corrosive substances
3477	153	Fuel cell cartridges packed with equipment, containing corrosive substances
3478	115	Fuel cell cartridges, containing liquefied flammable gas
3478	115	Fuel cell cartridges contained in equipment, containing liquefied flammable gas
3478	115	Fuel cell cartridges packed with equipment, containing liquefied flammable gas
3479	115	Fuel cell cartridges, containing hydrogen in metal hydride
3479	115	Fuel cell cartridges contained in equipment, containing hydrogen in metal hydride
3479	115	Fuel cell cartridges packed with equipment, containing hydrogen in metal hydride

ID No.	Guide No.	Name of Material
3480	147	Lithium ion batteries (including lithium ion polymer batteries)
3481	147	Lithium ion batteries contained in equipment (including lithium ion polymer batteries)
3481	147	Lithium ion batteries packed with equipment (including lithium ion polymer batteries)
3482	138	Alkali metal dispersion, flammable
3482	138	Alkaline earth metal dispersion, flammable
3483	131	Motor fuel anti-knock mixture, flammable
3484	132	Hydrazine aqueous solution, flammable, with more than 37% hydrazine
3485	140	Calcium hypochlorite, dry, corrosive, with more than 39% available chlorine (8.8% available oxygen)
3485	140	Calcium hypochlorite mixture, dry, corrosive, with more than 39% available chlorine (8.8% available oxygen)
3486	140	Calcium hypochlorite mixture, dry, corrosive, with more than 10% but not more than 39% available chlorine
3487	140	Calcium hypochlorite, hydrated, corrosive, with not less than 5.5% but not more than 16% water
3487	140	Calcium hypochlorite, hydrated mixture, corrosive, with not less than 5.5% but not more than 16% water
3488	131	Poisonous by inhalation liquid, flammable, corrosive, n.o.s. (Inhalation Hazard Zone A)
3488	131	Toxic by inhalation liquid, flammable, corrosive, n.o.s. (Inhalation Hazard Zone A)

ID No.	Guide No.	Name of Material
3489	131	Poisonous by inhalation liquid, flammable, corrosive, n.o.s. (Inhalation Hazard Zone B)
3489	131	Toxic by inhalation liquid, flammable, corrosive, n.o.s. (Inhalation Hazard Zone B)
3490	155	Poisonous by inhalation liquid, water-reactive, flammable, n.o.s. (Inhalation Hazard Zone A)
3490	155	Toxic by inhalation liquid, water-reactive, flammable, n.o.s. (Inhalation Hazard Zone A)
3491	155	Poisonous by inhalation liquid, water-reactive, flammable, n.o.s. (Inhalation Hazard Zone B)
3491	155	Toxic by inhalation liquid, water-reactive, flammable, n.o.s. (Inhalation Hazard Zone B)
3492	131	Poisonous by inhalation liquid, corrosive, flammable, n.o.s. (Inhalation Hazard Zone A)
3492	131	Toxic by inhalation liquid, corrosive, flammable, n.o.s. (Inhalation Hazard Zone A)
3493	131	Poisonous by inhalation liquid, corrosive, flammable, n.o.s. (Inhalation Hazard Zone B)
3493	131	Toxic by inhalation liquid, corrosive, flammable, n.o.s. (Inhalation Hazard Zone B)
3494	131	Petroleum sour crude oil, flammable, poisonous
3494	131	Petroleum sour crude oil, flammable, toxic
3495	154	Iodine
3496	171	Batteries, nickel-metal hydride
3497	133	Krill meal
3498	157	Iodine monochloride, liquid
3499	171	Capacitor, electric double layer

ID No.	Guide No.	Name of Material
3500	126	Chemical under pressure, n.o.s.
3501	115	Chemical under pressure, flammable, n.o.s.
3502	123	Chemical under pressure, poisonous, n.o.s.
3502	123	Chemical under pressure, toxic, n.o.s.
3503	125	Chemical under pressure, corrosive, n.o.s.
3504	119	Chemical under pressure, flammable, poisonous, n.o.s.
3504	119	Chemical under pressure, flammable, toxic, n.o.s.
3505	118	Chemical under pressure, flammable, corrosive, n.o.s.
3506	172	Mercury contained in manufactured articles
3507	166	Uranium hexafluoride, radioactive material, excepted package, less than 0.1 kg per package, non-fissile or fissile-excepted
3508	171	Capacitor, asymmetric
3509	171	Packagings discarded, empty, uncleaned
3510	174	Adsorbed gas, flammable, n.o.s.
3511	174	Adsorbed gas, n.o.s.
3512	173	Adsorbed gas, poisonous, n.o.s.
3512	173	Adsorbed gas, poisonous, n.o.s. (Inhalation Hazard Zone A)
3512	173	Adsorbed gas, poisonous, n.o.s. (Inhalation Hazard Zone B)
3512	173	Adsorbed gas, poisonous, n.o.s. (Inhalation Hazard Zone C)
3512	173	Adsorbed gas, poisonous, n.o.s. (Inhalation Hazard Zone D)
3512	173	Adsorbed gas, toxic, n.o.s.
3512	173	Adsorbed gas, toxic, n.o.s. (Inhalation Hazard Zone A)

ID No.	Guide No.	Name of Material
3512	173	Adsorbed gas, toxic, n.o.s. (Inhalation Hazard Zone B)
3512	173	Adsorbed gas, toxic, n.o.s. (Inhalation Hazard Zone C)
3512	173	Adsorbed gas, toxic, n.o.s. (Inhalation Hazard Zone D)
3513	174	Adsorbed gas, oxidizing, n.o.s.
3514	173	Adsorbed gas, poisonous, flammable, n.o.s.
3514	173	Adsorbed gas, poisonous, flammable, n.o.s. (Inhalation Hazard Zone A)
3514	173	Adsorbed gas, poisonous, flammable, n.o.s. (Inhalation Hazard Zone B)
3514	173	Adsorbed gas, poisonous, flammable, n.o.s. (Inhalation Hazard Zone C)
3514	173	Adsorbed gas, poisonous, flammable, n.o.s. (Inhalation Hazard Zone D)
3514	173	Adsorbed gas, toxic, flammable, n.o.s.
3514	173	Adsorbed gas, toxic, flammable, n.o.s. (Inhalation Hazard Zone A)
3514	173	Adsorbed gas, toxic, flammable, n.o.s. (Inhalation Hazard Zone B)
3514	173	Adsorbed gas, toxic, flammable, n.o.s. (Inhalation Hazard Zone C)
3514	173	Adsorbed gas, toxic, flammable, n.o.s. (Inhalation Hazard Zone D)
3515	173	Adsorbed gas, poisonous, oxidizing, n.o.s.
3515	173	Adsorbed gas, poisonous, oxidizing, n.o.s. (Inhalation Hazard Zone A)

ID Guide **Name of Material**
No. No.

ID Guide **Name of Material**
No. No.

3515	173	Adsorbed gas, poisonous, oxidizing, n.o.s. (Inhalation Hazard Zone B)
3515	173	Adsorbed gas, poisonous, oxidizing, n.o.s. (Inhalation Hazard Zone C)
3515	173	Adsorbed gas, poisonous, oxidizing, n.o.s. (Inhalation Hazard Zone D)
3515	173	Adsorbed gas, toxic, oxidizing, n.o.s.
3515	173	Adsorbed gas, toxic, oxidizing, n.o.s. (Inhalation Hazard Zone A)
3515	173	Adsorbed gas, toxic, oxidizing, n.o.s. (Inhalation Hazard Zone B)
3515	173	Adsorbed gas, toxic, oxidizing, n.o.s. (Inhalation Hazard Zone C)
3515	173	Adsorbed gas, toxic, oxidizing, n.o.s. (Inhalation Hazard Zone D)
3516	173	Adsorbed gas, poisonous, corrosive, n.o.s.
3516	173	Adsorbed gas, poisonous, corrosive, n.o.s. (Inhalation Hazard Zone A)
3516	173	Adsorbed gas, poisonous, corrosive, n.o.s. (Inhalation Hazard Zone B)
3516	173	Adsorbed gas, poisonous, corrosive, n.o.s. (Inhalation Hazard Zone C)
3516	173	Adsorbed gas, poisonous, corrosive, n.o.s. (Inhalation Hazard Zone D)
3516	173	Adsorbed gas, toxic, corrosive, n.o.s.
3516	173	Adsorbed gas, toxic, corrosive, n.o.s. (Inhalation Hazard Zone A)

3516	173	Adsorbed gas, toxic, corrosive, n.o.s. (Inhalation Hazard Zone B)
3516	173	Adsorbed gas, toxic, corrosive, n.o.s. (Inhalation Hazard Zone C)
3516	173	Adsorbed gas, toxic, corrosive, n.o.s. (Inhalation Hazard Zone D)
3517	173	Adsorbed gas, poisonous, flammable, corrosive, n.o.s.
3517	173	Adsorbed gas, poisonous, flammable, corrosive, n.o.s. (Inhalation Hazard Zone A)
3517	173	Adsorbed gas, poisonous, flammable, corrosive, n.o.s. (Inhalation Hazard Zone B)
3517	173	Adsorbed gas, poisonous, flammable, corrosive, n.o.s. (Inhalation Hazard Zone C)
3517	173	Adsorbed gas, poisonous, flammable, corrosive, n.o.s. (Inhalation Hazard Zone D)
3517	173	Adsorbed gas, toxic, flammable, corrosive, n.o.s.
3517	173	Adsorbed gas, toxic, flammable, corrosive, n.o.s. (Inhalation Hazard Zone A)
3517	173	Adsorbed gas, toxic, flammable, corrosive, n.o.s. (Inhalation Hazard Zone B)
3517	173	Adsorbed gas, toxic, flammable, corrosive, n.o.s. (Inhalation Hazard Zone C)
3517	173	Adsorbed gas, toxic, flammable, corrosive, n.o.s. (Inhalation Hazard Zone D)
3518	173	Adsorbed gas, poisonous, oxidizing, corrosive, n.o.s.
3518	173	Adsorbed gas, poisonous, oxidizing, corrosive, n.o.s. (Inhalation Hazard Zone A)

ID No.	Guide No.	Name of Material
3518	173	Adsorbed gas, poisonous, oxidizing, corrosive, n.o.s. (Inhalation Hazard Zone B)
3518	173	Adsorbed gas, poisonous, oxidizing, corrosive, n.o.s. (Inhalation Hazard Zone C)
3518	173	Adsorbed gas, poisonous, oxidizing, corrosive, n.o.s. (Inhalation Hazard Zone D)
3518	173	Adsorbed gas, toxic, oxidizing, corrosive, n.o.s.
3518	173	Adsorbed gas, toxic, oxidizing, corrosive, n.o.s. (Inhalation Hazard Zone A)
3518	173	Adsorbed gas, toxic, oxidizing, corrosive, n.o.s. (Inhalation Hazard Zone B)
3518	173	Adsorbed gas, toxic, oxidizing, corrosive, n.o.s. (Inhalation Hazard Zone C)
3518	173	Adsorbed gas, toxic, oxidizing, corrosive, n.o.s. (Inhalation Hazard Zone D)
3519	173	Boron trifluoride, adsorbed
3520	173	Chlorine, adsorbed
3521	173	Silicon tetrafluoride, adsorbed
3522	173	Arsine, adsorbed
3523	173	Germane, adsorbed
3524	173	Phosphorus pentafluoride, adsorbed
3525	173	Phosphine, adsorbed
3526	173	Hydrogen selenide, adsorbed
3527	128P	Polyester resin kit, solid base material
3528	128	Engine, fuel cell, flammable liquid powered
3528	128	Engine, internal combustion, flammable liquid powered
3528	128	Machinery, fuel cell, flammable liquid powered

ID No.	Guide No.	Name of Material
3528	128	Machinery, internal combustion, flammable liquid powered
3529	115	Engine, fuel cell, flammable gas powered
3529	115	Engine, internal combustion, flammable gas powered
3529	115	Machinery, fuel cell, flammable gas powered
3529	115	Machinery, internal combustion, flammable gas powered
3530	171	Engine, internal combustion
3530	171	Machinery, internal combustion
3531	149P	Polymerizing substance, solid, stabilized, n.o.s.
3532	149P	Polymerizing substance, liquid, stabilized, n.o.s.
3533	150P	Polymerizing substance, solid, temperature controlled, n.o.s.
3534	150P	Polymerizing substance, liquid, temperature controlled, n.o.s.
3535	134	Toxic solid, flammable, inorganic, n.o.s.
3536	147	Lithium batteries installed in cargo transport unit (lithium ion batteries)
3536	138	Lithium batteries installed in cargo transport unit (lithium metal batteries)
3537	115	Articles containing flammable gas, n.o.s.
3538	120	Articles containing non-flammable, non-toxic gas, n.o.s.
3539	123	Articles containing toxic gas, n.o.s.
3540	127	Articles containing flammable liquid, n.o.s.
3541	133	Articles containing flammable solid, n.o.s.

ID No. **Guide No.** **Name of Material**

3542 **135** Articles containing a substance liable to spontaneous combustion, n.o.s.

3543 **138** Articles containing a substance which in contact with water emits flammable gases, n.o.s.

3544 **140** Articles containing oxidizing substance, n.o.s.

3545 **145** Articles containing organic peroxide, n.o.s.

3546 **151** Articles containing toxic substance, n.o.s.

3547 **154** Articles containing corrosive substance, n.o.s.

3548 **171** Articles containing miscellaneous dangerous goods, n.o.s.

3549 **158** Medical waste, category A, affecting animals only, solid

3549 **158** Medical waste, category A, affecting humans, solid

3550 **151** Cobalt dihydroxide powder

3551 **147** Sodium ion batteries

3552 **147** Sodium ion batteries contained in equipment

3552 **147** Sodium ion batteries packed with equipment

3553 **116** Disilane

3554 **172** Gallium contained in manufactured articles

3555 **113** Trifluoromethyltetrazole-sodium salt in acetone

3556 **147** Vehicle, lithium ion battery powered

3557 **138** Vehicle, lithium metal battery powered

3558 **147** Vehicle, sodium ion battery powered

3559 **171** Fire suppressant dispersing devices

ID No. **Guide No.** **Name of Material**

3560 **153** Tetramethylammonium hydroxide aqueous solution with not less than 25% tetramethylammonium hydroxide

8000 **171** Consumer commodity

9035 **123** Gas identification set

9191 **143** Chlorine dioxide, hydrate, frozen

9202 **168** Carbon monoxide, refrigerated liquid (cryogenic liquid)

9206 **137** Methyl phosphonic dichloride

9260 **169** Aluminum, molten

9263 **156** Chloropivaloyl chloride

9264 **151** 3,5-Dichloro-2,4,6-trifluoropyridine

9269 **132** Trimethoxysilane

ID Guide Name of Material
No. No.

ID Guide Name of Material
No. No.

INTRODUCTION TO BLUE SECTION

For entries **highlighted in green** follow these steps:

- **IF THERE IS NO FIRE:**
 - Go directly to **Table 1** (**green section**)
 - Look up the ID number and name of material
 - Identify initial isolation and protective action distances
 - Also consult the appropriate Orange Guide
- **IF A FIRE IS INVOLVED:**
 - Use the appropriate Orange Guide for **EVACUATION** distances
 - Also protect in downwind direction according to Table 1 for residual material release

Note 1: If the name in **Table 1** is shown with **(when spilled in water)**, these materials produce large amounts of Toxic Inhalation Hazard (TIH) (PIH in the US) gases when spilled in water. Some water-reactive materials are also TIH materials themselves (e.g., UN1746 (Bromine trifluoride), UN1836 (Thionyl chloride)). In these instances, two entries are provided in **Table 1** for land-based and water-based spills. If a water-reactive material only has one entry in Table 1 for **(when spilled in water)** and the product is NOT spilled in water, Table 1 and Table 2 do not apply. You will find safe distances in the appropriate Orange Guide.

Note 2: Explosives are not individually listed by their name because in an emergency situation, the response will be based only on the division of the explosive, not on the individual explosive.

For divisions 1.1, 1.2, 1.3 and 1.5, refer to GUIDE 112.

For divisions 1.4 and 1.6, refer to GUIDE 114.

Note 3: Chemical and biological warfare agents are now found in the “Criminal or Terrorist Use of Chemical, Biological and Radiological Agents” section.

Name of Material	Guide No.	ID No.	Name of Material	Guide No.	ID No.
Acetal	127	1088	Adsorbed gas, flammable, n.o.s.	174	3510
Acetaldehyde	129P	1089	Adsorbed gas, n.o.s.	174	3511
Acetaldehyde ammonia	171	1841	Adsorbed gas, oxidizing, n.o.s.	174	3513
Acetaldehyde oxime	129	2332	Adsorbed gas, poisonous, corrosive, n.o.s.	173	3516
Acetic acid, glacial	132	2789	Adsorbed gas, poisonous, corrosive, n.o.s. (Inhalation Hazard Zone A)	173	3516
Acetic acid, solution, more than 10% but not more than 80% acid	153	2790	Adsorbed gas, poisonous, corrosive, n.o.s. (Inhalation Hazard Zone B)	173	3516
Acetic acid, solution, more than 80% acid	132	2789	Adsorbed gas, poisonous, corrosive, n.o.s. (Inhalation Hazard Zone C)	173	3516
Acetic anhydride	137	1715	Adsorbed gas, poisonous, corrosive, n.o.s. (Inhalation Hazard Zone D)	173	3516
Acetone	127	1090	Adsorbed gas, poisonous, flammable, corrosive, n.o.s.	173	3517
Acetone cyanohydrin, stabilized	156	1541	Adsorbed gas, poisonous, flammable, corrosive, n.o.s. (Inhalation Hazard Zone A)	173	3517
Acetone oils	127	1091	Adsorbed gas, poisonous, flammable, corrosive, n.o.s. (Inhalation Hazard Zone B)	173	3517
Acetonitrile	127	1648	Adsorbed gas, poisonous, flammable, corrosive, n.o.s. (Inhalation Hazard Zone C)	173	3517
Acetyl bromide	156	1716	Adsorbed gas, poisonous, flammable, corrosive, n.o.s. (Inhalation Hazard Zone D)	173	3517
Acetyl chloride	155	1717	Adsorbed gas, poisonous, flammable, corrosive, n.o.s.	173	3514
Acetylene, dissolved	116	1001	Adsorbed gas, poisonous, flammable, corrosive, n.o.s. (Inhalation Hazard Zone A)	173	3514
Acetylene, solvent free	116	3374	Adsorbed gas, poisonous, flammable, corrosive, n.o.s. (Inhalation Hazard Zone B)	173	3514
Acetylene tetrabromide	159	2504	Adsorbed gas, poisonous, flammable, corrosive, n.o.s. (Inhalation Hazard Zone C)	173	3514
Acetyl iodide	156	1898	Adsorbed gas, poisonous, flammable, corrosive, n.o.s. (Inhalation Hazard Zone D)	173	3514
Acetyl methyl carbinol	127	2621	Adsorbed gas, poisonous, flammable, n.o.s. (Inhalation Hazard Zone A)	173	3514
Acid, sludge	153	1906	Adsorbed gas, poisonous, flammable, n.o.s. (Inhalation Hazard Zone B)	173	3514
Acid butyl phosphate	153	1718	Adsorbed gas, poisonous, flammable, n.o.s. (Inhalation Hazard Zone C)	173	3514
Acridine	153	2713	Adsorbed gas, poisonous, flammable, n.o.s. (Inhalation Hazard Zone D)	173	3514
Acrolein, stabilized	131P	1092	Adsorbed gas, poisonous, flammable, n.o.s.	173	3514
Acrolein dimer, stabilized	129P	2607	Adsorbed gas, poisonous, flammable, n.o.s. (Inhalation Hazard Zone A)	173	3514
Acrylamide, solid	153P	2074	Adsorbed gas, poisonous, flammable, n.o.s. (Inhalation Hazard Zone B)	173	3514
Acrylamide, solution	153P	3426	Adsorbed gas, poisonous, flammable, n.o.s. (Inhalation Hazard Zone C)	173	3514
Acrylic acid, stabilized	132P	2218	Adsorbed gas, poisonous, flammable, n.o.s. (Inhalation Hazard Zone D)	173	3514
Acrylonitrile, stabilized	131P	1093	Adsorbed gas, poisonous, flammable, n.o.s. (Inhalation Hazard Zone A)	173	3514
Adhesives (flammable)	128	1133	Adsorbed gas, poisonous, flammable, n.o.s. (Inhalation Hazard Zone B)	173	3514
Adiponitrile	153	2205	Adsorbed gas, poisonous, flammable, n.o.s. (Inhalation Hazard Zone C)	173	3514

Name of Material	Guide No.	ID No.	Name of Material	Guide No.	ID No.
Adsorbed gas, poisonous, flammable, n.o.s. (Inhalation Hazard Zone D)	173	3514	Adsorbed gas, poisonous, oxidizing, n.o.s. (Inhalation Hazard Zone D)	173	3515
Adsorbed gas, poisonous, n.o.s.	173	3512	Adsorbed gas, toxic, corrosive, n.o.s.	173	3516
Adsorbed gas, poisonous, n.o.s. (Inhalation Hazard Zone A)	173	3512	Adsorbed gas, toxic, corrosive, n.o.s. (Inhalation Hazard Zone A)	173	3516
Adsorbed gas, poisonous, n.o.s. (Inhalation Hazard Zone B)	173	3512	Adsorbed gas, toxic, corrosive, n.o.s. (Inhalation Hazard Zone B)	173	3516
Adsorbed gas, poisonous, n.o.s. (Inhalation Hazard Zone C)	173	3512	Adsorbed gas, toxic, corrosive, n.o.s. (Inhalation Hazard Zone C)	173	3516
Adsorbed gas, poisonous, n.o.s. (Inhalation Hazard Zone D)	173	3512	Adsorbed gas, toxic, corrosive, n.o.s. (Inhalation Hazard Zone D)	173	3516
Adsorbed gas, poisonous, oxidizing, corrosive, n.o.s.	173	3518	Adsorbed gas, toxic, flammable, corrosive, n.o.s.	173	3517
Adsorbed gas, poisonous, oxidizing, corrosive, n.o.s. (Inhalation Hazard Zone A)	173	3518	Adsorbed gas, toxic, flammable, corrosive, n.o.s. (Inhalation Hazard Zone A)	173	3517
Adsorbed gas, poisonous, oxidizing, corrosive, n.o.s. (Inhalation Hazard Zone B)	173	3518	Adsorbed gas, toxic, flammable, corrosive, n.o.s. (Inhalation Hazard Zone B)	173	3517
Adsorbed gas, poisonous, oxidizing, corrosive, n.o.s. (Inhalation Hazard Zone C)	173	3518	Adsorbed gas, toxic, flammable, corrosive, n.o.s. (Inhalation Hazard Zone C)	173	3517
Adsorbed gas, poisonous, oxidizing, corrosive, n.o.s. (Inhalation Hazard Zone D)	173	3518	Adsorbed gas, toxic, flammable, corrosive, n.o.s. (Inhalation Hazard Zone D)	173	3517
Adsorbed gas, poisonous, oxidizing, n.o.s.	173	3515	Adsorbed gas, toxic, flammable, n.o.s.	173	3514
Adsorbed gas, poisonous, oxidizing, n.o.s. (Inhalation Hazard Zone A)	173	3515	Adsorbed gas, toxic, flammable, n.o.s. (Inhalation Hazard Zone A)	173	3514
Adsorbed gas, poisonous, oxidizing, n.o.s. (Inhalation Hazard Zone B)	173	3515	Adsorbed gas, toxic, flammable, n.o.s. (Inhalation Hazard Zone B)	173	3514
Adsorbed gas, poisonous, oxidizing, n.o.s. (Inhalation Hazard Zone C)	173	3515	Adsorbed gas, toxic, flammable, n.o.s. (Inhalation Hazard Zone C)	173	3514

Name of Material	Guide No.	ID No.	Name of Material	Guide No.	ID No.
Adsorbed gas, toxic, flammable, n.o.s. (Inhalation Hazard Zone D)	173	3514	Air, refrigerated liquid (cryogenic liquid)	122	1003
Adsorbed gas, toxic, n.o.s.	173	3512	Air bag inflators	171	3268
Adsorbed gas, toxic, n.o.s. (Inhalation Hazard Zone A)	173	3512	Air bag modules	171	3268
Adsorbed gas, toxic, n.o.s. (Inhalation Hazard Zone B)	173	3512	Aircraft hydraulic power unit fuel tank	131	3165
Adsorbed gas, toxic, n.o.s. (Inhalation Hazard Zone C)	173	3512	Alcoholates solution, n.o.s., in alcohol	132	3274
Adsorbed gas, toxic, n.o.s. (Inhalation Hazard Zone D)	173	3512	Alcoholic beverages	127	3065
Adsorbed gas, toxic, oxidizing, corrosive, n.o.s.	173	3518	Alcohols, flammable, poisonous, n.o.s.	131	1986
Adsorbed gas, toxic, oxidizing, corrosive, n.o.s. (Inhalation Hazard Zone A)	173	3518	Alcohols, flammable, toxic, n.o.s.	131	1986
Adsorbed gas, toxic, oxidizing, corrosive, n.o.s. (Inhalation Hazard Zone B)	173	3518	Alcohols, n.o.s.	127	1987
Adsorbed gas, toxic, oxidizing, corrosive, n.o.s. (Inhalation Hazard Zone C)	173	3518	Aldehydes, flammable, poisonous, n.o.s.	131P	1988
Adsorbed gas, toxic, oxidizing, corrosive, n.o.s. (Inhalation Hazard Zone D)	173	3518	Aldehydes, flammable, toxic, n.o.s.	131P	1988
Adsorbed gas, toxic, oxidizing, n.o.s. (Inhalation Hazard Zone A)	173	3515	Aldehydes, n.o.s.	129P	1989
Adsorbed gas, toxic, oxidizing, n.o.s. (Inhalation Hazard Zone B)	173	3515	Aldol	153	2839
Adsorbed gas, toxic, oxidizing, n.o.s. (Inhalation Hazard Zone C)	173	3515	Alkali metal alcoholates, self-heating, corrosive, n.o.s.	136	3206
Adsorbed gas, toxic, oxidizing, n.o.s. (Inhalation Hazard Zone D)	173	3515	Alkali metal alloy, liquid, n.o.s.	138	1421
Adsorbed gas, toxic, n.o.s.	126	1950	Alkali metal amalgam, liquid	138	1389
Aerosols	126	1950	Alkali metal amalgam, solid	138	3401
Air, compressed	122	1002	Alkali metal amides	139	1390
			Alkali metal dispersion	138	1391
			Alkali metal dispersion, flammable	138	3482
			Alkaline earth metal alcoholates, n.o.s.	135	3205
			Alkaline earth metal alloy, n.o.s.	138	1393
			Alkaline earth metal amalgam, liquid	138	1392
			Alkaline earth metal amalgam, solid	138	3402

Name of Material	Guide No.	ID No.	Name of Material	Guide No.	ID No.
Alkaline earth metal dispersion	138	1391	Alkylsulphuric acids	156	2571
Alkaline earth metal dispersion, flammable	138	3482	Allyl acetate	131	2333
Alkaloid salts, liquid, n.o.s. (poisonous)	151	3140	Allyl alcohol	131	1098
Alkaloid salts, solid, n.o.s. (poisonous)	151	1544	Allylamine	131	2334
Alkaloids, liquid, n.o.s. (poisonous)	151	3140	Allyl bromide	131P	1099
Alkaloids, solid, n.o.s. (poisonous)	151	1544	Allyl chloride	131P	1100
Alkylphenols, liquid, n.o.s. (including C2-C12 homologues)	153	3145	Allyl chlorocarbonate	155	1722
Alkylphenols, solid, n.o.s. (including C2-C12 homologues)	153	2430	Allyl chloroformate	155	1722
Alkyl sulfonic acids, liquid, with more than 5% free sulfuric acid	153	2584	Allyl ethyl ether	131	2335
Alkyl sulfonic acids, liquid, with not more than 5% free sulfuric acid	153	2586	Allyl formate	131	2336
Alkyl sulfonic acids, solid, with more than 5% free sulfuric acid	153	2583	Allyl glycidyl ether	129	2219
Alkyl sulfonic acids, solid, with not more than 5% free sulfuric acid	153	2585	Allyl iodide	132	1723
Alkylsulphuric acids	156	2571	Allyl isothiocyanate, stabilized	131	1545
Alkyl sulphonic acids, liquid, with more than 5% free sulphuric acid	153	2584	Allyltrichlorosilane, stabilized	155	1724
Alkyl sulphonic acids, liquid, with not more than 5% free sulphuric acid	153	2586	alpha-Methylbenzyl alcohol, liquid	153	2937
Alkyl sulphonic acids, solid, with more than 5% free sulphuric acid	153	2583	alpha-Methylbenzyl alcohol, solid	153	3438
Alkyl sulphonic acids, solid, with not more than 5% free sulphuric acid	153	2585	alpha-Methylvaleraldehyde	130	2367
			alpha-Naphthylamine	153	2077
			alpha-Pinene	128	2368
			Aluminum, molten	169	9260
			Aluminum borohydride	135	2870
			Aluminum borohydride in devices	135	2870
			Aluminum bromide, anhydrous	137	1725
			Aluminum bromide, solution	154	2580
			Aluminum carbide	138	1394
			Aluminum chloride, anhydrous	137	1726
			Aluminum chloride, solution	154	2581
			Aluminum dross	138	3170
			Aluminum ferrosilicon powder	139	1395
			Aluminum hydride	138	2463

Name of Material	Guide No.	ID No.	Name of Material	Guide No.	ID No.
Aluminum nitrate	140	1438	Ammonia solution, with more than 50% ammonia	125	3318
Aluminum phosphide	139	1397	Ammonium arsenate	151	1546
Aluminum phosphide pesticide	157	3048	Ammonium bifluoride, solid	154	1727
Aluminum powder, coated	170	1309	Ammonium bifluoride, solution	154	2817
Aluminum powder, pyrophoric	135	1383	Ammonium dichromate	141	1439
Aluminum powder, uncoated	138	1396	Ammonium dinitro-o-cresolate, solid	141	1843
Aluminum remelting by-products	138	3170	Ammonium dinitro-o-cresolate, solution	141	3424
Aluminum resinate	133	2715	Ammonium fluoride	154	2505
Aluminum silicon powder, uncoated	138	1398	Ammonium fluorosilicate	151	2854
Aluminum smelting by-products	138	3170	Ammonium hydrogendifluoride, solid	154	1727
Amines, flammable, corrosive, n.o.s.	132	2733	Ammonium hydrogendifluoride, solution	154	2817
Amines, liquid, corrosive, flammable, n.o.s.	132	2734	Ammonium hydrogen sulfate	154	2506
Amines, liquid, corrosive, n.o.s.	153	2735	Ammonium hydrogen sulphate	154	2506
Amines, solid, corrosive, n.o.s.	154	3259	Ammonium hydroxide, with more than 10% but not more than 35% ammonia	154	2672
2-Amino-4-chlorophenol	151	2673	Ammonium metavanadate	154	2859
2-Amino-5-diethylaminopentane	153	2946	Ammonium nitrate, liquid (hot concentrated solution)	140	2426
2-Amino-4,6-dinitrophenol, wetted with not less than 20% water	113	3317	Ammonium nitrate, with not more than 0.2% combustible substances	140	1942
2-(2-Aminoethoxy)ethanol	154	3055	Ammonium nitrate based fertilizer	140	2067
N-Aminoethylpiperazine	153	2815	Ammonium nitrate based fertilizer	140	2071
Aminophenols	152	2512	Ammonium nitrate emulsion	140	3375
Aminopyridines	153	2671	Ammonium nitrate-fuel oil mixtures	112	—
Ammonia, anhydrous	125	1005	Ammonium nitrate gel	140	3375
Ammonia solution, with more than 10% but not more than 35% ammonia	154	2672	Ammonium nitrate suspension	140	3375
Ammonia solution, with more than 35% but not more than 50% ammonia	125	2073	Ammonium perchlorate	143	1442

Name of Material	Guide No.	ID No.	Name of Material	Guide No.	ID No.
Ammonium persulfate	140	1444	Anisoyl chloride	156	1729
Ammonium persulphate	140	1444	Antimony compound, inorganic, liquid, n.o.s.	157	3141
Ammonium picrate, wetted with not less than 10% water	113	1310	Antimony compound, inorganic, solid, n.o.s.	157	1549
Ammonium polysulfide, solution	154	2818	Antimony lactate	151	1550
Ammonium polysulphide, solution	154	2818	Antimony pentachloride, liquid	157	1730
Ammonium polyvanadate	151	2861	Antimony pentachloride, solution	157	1731
Ammonium silicofluoride	151	2854	Antimony pentafluoride	157	1732
Ammonium sulfide, solution	132	2683	Antimony potassium tartrate	151	1551
Ammonium sulphide, solution	132	2683	Antimony powder	170	2871
Ammunition, poisonous, non-explosive	151	2016	Antimony trichloride	157	1733
Ammunition, tear-producing, non-explosive	159	2017	Antimony trichloride, liquid	157	1733
Ammunition, toxic, non-explosive	151	2016	Antimony trichloride, solid	157	1733
Amyl acetates	129	1104	Aqua regia	157	1798
Amyl acid phosphate	153	2819	Argon	120	1006
Amylamine	132	1106	Argon, compressed	120	1006
Amyl butyrates	130	2620	Argon, refrigerated liquid (cryogenic liquid)	120	1951
Amyl chloride	129	1107	Arsenic	152	1558
n-Amylene	128	1108	Arsenic acid, liquid	154	1553
Amyl formates	129	1109	Arsenic acid, solid	154	1554
Amyl mercaptan	130	1111	Arsenical dust	152	1562
n-Amyl methyl ketone	127	1110	Arsenical pesticide, liquid, flammable, poisonous	131	2760
Amyl nitrate	128	1112	Arsenical pesticide, liquid, flammable, toxic	131	2760
Amyl nitrite	129	1113	Arsenical pesticide, liquid, poisonous	151	2994
Amyltrichlorosilane	156	1728	Arsenical pesticide, liquid, poisonous, flammable	131	2993
Anhydrous ammonia	125	1005	Arsenical pesticide, liquid, toxic	151	2994
Aniline	153	1547	Arsenical pesticide, liquid, toxic, flammable	131	2993
Aniline hydrochloride	153	1548			
Anisidines	153	2431			
Anisole	128	2222			

Name of Material	Guide No.	ID No.	Name of Material	Guide No.	ID No.
Arsenical pesticide, solid, poisonous	151	2759	Articles containing toxic substance, n.o.s.	151	3546
Arsenical pesticide, solid, toxic	151	2759	Articles, pressurized, hydraulic (containing non-flammable gas)	126	3164
Arsenic bromide	151	1555	Articles, pressurized, pneumatic (containing non-flammable gas)	126	3164
Arsenic chloride	157	1560	Aryl sulfonic acids, liquid, with more than 5% free sulfuric acid	153	2584
Arsenic compound, liquid, n.o.s.	152	1556	Aryl sulfonic acids, liquid, with not more than 5% free sulfuric acid	153	2586
Arsenic compound, solid, n.o.s.	152	1557	Aryl sulfonic acids, solid, with more than 5% free sulfuric acid	153	2583
Arsenic pentoxide	151	1559	Aryl sulfonic acids, solid, with not more than 5% free sulfuric acid	153	2585
Arsenic trichloride	157	1560	Aryl sulphonic acids, liquid, with more than 5% free sulphuric acid	153	2584
Arsenic trioxide	151	1561	Aryl sulphonic acids, liquid, with not more than 5% free sulphuric acid	153	2586
Arsine	119	2188	Aryl sulphonic acids, solid, with more than 5% free sulphuric acid	153	2583
Arsine, adsorbed	173	3522	Articles containing a substance liable to spontaneous combustion, n.o.s.	135	3542
Articles containing a substance liable to spontaneous combustion, n.o.s.	135	3542	Articles containing a substance which in contact with water emits flammable gases, n.o.s.	138	3543
Articles containing a substance which in contact with water emits flammable gases, n.o.s.	138	3543	Articles containing corrosive substance, n.o.s.	154	3547
Articles containing corrosive substance, n.o.s.	154	3547	Articles containing flammable gas, n.o.s.	115	3537
Articles containing flammable gas, n.o.s.	115	3537	Articles containing flammable liquid, n.o.s.	127	3540
Articles containing flammable liquid, n.o.s.	127	3540	Articles containing flammable solid, n.o.s.	133	3541
Articles containing flammable solid, n.o.s.	133	3541	Articles containing miscellaneous dangerous goods, n.o.s.	171	3548
Articles containing miscellaneous dangerous goods, n.o.s.	171	3548	Articles containing non-flammable, non-toxic gas, n.o.s.	120	3538
Articles containing non-flammable, non-toxic gas, n.o.s.	120	3538	Articles containing oxidizing substance, n.o.s.	140	3544
Articles containing oxidizing substance, n.o.s.	140	3544	Articles containing organic peroxide, n.o.s.	145	3545
Articles containing organic peroxide, n.o.s.	145	3545	Articles containing toxic gas, n.o.s.	123	3539
Articles containing toxic gas, n.o.s.	123	3539	Asbestos	171	2212
			Asbestos, amphibole	171	2212
			Asbestos, chrysotile	171	2590
			Asphalt	130	1999
			Asphalt, cut back	130	1999
			Aviation regulated liquid, n.o.s.	171	3334
			Aviation regulated solid, n.o.s.	171	3335
			Azodicarbonamide	149	3242
			Barium	138	1400

Name of Material	Guide No.	ID No.	Name of Material	Guide No.	ID No.
Barium alloys, pyrophoric	135	1854	Battery-powered vehicle (wet battery)	154	3171
Barium azide, wetted with not less than 50% water	113	1571	Battery-powered vehicle (with lithium ion batteries)	147	3171
Barium bromate	141	2719	Battery-powered vehicle (with sodium batteries)	138	3171
Barium chlorate, solid	141	1445	Benzaldehyde	171	1990
Barium chlorate, solution	141	3405	Benzene	130	1114
Barium compound, n.o.s.	154	1564	Benzene phosphorus dichloride	137	2798
Barium cyanide	157	1565	Benzene phosphorus thiodichloride	137	2799
Barium hypochlorite, with more than 22% available chlorine	141	2741	Benzenesulfonyl chloride	156	2225
Barium nitrate	141	1446	Benzenesulphonyl chloride	156	2225
Barium oxide	157	1884	Benzidine	153	1885
Barium perchlorate, solid	141	1447	Benzonitrile	152	2224
Barium perchlorate, solution	141	3406	Benzoquinone	153	2587
Barium permanganate	141	1448	Benzotrichloride	156	2226
Barium peroxide	141	1449	Benzotrifluoride	127	2338
Batteries, containing metallic sodium or sodium alloy	138	3292	Benzoyl chloride	137	1736
Batteries, containing sodium	138	3292	Benzyl bromide	156	1737
Batteries, dry, containing potassium hydroxide solid	154	3028	Benzyl chloride	156	1738
Batteries, nickel-metal hydride	171	3496	Benzyl chloroformate	137	1739
Batteries, wet, filled with acid	154	2794	Benzylidimethylamine	132	2619
Batteries, wet, filled with alkali	154	2795	Benzylidene chloride	156	1886
Batteries, wet, non-spillable	154	2800	Benzyl iodide	156	2653
Battery fluid, acid	157	2796	Beryllium compound, n.o.s.	154	1566
Battery fluid, alkali	154	2797	Beryllium nitrate	141	2464
Battery-powered equipment (wet battery)	154	3171	Beryllium powder	134	1567
Battery-powered equipment (with lithium ion batteries)	147	3171	beta-Naphthylamine, solid	153	1650
Battery-powered equipment (with lithium metal batteries)	138	3171	beta-Naphthylamine, solution	153	3411
Battery-powered equipment (with sodium batteries)	138	3171	Bhusa, wet, damp or contaminated with oil	133	1327
			Bicyclo[2.2.1]hepta-2,5-diene, stabilized	128P	2251

Name of Material	Guide No.	ID No.	Name of Material	Guide No.	ID No.
Biological substance, category B	158	3373	Boron trifluoride acetic acid complex, liquid	157	1742
(Bio)Medical waste, n.o.s.	158	3291	Boron trifluoride acetic acid complex, solid	157	3419
Bipyridilium pesticide, liquid, flammable, poisonous	131	2782	Boron trifluoride diethyl etherate	132	2604
Bipyridilium pesticide, liquid, flammable, toxic	131	2782	Boron trifluoride dimethyl etherate	139	2965
Bipyridilium pesticide, liquid, poisonous	151	3016	Boron trifluoride propionic acid complex, liquid	157	1743
Bipyridilium pesticide, liquid, poisonous, flammable	131	3015	Boron trifluoride propionic acid complex, solid	157	3420
Bipyridilium pesticide, liquid, toxic	151	3016	Bromates, inorganic, aqueous solution, n.o.s.	140	3213
Bipyridilium pesticide, liquid, toxic, flammable	131	3015	Bromates, inorganic, n.o.s.	140	1450
Bipyridilium pesticide, solid, poisonous	151	2781	Bromine	154	1744
Bipyridilium pesticide, solid, toxic	151	2781	Bromine, solution	154	1744
Bisulfates, aqueous solution	154	2837	Bromine, solution (Inhalation Hazard Zone A)	154	1744
Bisulfites, aqueous solution, n.o.s.	154	2693	Bromine, solution (Inhalation Hazard Zone B)	154	1744
Bisulphates, aqueous solution	154	2837	Bromine chloride	124	2901
Bisulphites, aqueous solution, n.o.s.	154	2693	Bromine pentafluoride	144	1745
Blasting agent, n.o.s.	112	— —	Bromine trifluoride	144	1746
Bleaching powder	140	2208	Bromoacetic acid, solid	156	3425
Bombs, smoke, non-explosive, with corrosive liquid, without initiating device	153	2028	Bromoacetic acid, solution	156	1938
Borneol	133	1312	Bromoacetone	131	1569
Boron tribromide	157	2692	Bromoacetyl bromide	156	2513
Boron trichloride	125	1741	Bromobenzene	130	2514
Boron trifluoride	125	1008	Bromobenzyl cyanides, liquid	159	1694
Boron trifluoride, adsorbed	173	3519	Bromobenzyl cyanides, solid	159	3449
Boron trifluoride, compressed	125	1008	1-Bromobutane	130	1126
Boron trifluoride, dihydrate	157	2851	2-Bromobutane	130	2339
			Bromochloromethane	160	1887
			1-Bromo-3-chloropropane	159	2688
			2-Bromoethyl ethyl ether	130	2340

Name of Material	Guide No.	ID No.	Name of Material	Guide No.	ID No.
Bromoform	159	2515	n-Butyl formate	129	1128
1-Bromo-3-methylbutane	130	2341	tert-Butyl hypochlorite	135	3255
Bromomethylpropanes	130	2342	N,n-Butylimidazole	152	2690
2-Bromo-2-nitropropane-1,3-diol	133	3241	n-Butyl isocyanate	155P	2485
2-Bromopentane	130	2343	tert-Butyl isocyanate	155	2484
Bromopropanes	129	2344	Butyl mercaptan	130	2347
3-Bromopropyne	130	2345	n-Butyl methacrylate, stabilized	130P	2227
Bromotrifluoroethylene	116	2419	Butyl methyl ether	127	2350
Bromotrifluoromethane	126	1009	Butyl nitrites	129	2351
Brucine	151	1570	Butyl propionates	130	1914
Butadienes, stabilized	116P	1010	Butyltoluenes	152	2667
Butadienes and hydrocarbon mixture, stabilized	116P	1010	Butyltrichlorosilane	155	1747
Butane	115	1011	5-tert-Butyl-2,4,6-trinitro-m-xylene	149	2956
Butane	115	1075	Butyl vinyl ether, stabilized	127P	2352
Butanedione	127	2346	1,4-Butynediol	153	2716
Butanols	129	1120	Butyraldehyde	129P	1129
Butyl acetates	129	1123	Butyraldoxime	129	2840
Butyl acid phosphate	153	1718	Butyric acid	153	2820
Butyl acrylates, stabilized	129P	2348	Butyric anhydride	156	2739
n-Butylamine	132	1125	Butyronitrile	131	2411
N-Butylaniline	153	2738	Butyryl chloride	155	2353
Butylbenzenes	128	2709	Cacodylic acid	151	1572
n-Butyl bromide	130	1126	Cadmium compound	154	2570
n-Butyl chloride	130	1127	Caesium	138	1407
n-Butyl chloroformate	155	2743	Caesium hydroxide	157	2682
tert-Butylcyclohexyl chloroformate	156	2747	Caesium hydroxide, solution	154	2681
Butylene	115	1012	Caesium nitrate	140	1451
Butylene	115	1075	Calcium	138	1401
1,2-Butylene oxide, stabilized	127P	3022	Calcium, pyrophoric	135	1855
Butyl ethers	128	1149	Calcium alloys, pyrophoric	135	1855

Name of Material	Guide No.	ID No.	Name of Material	Guide No.	ID No.
Calcium arsenate	151	1573	Calcium hypochlorite mixture, dry, corrosive, with more than 39% available chlorine (8.8% available oxygen)	140	3485
Calcium arsenate and calcium arsenite mixture, solid	151	1574	Calcium hypochlorite mixture, dry, with more than 10% but not more than 39% available chlorine	140	2208
Calcium carbide	138	1402	Calcium hypochlorite mixture, dry, with more than 39% available chlorine (8.8% available oxygen)	140	1748
Calcium chlorate	140	1452	Calcium manganese silicon	138	2844
Calcium chlorate, aqueous solution	140	2429	Calcium nitrate	140	1454
Calcium chlorite	140	1453	Calcium oxide	157	1910
Calcium cyanamide, with more than 0.1% calcium carbide	138	1403	Calcium perchlorate	140	1455
Calcium cyanide	157	1575	Calcium permanganate	140	1456
Calcium dithionite	135	1923	Calcium peroxide	140	1457
Calcium hydride	138	1404	Calcium phosphide	139	1360
Calcium hydrosulfite	135	1923	Calcium resinate	133	1313
Calcium hydrosulphite	135	1923	Calcium resinate, fused	133	1314
Calcium hypochlorite, dry	140	1748	Calcium silicide	138	1405
Calcium hypochlorite, dry, corrosive, with more than 39% available chlorine (8.8% available oxygen)	140	3485	Camphor, synthetic	133	2717
Calcium hypochlorite, hydrated, corrosive, with not less than 5.5% but not more than 16% water	140	3487	Camphor oil	128	1130
Calcium hypochlorite, hydrated, with not less than 5.5% but not more than 16% water	140	2880	Capacitor, asymmetric	171	3508
Calcium hypochlorite, hydrated mixture, corrosive, with not less than 5.5% but not more than 16% water	140	3487	Capacitor, electric double layer	171	3499
Calcium hypochlorite, hydrated mixture, with not less than 5.5% but not more than 16% water	140	2880	Caproic acid	153	2829
Calcium hypochlorite mixture, dry, corrosive, with more than 10% but not more than 39% available chlorine	140	3486	Carbamate pesticide, liquid, flammable, poisonous	131	2758
			Carbamate pesticide, liquid, flammable, toxic	131	2758
			Carbamate pesticide, liquid, poisonous	151	2992
			Carbamate pesticide, liquid, poisonous, flammable	131	2991
			Carbamate pesticide, liquid, toxic	151	2992

Name of Material	Guide No.	ID No.	Name of Material	Guide No.	ID No.
Carbamate pesticide, liquid, toxic, flammable	131	2991	Celluloid, in block, rods, rolls, sheets, tubes, etc., except scrap	133	2000
Carbamate pesticide, solid, poisonous	151	2757	Celluloid, scrap	135	2002
Carbamate pesticide, solid, toxic	151	2757	Cerium, slabs, ingots or rods	170	1333
Carbon, activated	133	1362	Cerium, turnings or gritty powder	138	3078
Carbon, animal or vegetable origin	133	1361	Cesium	138	1407
Carbon bisulfide	131	1131	Cesium hydroxide	157	2682
Carbon dioxide	120	1013	Cesium hydroxide, solution	154	2681
Carbon dioxide, compressed	120	1013	Cesium nitrate	140	1451
Carbon dioxide, refrigerated liquid	120	2187	Charcoal	133	1361
Carbon dioxide, solid	120	1845	Chemical kit	154	1760
Carbon disulfide	131	1131	Chemical kit	171	3316
Carbon disulphide	131	1131	Chemical sample, poisonous	151	3315
Carbon monoxide, compressed	119	1016	Chemical sample, toxic	151	3315
Carbon monoxide, refrigerated liquid (cryogenic liquid)	168	9202	Chemical under pressure, corrosive, n.o.s.	125	3503
Carbon tetrabromide	151	2516	Chemical under pressure, flammable, corrosive, n.o.s.	118	3505
Carbon tetrachloride	151	1846	Chemical under pressure, flammable, n.o.s.	115	3501
Carbonyl fluoride	125	2417	Chemical under pressure, flammable, poisonous, n.o.s.	119	3504
Carbonyl sulfide	119	2204	Chemical under pressure, flammable, toxic, n.o.s.	119	3504
Carbonyl sulphide	119	2204	Chemical under pressure, n.o.s.	126	3500
Castor beans, meal, pomace or flake	171	2969	Chemical under pressure, poisonous, n.o.s.	123	3502
Caustic alkali liquid, n.o.s.	154	1719	Chemical under pressure, toxic, n.o.s.	123	3502
Caustic potash, solid	154	1813	Chloral, anhydrous, stabilized	153	2075
Caustic potash, solution	154	1814	Chlorate and borate mixture	140	1458
Caustic soda, solid	154	1823	Chlorate and magnesium chloride mixture, solid	140	1459
Caustic soda, solution	154	1824			
Cells, containing metallic sodium or sodium alloy	138	3292			
Cells, containing sodium	138	3292			

Name of Material	Guide No.	ID No.	Name of Material	Guide No.	ID No.
Chlorate and magnesium chloride mixture, solution	140	3407	Chlorocresols, solution	152	2669
Chlorates, inorganic, aqueous solution, n.o.s.	140	3210	Chlorodifluorobromomethane	126	1974
Chlorates, inorganic, n.o.s.	140	1461	1-Chloro-1,1-difluoroethane	115	2517
Chloric acid, aqueous solution, with not more than 10% chloric acid	140	2626	Chlorodifluoromethane	126	1018
Chlorine	124	1017	Chlorodifluoromethane and chloropentafluoroethane mixture	126	1973
Chlorine, adsorbed	173	3520	Chlorodinitrobenzenes, liquid	153	1577
Chlorine dioxide, hydrate, frozen	143	9191	Chlorodinitrobenzenes, solid	153	3441
Chlorine pentafluoride	124	2548	2-Chloroethanal	153	2232
Chlorine trifluoride	124	1749	Chloroform	151	1888
Chlorite solution	154	1908	Chloroformates, poisonous, corrosive, flammable, n.o.s.	155	2742
Chlorites, inorganic, n.o.s.	143	1462	Chloroformates, poisonous, corrosive, n.o.s.	154	3277
Chloroacetaldehyde	153	2232	Chloroformates, toxic, corrosive, flammable, n.o.s.	155	2742
Chloroacetic acid, molten	153	3250	Chloroformates, toxic, corrosive, n.o.s.	154	3277
Chloroacetic acid, solid	153	1751	Chloromethyl chloroformate	157	2745
Chloroacetic acid, solution	153	1750	Chloromethyl ethyl ether	131	2354
Chloroacetone, stabilized	131	1695	3-Chloro-4-methylphenyl isocyanate, liquid	156	2236
Chloroacetonitrile	131	2668	3-Chloro-4-methylphenyl isocyanate, solid	156	3428
Chloroacetophenone, liquid	153	3416	Chloronitroanilines	153	2237
Chloroacetophenone, solid	153	1697	Chloronitrobenzenes, liquid	152	3409
Chloroacetyl chloride	156	1752	Chloronitrobenzenes, solid	152	1578
Chloroanilines, liquid	152	2019	Chloronitrotoluenes, liquid	152	2433
Chloroanilines, solid	152	2018	Chloronitrotoluenes, solid	152	3457
Chloroanisidines	152	2233	Chloropentafluoroethane	126	1020
Chlorobenzene	130	1134	Chlorophenolates, liquid	154	2904
Chlorobenzotrifluorides	130	2234	Chlorophenolates, solid	154	2905
Chlorobenzyl chlorides, liquid	153	2235	Chlorophenols, liquid	153	2021
Chlorobenzyl chlorides, solid	153	3427	Chlorophenols, solid	153	2020
Chlorobutanes	130	1127			
Chlorocresols, solid	152	3437			

Name of Material	Guide No.	ID No.	Name of Material	Guide No.	ID No.
Chlorophenyltrichlorosilane	156	1753	Chlorotoluenes	129	2238
Chloropicrin	154	1580	4-Chloro-o-toluidine hydrochloride, solid	153	1579
Chloropicrin and methyl bromide mixture	123	1581	4-Chloro-o-toluidine hydrochloride, solution	153	3410
Chloropicrin and methyl chloride mixture	119	1582	Chlorotoluidines, liquid	153	3429
Chloropicrin mixture, n.o.s.	154	1583	Chlorotoluidines, solid	153	2239
Chloropivaloyl chloride	156	9263	1-Chloro-2,2,2-trifluoroethane	126	1983
Chloroplatinic acid, solid	154	2507	Chlorotrifluoromethane	126	1022
Chloroprene, stabilized	131P	1991	Chlorotrifluoromethane and trifluoromethane azeotropic mixture with approximately 60% chlorotrifluoromethane	126	2599
1-Chloropropane	129	1278	Chromic acid, solution	154	1755
2-Chloropropane	129	2356	Chromic fluoride, solid	154	1756
3-Chloropropanol-1	153	2849	Chromic fluoride, solution	154	1757
2-Chloropropene	130P	2456	Chromium nitrate	141	2720
2-Chloropropionic acid	153	2511	Chromium oxychloride	137	1758
2-Chloropyridine	153	2822	Chromium trioxide, anhydrous	141	1463
Chlorosilanes, corrosive, flammable, n.o.s.	155	2986	Chromosulfuric acid	154	2240
Chlorosilanes, corrosive, n.o.s.	156	2987	Chromosulphuric acid	154	2240
Chlorosilanes, flammable, corrosive, n.o.s.	155	2985	Clinical waste, unspecified, n.o.s.	158	3291
Chlorosilanes, poisonous, corrosive, flammable, n.o.s.	155	3362	Coal gas, compressed	119	1023
Chlorosilanes, poisonous, corrosive, n.o.s.	156	3361	Coal tar distillates, flammable	128	1136
Chlorosilanes, toxic, corrosive, flammable, n.o.s.	155	3362	Coating solution	127	1139
Chlorosilanes, toxic, corrosive, n.o.s.	156	3361	Cobalt dihydroxide powder	151	3550
Chlorosilanes, water-reactive, flammable, corrosive, n.o.s.	139	2988	Cobalt naphthenates, powder	133	2001
Chlorosulfonic acid (with or without sulfur trioxide)	137	1754	Cobalt resinate, precipitated	133	1318
Chlorosulphonic acid (with or without sulphur trioxide)	137	1754	Combustible liquid, n.o.s.	128	1993
1-Chloro-1,2,2,2-tetrafluoroethane	126	1021	Compounds, cleaning liquid (corrosive)	154	1760
			Compounds, cleaning liquid (flammable)	128	1993
			Compounds, tree or weed killing, liquid (corrosive)	154	1760

Name of Material	Guide No.	ID No.	Name of Material	Guide No.	ID No.
Compounds, tree or weed killing, liquid (flammable)	128	1993	Compressed gas, poisonous, flammable, n.o.s. (Inhalation Hazard Zone B)	119	1953
Compounds, tree or weed killing, liquid (toxic)	153	2810	Compressed gas, poisonous, flammable, n.o.s. (Inhalation Hazard Zone C)	119	1953
Compressed gas, flammable, n.o.s.	115	1954	Compressed gas, poisonous, flammable, n.o.s. (Inhalation Hazard Zone D)	119	1953
Compressed gas, n.o.s.	126	1956	Compressed gas, poisonous, n.o.s.	123	1955
Compressed gas, oxidizing, n.o.s.	122	3156	Compressed gas, poisonous, n.o.s. (Inhalation Hazard Zone A)	123	1955
Compressed gas, poisonous, corrosive, n.o.s.	125	3304	Compressed gas, poisonous, n.o.s. (Inhalation Hazard Zone B)	123	1955
Compressed gas, poisonous, corrosive, n.o.s. (Inhalation Hazard Zone A)	125	3304	Compressed gas, poisonous, n.o.s. (Inhalation Hazard Zone C)	123	1955
Compressed gas, poisonous, corrosive, n.o.s. (Inhalation Hazard Zone B)	125	3304	Compressed gas, poisonous, n.o.s. (Inhalation Hazard Zone D)	124	3306
Compressed gas, poisonous, corrosive, n.o.s. (Inhalation Hazard Zone C)	125	3304	Compressed gas, poisonous, oxidizing, corrosive, n.o.s.	124	3306
Compressed gas, poisonous, corrosive, n.o.s. (Inhalation Hazard Zone D)	125	3304	Compressed gas, poisonous, oxidizing, corrosive, n.o.s. (Inhalation Hazard Zone A)	124	3306
Compressed gas, poisonous, flammable, corrosive, n.o.s.	119	3305	Compressed gas, poisonous, oxidizing, corrosive, n.o.s. (Inhalation Hazard Zone B)	124	3306
Compressed gas, poisonous, flammable, corrosive, n.o.s. (Inhalation Hazard Zone A)	119	3305	Compressed gas, poisonous, oxidizing, corrosive, n.o.s. (Inhalation Hazard Zone C)	124	3306
Compressed gas, poisonous, flammable, corrosive, n.o.s. (Inhalation Hazard Zone B)	119	3305	Compressed gas, poisonous, oxidizing, corrosive, n.o.s. (Inhalation Hazard Zone D)	124	3306
Compressed gas, poisonous, flammable, corrosive, n.o.s. (Inhalation Hazard Zone C)	119	3305	Compressed gas, poisonous, oxidizing, n.o.s.	124	3303
Compressed gas, poisonous, flammable, corrosive, n.o.s. (Inhalation Hazard Zone D)	119	3305	Compressed gas, poisonous, oxidizing, n.o.s. (Inhalation Hazard Zone A)	124	3303
Compressed gas, poisonous, flammable, n.o.s.	119	1953			
Compressed gas, poisonous, flammable, n.o.s. (Inhalation Hazard Zone A)	119	1953			

Name of Material	Guide No.	ID No.
Compressed gas, poisonous, oxidizing, n.o.s. (Inhalation Hazard Zone B)	124	3303
Compressed gas, poisonous, oxidizing, n.o.s. (Inhalation Hazard Zone C)	124	3303
Compressed gas, poisonous, oxidizing, n.o.s. (Inhalation Hazard Zone D)	124	3303
Compressed gas, toxic, corrosive, n.o.s.	125	3304
Compressed gas, toxic, corrosive, n.o.s. (Inhalation Hazard Zone A)	125	3304
Compressed gas, toxic, corrosive, n.o.s. (Inhalation Hazard Zone B)	125	3304
Compressed gas, toxic, corrosive, n.o.s. (Inhalation Hazard Zone C)	125	3304
Compressed gas, toxic, corrosive, n.o.s. (Inhalation Hazard Zone D)	125	3304
Compressed gas, toxic, flammable, corrosive, n.o.s.	119	3305
Compressed gas, toxic, flammable, corrosive, n.o.s. (Inhalation Hazard Zone A)	119	3305
Compressed gas, toxic, flammable, corrosive, n.o.s. (Inhalation Hazard Zone B)	119	3305
Compressed gas, toxic, flammable, corrosive, n.o.s. (Inhalation Hazard Zone C)	119	3305
Compressed gas, toxic, flammable, corrosive, n.o.s. (Inhalation Hazard Zone D)	119	3305
Compressed gas, toxic, flammable, n.o.s.	119	1953
Compressed gas, toxic, flammable, n.o.s. (Inhalation Hazard Zone A)	119	1953

Name of Material	Guide No.	ID No.
Compressed gas, toxic, flammable, n.o.s. (Inhalation Hazard Zone B)	119	1953
Compressed gas, toxic, flammable, n.o.s. (Inhalation Hazard Zone C)	119	1953
Compressed gas, toxic, flammable, n.o.s. (Inhalation Hazard Zone D)	119	1953
Compressed gas, toxic, n.o.s.	123	1955
Compressed gas, toxic, n.o.s. (Inhalation Hazard Zone A)	123	1955
Compressed gas, toxic, n.o.s. (Inhalation Hazard Zone B)	123	1955
Compressed gas, toxic, n.o.s. (Inhalation Hazard Zone C)	123	1955
Compressed gas, toxic, n.o.s. (Inhalation Hazard Zone D)	123	1955
Compressed gas, toxic, oxidizing, corrosive, n.o.s.	124	3306
Compressed gas, toxic, oxidizing, corrosive, n.o.s. (Inhalation Hazard Zone A)	124	3306
Compressed gas, toxic, oxidizing, corrosive, n.o.s. (Inhalation Hazard Zone B)	124	3306
Compressed gas, toxic, oxidizing, corrosive, n.o.s. (Inhalation Hazard Zone C)	124	3306
Compressed gas, toxic, oxidizing, corrosive, n.o.s. (Inhalation Hazard Zone D)	124	3306
Compressed gas, toxic, oxidizing, n.o.s.	124	3303
Compressed gas, toxic, oxidizing, n.o.s. (Inhalation Hazard Zone A)	124	3303
Compressed gas, toxic, oxidizing, n.o.s. (Inhalation Hazard Zone B)	124	3303
Compressed gas, toxic, oxidizing, n.o.s. (Inhalation Hazard Zone C)	124	3303

Name of Material	Guide No.	ID No.	Name of Material	Guide No.	ID No.
Compressed gas, toxic, oxidizing, n.o.s. (Inhalation Hazard Zone D)	124	3303	Corrosive liquid, poisonous, n.o.s.	154	2922
Consumer commodity	171	8000	Corrosive liquid, self-heating, n.o.s.	136	3301
Copper acetoarsenite	151	1585	Corrosive liquid, toxic, n.o.s.	154	2922
Copper arsenite	151	1586	Corrosive liquid, water-reactive, n.o.s.	138	3094
Copper based pesticide, liquid, flammable, poisonous	131	2776	Corrosive solid, acidic, inorganic, n.o.s.	154	3260
Copper based pesticide, liquid, flammable, toxic	131	2776	Corrosive solid, acidic, organic, n.o.s.	154	3261
Copper based pesticide, liquid, poisonous	151	3010	Corrosive solid, basic, inorganic, n.o.s.	154	3262
Copper based pesticide, liquid, poisonous, flammable	131	3009	Corrosive solid, basic, organic, n.o.s.	154	3263
Copper based pesticide, liquid, toxic	151	3010	Corrosive solid, flammable, n.o.s.	134	2921
Copper based pesticide, liquid, toxic, flammable	131	3009	Corrosive solid, n.o.s.	154	1759
Copper based pesticide, solid, poisonous	151	2775	Corrosive solid, oxidizing, n.o.s.	157	3084
Copper based pesticide, solid, toxic	151	2775	Corrosive solid, poisonous, n.o.s.	154	2923
Copper chlorate	140	2721	Corrosive solid, self-heating, n.o.s.	136	3095
Copper chloride	154	2802	Corrosive solid, toxic, n.o.s.	154	2923
Copper cyanide	151	1587	Corrosive solid, water-reactive, n.o.s.	138	3096
Copra	135	1363	Cotton	133	1365
Corrosive liquid, acidic, inorganic, n.o.s.	154	3264	Cotton, wet	133	1365
Corrosive liquid, acidic, organic, n.o.s.	153	3265	Cotton waste, oily	133	1364
Corrosive liquid, basic, inorganic, n.o.s.	154	3266	Coumarin derivative pesticide, liquid, flammable, poisonous	131	3024
Corrosive liquid, basic, organic, n.o.s.	153	3267	Coumarin derivative pesticide, liquid, flammable, toxic	131	3024
Corrosive liquid, flammable, n.o.s.	132	2920	Coumarin derivative pesticide, liquid, poisonous	151	3026
Corrosive liquid, n.o.s.	154	1760	Coumarin derivative pesticide, liquid, poisonous, flammable	131	3025
Corrosive liquid, oxidizing, n.o.s.	157	3093			

Name of Material	Guide No.	ID No.	Name of Material	Guide No.	ID No.
Coumarin derivative pesticide, liquid, toxic	151	3026	Cyclohexene	130	2256
Coumarin derivative pesticide, liquid, toxic, flammable	131	3025	Cyclohexenyltrichlorosilane	156	1762
Coumarin derivative pesticide, solid, poisonous	151	3027	Cyclohexyl acetate	130	2243
Coumarin derivative pesticide, solid, toxic	151	3027	Cyclohexylamine	132	2357
Cresols, liquid	153	2076	Cyclohexyl isocyanate	155	2488
Cresols, solid	153	3455	Cyclohexyl mercaptan	129	3054
Cresylic acid	153	2022	Cyclohexyltrichlorosilane	156	1763
Crotonaldehyde	131P	1143	Cyclooctadiene phosphines	135	2940
Crotonaldehyde, stabilized	131P	1143	Cyclooctadienes	130P	2520
Crotonic acid, liquid	153	3472	Cyclooctatetraene	128P	2358
Crotonic acid, solid	153	2823	Cyclopentane	128	1146
Crotonylene	128	1144	Cyclopentanol	129	2244
Cumene	130	1918	Cyclopentanone	128	2245
Cupriethylenediamine, solution	154	1761	Cyclopentene	128	2246
Cyanide solution, n.o.s.	157	1935	Cyclopropane	115	1027
Cyanides, inorganic, solid, n.o.s.	157	1588	Cymenes	130	2046
Cyanogen	119	1026	Dangerous goods in apparatus	171	3363
Cyanogen bromide	157	1889	Dangerous goods in articles	171	3363
Cyanogen chloride, stabilized	125	1589	Dangerous goods in machinery	171	3363
Cyanuric chloride	157	2670	Decaborane	134	1868
Cyclobutane	115	2601	Decahydronaphthalene	130	1147
Cyclobutyl chloroformate	155	2744	n-Decane	128	2247
1,5,9-Cyclododecatriene	153	2518	Denatured alcohol	127	1987
Cycloheptane	128	2241	Desensitized explosive, liquid, n.o.s.	113	3379
Cycloheptatriene	131	2603	Desensitized explosive, solid, n.o.s.	113	3380
Cycloheptene	128	2242	Deuterium, compressed	115	1957
Cyclohexane	128	1145	Devices, small, hydrocarbon gas powered, with release device	115	3150
Cyclohexanethiol	129	3054	Diacetone alcohol	129	1148
Cyclohexanone	127	1915	Diacetyl	127	2346
			Diallylamine	132	2359

Name of Material	Guide No.	ID No.	Name of Material	Guide No.	ID No.
Diallyl ether	131P	2360	Dichloromethane	160	1593
4,4'-Diaminodiphenylmethane	153	2651	1,1-Dichloro-1-nitroethane	153	2650
Di-n-amylamine	131	2841	Dichloropentanes	130	1152
Dibenzylchlorosilane	156	2434	Dichlorophenyl isocyanates	156	2250
Diborane	119	1911	Dichlorophenyltrichlorosilane	156	1766
Diborane mixtures	119	1911	1,2-Dichloropropane	130	1279
1,2-Dibromobutan-3-one	154	2648	1,3-Dichloropropanol-2	153	2750
Dibromochloropropanes	159	2872	Dichloropropenes	129	2047
Dibromodifluoromethane	171	1941	Dichlorosilane	119	2189
Dibromomethane	160	2664	1,2-Dichloro-1,1,2,2-tetrafluoroethane	126	1958
Di-n-butylamine	132	2248	3,5-Dichloro-2,4,6-trifluoropyridine	151	9264
Dibutylaminoethanol	153	2873	Dicyclohexylamine	153	2565
Dibutyl ethers	128	1149	Dicyclohexylammonium nitrite	133	2687
Dichloroacetic acid	153	1764	Dicyclopentadiene	130P	2048
1,3-Dichloroacetone	153	2649	1,2-Di-(dimethylamino) ethane	129	2372
Dichloroacetyl chloride	156	1765	Didymium nitrate	140	1465
Dichloroanilines, liquid	153	1590	Diesel fuel	128	1202
Dichloroanilines, solid	153	3442	Diesel fuel	128	1993
o-Dichlorobenzene	152	1591	Diethoxymethane	127	2373
2,2'-Dichlorodiethyl ether	152	1916	3,3-Diethoxypropene	127	2374
Dichlorodifluoromethane	126	1028	Diethylamine	132	1154
Dichlorodifluoromethane and difluoroethane azeotropic mixture with approximately 74% dichlorodifluoromethane	126	2602	2-Diethylaminoethanol	132	2686
Dichlorodimethyl ether, symmetrical	131	2249	3-Diethylaminopropylamine	132	2684
1,1-Dichloroethane	130	2362	N,N-Diethylaniline	153	2432
1,2-Dichloroethylene	130P	1150	Diethylbenzene	130	2049
Dichloroethyl ether	152	1916	Diethyl carbonate	128	2366
Dichlorofluoromethane	126	1029	Diethylchlorosilane	155	1767
Dichloroisocyanuric acid, dry	140	2465	Diethylenetriamine	154	2079
Dichloroisocyanuric acid salts	140	2465	Diethyl ether	127	1155
Dichloroisopropyl ether	153	2490	N,N-Diethylethylenediamine	132	2685
			Diethyl ketone	127	1156

Name of Material	Guide No.	ID No.	Name of Material	Guide No.	ID No.
Diethyl sulfate	152	1594	1,3-Dimethylbutylamine	132	2379
Diethyl sulfide	129	2375	Dimethylcarbamoyl chloride	156	2262
Diethyl sulphate	152	1594	Dimethyl carbonate	129	1161
Diethyl sulphide	129	2375	Dimethylcyclohexanes	128	2263
Diethylthiophosphoryl chloride	156	2751	N,N-Dimethylcyclohexylamine	132	2264
Difluorochloroethanes	115	2517	Dimethylcyclohexylamine	132	2264
1,1-Difluoroethane	115	1030	Dimethyldichlorosilane	155	1162
1,1-Difluoroethylene	116P	1959	Dimethyldiethoxysilane	127	2380
Difluoromethane	115	3252	Dimethyldioxanes	127	2707
Difluorophosphoric acid, anhydrous	154	1768	Dimethyl disulfide	131	2381
2,3-Dihydropyran	127	2376	Dimethyl disulphide	131	2381
Diisobutylamine	132	2361	Dimethyl ether	115	1033
Diisobutylene, isomeric compounds	128	2050	N,N-Dimethylformamide	129	2265
Diisobutyl ketone	128	1157	Dimethylhydrazine, symmetrical	131	2382
Diisooctyl acid phosphate	153	1902	Dimethylhydrazine, unsymmetrical	131	1163
Diisopropylamine	132	1158	2,2-Dimethylpropane	115	2044
Diisopropyl ether	127	1159	Dimethyl-N-propylamine	132	2266
Diketene, stabilized	131P	2521	Dimethyl sulfate	156	1595
1,1-Dimethoxyethane	127	2377	Dimethyl sulfide	130	1164
1,2-Dimethoxyethane	127	2252	Dimethyl sulphate	156	1595
Dimethylamine, anhydrous	118	1032	Dimethyl sulphide	130	1164
Dimethylamine, aqueous solution	132	1160	Dimethyl thiophosphoryl chloride	156	2267
Dimethylamine, solution	132	1160	Dinitroanilines	153	1596
2-Dimethylaminoacetonitrile	131	2378	Dinitrobenzenes, liquid	152	1597
2-Dimethylaminoethanol	132	2051	Dinitrobenzenes, solid	152	3443
2-Dimethylaminoethyl acrylate, stabilized	152P	3302	Dinitro-o-cresol	153	1598
2-Dimethylaminoethyl methacrylate, stabilized	153P	2522	Dinitrogen tetroxide	124	1067
N,N-Dimethylaniline	153	2253	Dinitrophenol, solution	153	1599
2,3-Dimethylbutane	128	2457	Dinitrophenol, wetted with not less than 15% water	113	1320

Name of Material	Guide No.	ID No.	Name of Material	Guide No.	ID No.
Dinitrophenolates, wetted with not less than 15% water	113	1321	Dodecyltrichlorosilane	156	1771
Dinitroresorcinol, wetted with not less than 15% water	113	1322	Dry ice	120	1845
Dinitrotoluenes, liquid	152	2038	Dye, liquid, corrosive, n.o.s.	154	2801
Dinitrotoluenes, molten	152	1600	Dye, liquid, poisonous, n.o.s.	151	1602
Dinitrotoluenes, solid	152	3454	Dye, liquid, toxic, n.o.s.	151	1602
Dioxane	127	1165	Dye, solid, corrosive, n.o.s.	154	3147
Dioxolane	127	1166	Dye, solid, poisonous, n.o.s.	151	3143
Dipentene	128	2052	Dye, solid, toxic, n.o.s.	151	3143
Diphenylamine chloroarsine	154	1698	Dye intermediate, liquid, corrosive, n.o.s.	154	2801
Diphenylchloroarsine, liquid	151	1699	Dye intermediate, liquid, poisonous, n.o.s.	151	1602
Diphenylchloroarsine, solid	151	3450	Dye intermediate, liquid, toxic, n.o.s.	151	1602
Diphenyldichlorosilane	156	1769	Dye intermediate, solid, corrosive, n.o.s.	154	3147
Diphenylmethyl bromide	153	1770	Dye intermediate, solid, poisonous, n.o.s.	151	3143
Dipicryl sulfide, wetted with not less than 10% water	113	2852	Dye intermediate, solid, toxic, n.o.s.	151	3143
Dipicryl sulphide, wetted with not less than 10% water	113	2852	Elevated temperature liquid, flammable, n.o.s., with flash point above 37.8°C (100°F), at or above its flash point	128	3256
Dipropylamine	132	2383	Elevated temperature liquid, flammable, n.o.s., with flash point above 60°C (140°F), at or above its flash point	128	3256
Di-n-propyl ether	127	2384	Elevated temperature liquid, n.o.s., at or above 100°C (212°F), and below its flash point	171	3257
Dipropyl ketone	128	2710	Elevated temperature solid, n.o.s., at or above 240°C (464°F)	171	3258
Disilane	116	3553	Engine, fuel cell, flammable gas powered	115	3529
Disinfectant, liquid, corrosive, n.o.s.	153	1903	Engine, fuel cell, flammable liquid powered	128	3528
Disinfectant, liquid, poisonous, n.o.s.	151	3142	Engine, internal combustion	171	3530
Disinfectant, liquid, toxic, n.o.s.	151	3142			
Disinfectant, solid, poisonous, n.o.s.	151	1601			
Disinfectant, solid, toxic, n.o.s.	151	1601			
Disodium trioxosilicate	154	3253			
Dispersant gases, n.o.s. (flammable)	115	1954			
Divinyl ether, stabilized	128P	1167			

Name of Material	Guide No.	ID No.	Name of Material	Guide No.	ID No.
Engine, internal combustion, flammable gas powered	115	3529	Ethylamine, aqueous solution, with not less than 50% but not more than 70% ethylamine	132	2270
Engine, internal combustion, flammable liquid powered	128	3528	Ethyl amyl ketone	128	2271
Environmentally hazardous substance, liquid, n.o.s.	171	3082	2-Ethylaniline	153	2273
Environmentally hazardous substance, solid, n.o.s.	171	3077	N-Ethylaniline	153	2272
Epibromohydrin	131	2558	Ethylbenzene	130	1175
Epichlorohydrin	131P	2023	N-Ethyl-N-benzylaniline	153	2274
1,2-Epoxy-3-ethoxypropane	127	2752	N-Ethylbenzyltoluidines, liquid	153	2753
Esters, n.o.s.	127	3272	N-Ethylbenzyltoluidines, solid	153	3460
Ethane	115	1035	Ethyl borate	129	1176
Ethane, compressed	115	1035	Ethyl bromide	131	1891
Ethane, refrigerated liquid	115	1961	Ethyl bromoacetate	155	1603
Ethane-propane mixture, refrigerated liquid	115	1961	2-Ethylbutanol	129	2275
Ethanol	127	1170	2-Ethylbutyl acetate	130	1177
Ethanol and gasoline mixture, with more than 10% ethanol	127	3475	Ethyl butyl ether	127	1179
Ethanol and motor spirit mixture, with more than 10% ethanol	127	3475	2-Ethylbutyraldehyde	130	1178
Ethanol and petrol mixture, with more than 10% ethanol	127	3475	Ethyl butyrate	130	1180
Ethanol, solution	127	1170	Ethyl chloride	115	1037
Ethanolamine	153	2491	Ethyl chloroacetate	155	1181
Ethanolamine, solution	153	2491	Ethyl chloroformate	155	1182
Ethers, n.o.s.	127	3271	Ethyl 2-chloropropionate	129	2935
Ethyl acetate	129	1173	Ethyl chlorothioformate	155	2826
Ethylacetylene, stabilized	116P	2452	Ethyl crotonate	130	1862
Ethyl acrylate, stabilized	129P	1917	Ethyl dichloroarsine	151	1892
Ethyl alcohol	127	1170	Ethyl dichlorosilane	139	1183
Ethyl alcohol, solution	127	1170	Ethylene	116P	1962
Ethylamine	118	1036	Ethylene, acetylene and propylene mixture, refrigerated liquid containing at least 71.5% ethylene with not more than 22.5% acetylene and not more than 6% propylene	115	3138
			Ethylene, compressed	116P	1962

Name of Material	Guide No.	ID No.	Name of Material	Guide No.	ID No.
Ethylene, refrigerated liquid (cryogenic liquid)	115	1038	Ethylene oxide and propylene oxide mixture, with not more than 30% ethylene oxide	131P	2983
Ethylene chlorohydrin	131	1135	Ethylene oxide and tetrafluoroethane mixture, with not more than 5.6% ethylene oxide	126	3299
Ethylenediamine	132	1604	Ethylene oxide with nitrogen	119P	1040
Ethylene dibromide	154	1605	Ethyl ether	127	1155
Ethylene dichloride	131	1184	Ethyl fluoride	115	2453
Ethylene glycol diethyl ether	127	1153	Ethyl formate	129	1190
Ethylene glycol monoethyl ether	127	1171	Ethylhexaldehyde	129	1191
Ethylene glycol monoethyl ether acetate	129	1172	2-Ethylhexylamine	132	2276
Ethylene glycol monomethyl ether	127	1188	2-Ethylhexyl chloroformate	156	2748
Ethylene glycol monomethyl ether acetate	129	1189	Ethyl isobutyrate	129	2385
Ethyleneimine, stabilized	131P	1185	Ethyl isocyanate	155	2481
Ethylene oxide	119P	1040	Ethyl lactate	129	1192
Ethylene oxide and carbon dioxide mixture, with more than 9% but not more than 87% ethylene oxide	115	1041	Ethyl mercaptan	129	2363
Ethylene oxide and carbon dioxide mixture, with more than 87% ethylene oxide	119P	3300	Ethyl methacrylate, stabilized	130P	2277
Ethylene oxide and carbon dioxide mixture, with not more than 9% ethylene oxide	126	1952	Ethyl methyl ether	115	1039
Ethylene oxide and chlorotetrafluoroethane mixture, with not more than 8.8% ethylene oxide	126	3297	Ethyl methyl ketone	127	1193
Ethylene oxide and dichlorodifluoromethane mixture, with not more than 12.5% ethylene oxide	126	3070	Ethyl nitrite, solution	131	1194
Ethylene oxide and pentafluoroethane mixture, with not more than 7.9% ethylene oxide	126	3298	Ethyl orthoformate	129	2524
			Ethyl oxalate	156	2525
			Ethylphenyldichlorosilane	156	2435
			Ethyl phosphonothioic dichloride, anhydrous	154	2927
			Ethyl phosphonous dichloride, anhydrous	135	2845
			Ethyl phosphorodichloridate	154	2927
			1-Ethylpiperidine	132	2386
			Ethyl propionate	129	1195
			Ethyl propyl ether	127	2615
			Ethyl silicate	129	1292
			N-Ethyltoluidines	153	2754

Name of Material	Guide No.	ID No.	Name of Material	Guide No.	ID No.
Ethyltrichlorosilane	155	1196	Fibres, animal or vegetable or synthetic, n.o.s. with oil	133	1373
Explosives, division 1.1, 1.2, 1.3 or 1.5	112	— —	Fibres, vegetable, dry	133	3360
Explosives, division 1.4 or 1.6	114	— —	Fibres impregnated with weakly nitrated nitrocellulose, n.o.s.	133	1353
Extracts, aromatic, liquid	127	1169	Films, nitrocellulose base	133	1324
Extracts, flavoring, liquid	127	1197	Fire extinguisher charges, corrosive liquid	154	1774
Extracts, flavouring, liquid	127	1197	Fire extinguishers with compressed or liquefied gas	126	1044
Extracts, liquid	127	1197	Firelighters, solid, with flammable liquid	133	2623
Fabrics, animal or vegetable or synthetic, n.o.s. with oil	133	1373	Fire suppressant dispersing devices	171	3559
Fabrics impregnated with weakly nitrated nitrocellulose, n.o.s.	133	1353	First aid kit	171	3316
Ferric arsenate	151	1606	Fish meal, stabilized	171	2216
Ferric arsenite	151	1607	Fish meal, unstabilized	133	1374
Ferric chloride, anhydrous	157	1773	Fish scrap, stabilized	171	2216
Ferric chloride, solution	154	2582	Fish scrap, unstabilized	133	1374
Ferric nitrate	140	1466	Flammable liquid, corrosive, n.o.s.	132	2924
Ferrocerium	170	1323	Flammable liquid, n.o.s.	128	1993
Ferrosilicon	139	1408	Flammable liquid, poisonous, corrosive, n.o.s.	131	3286
Ferrous arsenate	151	1608	Flammable liquid, poisonous, n.o.s.	131	1992
Ferrous chloride, solid	154	1759	Flammable liquid, toxic, corrosive, n.o.s.	131	3286
Ferrous chloride, solution	154	1760	Flammable liquid, toxic, n.o.s.	131	1992
Ferrous metal borings, shavings, turnings or cuttings	170	2793	Flammable solid, corrosive, inorganic, n.o.s.	134	3180
Fertilizer, ammoniating solution, with free ammonia	125	1043	Flammable solid, corrosive, organic, n.o.s.	134	2925
Fibers, animal or vegetable, burnt, wet or damp	133	1372	Flammable solid, inorganic, n.o.s.	133	3178
Fibers, animal or vegetable or synthetic, n.o.s. with oil	133	1373	Flammable solid, organic, molten, n.o.s.	133	3176
Fibers, vegetable, dry	133	3360			
Fibers impregnated with weakly nitrated nitrocellulose, n.o.s.	133	1353			
Fibres, animal or vegetable, burnt, wet or damp	133	1372			

Name of Material	Guide No.	ID No.	Name of Material	Guide No.	ID No.
Flammable solid, organic, n.o.s.	133	1325	Formic acid, with not less than 10% but not more than 85% acid	153	3412
Flammable solid, oxidizing, n.o.s.	140	3097	Fuel, aviation, turbine engine	128	1863
Flammable solid, poisonous, inorganic, n.o.s.	134	3179	Fuel cell cartridges contained in equipment, containing corrosive substances	153	3477
Flammable solid, poisonous, organic, n.o.s.	134	2926	Fuel cell cartridges contained in equipment, containing flammable liquids	128	3473
Flammable solid, toxic, inorganic, n.o.s.	134	3179	Fuel cell cartridges contained in equipment, containing hydrogen in metal hydride	115	3479
Flammable solid, toxic, organic, n.o.s.	134	2926	Fuel cell cartridges contained in equipment, containing liquefied flammable gas	115	3478
Fluorine, compressed	124	1045	Fuel cell cartridges contained in equipment, containing water-reactive substances	138	3476
Fluoroacetic acid	154	2642	Fuel cell cartridges, containing corrosive substances	153	3477
Fluoroanilines	153	2941	Fuel cell cartridges, containing flammable liquids	128	3473
Fluorobenzene	130	2387	Fuel cell cartridges, containing hydrogen in metal hydride	115	3479
Fluoroboric acid	154	1775	Fuel cell cartridges, containing liquefied flammable gas	115	3478
Fluorophosphoric acid, anhydrous	154	1776	Fuel cell cartridges, containing water-reactive substances	138	3476
Fluorosilicates, n.o.s.	151	2856	Fuel cell cartridges packed with equipment, containing corrosive substances	153	3477
Fluorosilicic acid	154	1778	Fuel cell cartridges packed with equipment, containing flammable liquids	128	3473
Fluorosulfonic acid	137	1777	Fuel cell cartridges packed with equipment, containing hydrogen in metal hydride	115	3479
Fluorosulphonic acid	137	1777	Fuel cell cartridges packed with equipment, containing liquefied flammable gas	115	3478
Fluorotoluenes	130	2388	Fuel cell cartridges, containing water-reactive substances	138	3476
Formaldehyde, solution (corrosive)	153	2209	Fuel cell cartridges packed with equipment, containing corrosive substances	153	3477
Formaldehyde, solution, flammable	132	1198	Fuel cell cartridges packed with equipment, containing flammable liquids	128	3473
Formalin (corrosive)	153	2209	Fuel cell cartridges packed with equipment, containing hydrogen in metal hydride	115	3479
Formalin (flammable)	132	1198	Fuel cell cartridges packed with equipment, containing liquefied flammable gas	115	3478
Formic acid	153	1779			
Formic acid, with more than 85% acid	153	1779			
Formic acid, with not less than 5% but less than 10% acid	153	3412			

Name of Material	Guide No.	ID No.	Name of Material	Guide No.	ID No.
Fuel cell cartridges packed with equipment, containing water-reactive substances	138	3476	Gas sample, non-pressurized, toxic, n.o.s., not refrigerated liquid	123	3169
Fuel oil	128	1993	Genetically modified micro-organisms	171	3245
Fumaryl chloride	156	1780	Genetically modified organisms	171	3245
Fumigated cargo transport unit	171	3359	Germane	119	2192
Furaldehydes	153P	1199	Germane, adsorbed	173	3523
Furan	128	2389	Glycerol alpha-monochlorohydrin	153	2689
Furfuryl alcohol	153	2874	Glycidaldehyde	131P	2622
Furfurylamine	132	2526	Guanidine nitrate	143	1467
Fusee (railway or highway)	133	1325	Hafnium powder, dry	135	2545
Fusel oil	127	1201	Hafnium powder, wetted with not less than 25% water	170	1326
Gallium	172	2803	Halogenated monomethyldiphenylmethanes, liquid	171	3151
Gallium contained in manufactured articles	172	3554	Halogenated monomethyldiphenylmethanes, solid	171	3152
Gas, refrigerated liquid, flammable, n.o.s.	115	3312	Hay, wet, damp or contaminated with oil	133	1327
Gas, refrigerated liquid, n.o.s.	120	3158	Hazardous waste, liquid, n.o.s.	171	3082
Gas, refrigerated liquid, oxidizing, n.o.s.	122	3311	Hazardous waste, solid, n.o.s.	171	3077
Gas cartridges	115	2037	Heating oil, light	128	1202
Gas identification set	123	9035	Helium, compressed	120	1046
Gas oil	128	1202	Helium, refrigerated liquid (cryogenic liquid)	120	1963
Gasoline	128	1203	Heptafluoropropane	126	3296
Gas sample, non-pressurized, flammable, n.o.s., not refrigerated liquid	115	3167	n-Heptaldehyde	129	3056
Gas sample, non-pressurized, poisonous, flammable, n.o.s., not refrigerated liquid	119	3168	Heptanes	128	1206
Gas sample, non-pressurized, poisonous, n.o.s., not refrigerated liquid	123	3169	n-Heptene	128	2278
Gas sample, non-pressurized, toxic, flammable, n.o.s., not refrigerated liquid	119	3168	Hexachloroacetone	153	2661
			Hexachlorobenzene	152	2729
			Hexachlorobutadiene	151	2279
			Hexachlorocyclopentadiene	151	2646

Name of Material	Guide No.	ID No.	Name of Material	Guide No.	ID No.
Hexachlorophene	151	2875	Hydrazine, aqueous solution, with not more than 37% hydrazine	153	3293
Hexadecyltrichlorosilane	156	1781	Hydriodic acid	154	1787
Hexadiene	130	2458	Hydrobromic acid	154	1788
Hexaethyl tetraphosphate	151	1611	Hydrocarbon gas mixture, compressed, n.o.s.	115	1964
Hexaethyl tetraphosphate and compressed gas mixture	123	1612	Hydrocarbon gas mixture, liquefied, n.o.s.	115	1965
Hexafluoroacetone	125	2420	Hydrocarbon gas refills for small devices, with release device	115	3150
Hexafluoroacetone hydrate, liquid	151	2552	Hydrocarbons, liquid, n.o.s.	128	3295
Hexafluoroacetone hydrate, solid	151	3436	Hydrochloric acid	157	1789
Hexafluoroethane	126	2193	Hydrocyanic acid, aqueous solution, with less than 5% hydrogen cyanide	154	1613
Hexafluorophosphoric acid	154	1782	Hydrocyanic acid, aqueous solution, with not more than 20% hydrogen cyanide	154	1613
Hexafluoropropylene	126	1858	Hydrofluoric acid	157	1790
Hexafluoropropylene, compressed	126	1858	Hydrofluoric acid and sulfuric acid mixture	157	1786
Hexaldehyde	130	1207	Hydrofluoric acid and sulphuric acid mixture	157	1786
Hexamethylenediamine, solid	153	2280	Hydrofluorosilicic acid	154	1778
Hexamethylenediamine, solution	153	1783	Hydrogen, compressed	115	1049
Hexamethylene diisocyanate	156	2281	Hydrogen in a metal hydride storage system	115	3468
Hexamethyleneimine	132	2493	Hydrogen in a metal hydride storage system contained in equipment	115	3468
Hexamethylenetetramine	133	1328	Hydrogen in a metal hydride storage system packed with equipment	115	3468
Hexanes	128	1208	Hydrogen, refrigerated liquid (cryogenic liquid)	115	1966
Hexanoic acid	153	2829	Hydrogen and methane mixture, compressed	115	2034
Hexanols	129	2282	Hydrogen bromide, anhydrous	125	1048
1-Hexene	128	2370			
Hexyltrichlorosilane	156	1784			
Hydrazine, anhydrous	132	2029			
Hydrazine aqueous solution, flammable, with more than 37% hydrazine	132	3484			
Hydrazine, aqueous solution, with more than 37% hydrazine	153	2030			

Name of Material	Guide No.	ID No.	Name of Material	Guide No.	ID No.
Hydrogen chloride, anhydrous	125	1050	1-Hydroxybenzotriazole, monohydrate	113	3474
Hydrogen chloride, refrigerated liquid	125	2186	Hydroxylamine sulfate	154	2865
Hydrogen cyanide, aqueous solution, with not more than 20% hydrogen cyanide	154	1613	Hydroxylamine sulphate	154	2865
Hydrogen cyanide, solution in alcohol, with not more than 45% hydrogen cyanide	131	3294	Hypochlorite solution	154	1791
Hydrogen cyanide, stabilized	117P	1051	Hypochlorites, inorganic, n.o.s.	140	3212
Hydrogen cyanide, stabilized (absorbed)	152	1614	3,3'-Iminodipropylamine	153	2269
Hydrogendifluorides, solid, n.o.s.	154	1740	Infectious substance, affecting animals only	158	2900
Hydrogendifluorides, solution, n.o.s.	154	3471	Infectious substance, affecting humans	158	2814
Hydrogen fluoride, anhydrous	125	1052	Insecticide gas, flammable, n.o.s.	115	3354
Hydrogen iodide, anhydrous	125	2197	Insecticide gas, n.o.s.	126	1968
Hydrogen peroxide, aqueous solution, stabilized, with more than 60% hydrogen peroxide	143	2015	Insecticide gas, poisonous, flammable, n.o.s.	119	3355
Hydrogen peroxide, aqueous solution, with not less than 8% but less than 20% hydrogen peroxide	140	2984	Insecticide gas, poisonous, flammable, n.o.s. (Inhalation Hazard Zone A)	119	3355
Hydrogen peroxide, aqueous solution, with not less than 20% but not more than 60% hydrogen peroxide (stabilized as necessary)	140	2014	Insecticide gas, poisonous, flammable, n.o.s. (Inhalation Hazard Zone B)	119	3355
Hydrogen peroxide, stabilized	143	2015	Insecticide gas, poisonous, flammable, n.o.s. (Inhalation Hazard Zone C)	119	3355
Hydrogen peroxide and peroxyacetic acid mixture, with acid(s), water and not more than 5% peroxyacetic acid, stabilized	140	3149	Insecticide gas, poisonous, n.o.s.	123	1967
Hydrogen selenide, adsorbed	173	3526	Insecticide gas, poisonous, flammable, n.o.s. (Inhalation Hazard Zone D)	119	3355
Hydrogen selenide, anhydrous	117	2202	Insecticide gas, toxic, flammable, n.o.s.	119	3355
Hydrogen sulfide	117	1053	Insecticide gas, toxic, flammable, n.o.s. (Inhalation Hazard Zone A)	119	3355
Hydrogen sulphide	117	1053	Insecticide gas, toxic, flammable, n.o.s. (Inhalation Hazard Zone B)	119	3355
			Insecticide gas, toxic, flammable, n.o.s. (Inhalation Hazard Zone C)	119	3355

Name of Material	Guide No.	ID No.	Name of Material	Guide No.	ID No.
Insecticide gas, toxic, flammable, n.o.s. (Inhalation Hazard Zone D)	119	3355	Isobutryl chloride	155	2395
Insecticide gas, toxic, n.o.s.	123	1967	Isocyanate solution, flammable, poisonous, n.o.s.	155	2478
Iodine	154	3495	Isocyanate solution, flammable, toxic, n.o.s.	155	2478
Iodine monochloride, liquid	157	3498	Isocyanate solution, poisonous, flammable, n.o.s.	155	3080
Iodine monochloride, solid	157	1792	Isocyanate solution, poisonous, n.o.s.	156	2206
Iodine pentafluoride	144	2495	Isocyanate solution, toxic, flammable, n.o.s.	155	3080
2-Iodobutane	129	2390	Isocyanate solution, toxic, n.o.s.	156	2206
Iodomethylpropanes	129	2391	Isocyanates, flammable, poisonous, n.o.s.	155	2478
Iodopropanes	129	2392	Isocyanates, flammable, toxic, n.o.s.	155	2478
Iron oxide, spent	135	1376	Isocyanates, poisonous, flammable, n.o.s.	155	3080
Iron pentacarbonyl	136	1994	Isocyanates, poisonous, n.o.s.	156	2206
Iron sponge, spent	135	1376	Isocyanates, toxic, flammable, n.o.s.	155	3080
Isobutane	115	1075	Isocyanates, toxic, n.o.s.	156	2206
Isobutane	115	1969	Isocyanatobenzotrifluorides	155	2285
Isobutanol	129	1212	Isoheptenes	128	2287
Isobutyl acetate	129	1213	Isohexenes	128	2288
Isobutyl acrylate, stabilized	129P	2527	Isooctane	128	1262
Isobutyl alcohol	129	1212	Isooctenes	128	1216
Isobutyl aldehyde	130	2045	Isopentane	128	1265
Isobutylamine	132	1214	Isopentenes	128	2371
Isobutylene	115	1055	Isophoronediamine	153	2289
Isobutylene	115	1075	Isophorone diisocyanate	156	2290
Isobutyl formate	129	2393	Isoprene, stabilized	130P	1218
Isobutyl isobutyrate	130	2528	Isopropanol	129	1219
Isobutyl isocyanate	155P	2486	Isopropenyl acetate	129P	2403
Isobutyl methacrylate, stabilized	130P	2283	Isopropenylbenzene	128	2303
Isobutyl propionate	129	2394			
Isobutyraldehyde	130	2045			
Isobutyric acid	132	2529			
Isobutyronitrile	131	2284			

Name of Material	Guide No.	ID No.	Name of Material	Guide No.	ID No.
Isopropyl acetate	129	1220	Lead sulphate, with more than 3% free acid	154	1794
Isopropyl acid phosphate	153	1793	Life-saving appliances, not self-inflating	171	3072
Isopropyl alcohol	129	1219	Life-saving appliances, self-inflating	171	2990
Isopropylamine	132	1221	Lighter refills containing flammable gas	115	1057
Isopropylbenzene	130	1918	Lighters containing flammable gas	115	1057
Isopropyl butyrate	129	2405	Lighters, non-pressurized, containing flammable liquid	128	1057
Isopropyl chloroacetate	127	2947	Liquefied gas, flammable, n.o.s.	115	3161
Isopropyl chloroformate	155	2407	Liquefied gas, n.o.s.	126	3163
Isopropyl 2-chloropropionate	129	2934	Liquefied gas, oxidizing, n.o.s.	122	3157
Isopropyl isobutyrate	127	2406	Liquefied gas, poisonous, corrosive, n.o.s.	125	3308
Isopropyl isocyanate	155P	2483	Liquefied gas, poisonous, corrosive, n.o.s. (Inhalation Hazard Zone A)	125	3308
Isopropyl nitrate	130	1222	Liquefied gas, poisonous, corrosive, n.o.s. (Inhalation Hazard Zone B)	125	3308
Isopropyl propionate	129	2409	Liquefied gas, poisonous, corrosive, n.o.s. (Inhalation Hazard Zone C)	125	3308
Isosorbide dinitrate mixture	133	2907	Liquefied gas, poisonous, corrosive, n.o.s. (Inhalation Hazard Zone D)	125	3308
Isosorbide-5-mononitrate	133	3251	Liquefied gas, poisonous, flammable, corrosive, n.o.s.	119	3309
Kerosene	128	1223	Liquefied gas, poisonous, flammable, corrosive, n.o.s. (Inhalation Hazard Zone A)	119	3309
Ketones, liquid, n.o.s.	127	1224	Liquefied gas, poisonous, flammable, corrosive, n.o.s. (Inhalation Hazard Zone B)	119	3309
Krill meal	133	3497	Liquefied gas, poisonous, flammable, corrosive, n.o.s. (Inhalation Hazard Zone C)	119	3309
Krypton, compressed	120	1056	Liquefied gas, poisonous, flammable, corrosive, n.o.s. (Inhalation Hazard Zone C)	119	3309
Krypton, refrigerated liquid (cryogenic liquid)	120	1970	Liquefied gas, poisonous, flammable, corrosive, n.o.s. (Inhalation Hazard Zone C)	119	3309
Lead acetate	151	1616	Liquefied gas, poisonous, flammable, corrosive, n.o.s. (Inhalation Hazard Zone C)	119	3309
Lead arsenates	151	1617	Liquefied gas, poisonous, flammable, corrosive, n.o.s. (Inhalation Hazard Zone C)	119	3309
Lead arsenites	151	1618	Liquefied gas, poisonous, flammable, corrosive, n.o.s. (Inhalation Hazard Zone C)	119	3309
Lead compound, soluble, n.o.s.	151	2291	Liquefied gas, poisonous, flammable, corrosive, n.o.s. (Inhalation Hazard Zone C)	119	3309
Lead cyanide	151	1620	Liquefied gas, poisonous, flammable, corrosive, n.o.s. (Inhalation Hazard Zone C)	119	3309
Lead dioxide	140	1872	Liquefied gas, poisonous, flammable, corrosive, n.o.s. (Inhalation Hazard Zone C)	119	3309
Lead nitrate	141	1469	Liquefied gas, poisonous, flammable, corrosive, n.o.s. (Inhalation Hazard Zone C)	119	3309
Lead perchlorate, solid	141	1470	Liquefied gas, poisonous, flammable, corrosive, n.o.s. (Inhalation Hazard Zone C)	119	3309
Lead perchlorate, solution	141	3408	Liquefied gas, poisonous, flammable, corrosive, n.o.s. (Inhalation Hazard Zone C)	119	3309
Lead phosphite, dibasic	133	2989	Liquefied gas, poisonous, flammable, corrosive, n.o.s. (Inhalation Hazard Zone C)	119	3309
Lead sulfate, with more than 3% free acid	154	1794	Liquefied gas, poisonous, flammable, corrosive, n.o.s. (Inhalation Hazard Zone C)	119	3309

Name of Material	Guide No.	ID No.	Name of Material	Guide No.	ID No.
Liquefied gas, poisonous, flammable, corrosive, n.o.s. (Inhalation Hazard Zone D)	119	3309	Liquefied gas, poisonous, oxidizing, corrosive, n.o.s. (Inhalation Hazard Zone D)	124	3310
Liquefied gas, poisonous, flammable, n.o.s.	119	3160	Liquefied gas, poisonous, oxidizing, n.o.s.	124	3307
Liquefied gas, poisonous, flammable, n.o.s. (Inhalation Hazard Zone A)	119	3160	Liquefied gas, poisonous, oxidizing, n.o.s. (Inhalation Hazard Zone A)	124	3307
Liquefied gas, poisonous, flammable, n.o.s. (Inhalation Hazard Zone B)	119	3160	Liquefied gas, poisonous, oxidizing, n.o.s. (Inhalation Hazard Zone B)	124	3307
Liquefied gas, poisonous, flammable, n.o.s. (Inhalation Hazard Zone C)	119	3160	Liquefied gas, poisonous, oxidizing, n.o.s. (Inhalation Hazard Zone C)	124	3307
Liquefied gas, poisonous, flammable, n.o.s. (Inhalation Hazard Zone D)	119	3160	Liquefied gas, poisonous, oxidizing, n.o.s. (Inhalation Hazard Zone D)	124	3307
Liquefied gas, poisonous, n.o.s.	123	3162	Liquefied gas, toxic, corrosive, n.o.s.	125	3308
Liquefied gas, poisonous, n.o.s. (Inhalation Hazard Zone A)	123	3162	Liquefied gas, toxic, corrosive, n.o.s. (Inhalation Hazard Zone A)	125	3308
Liquefied gas, poisonous, n.o.s. (Inhalation Hazard Zone B)	123	3162	Liquefied gas, toxic, corrosive, n.o.s. (Inhalation Hazard Zone B)	125	3308
Liquefied gas, poisonous, n.o.s. (Inhalation Hazard Zone C)	123	3162	Liquefied gas, toxic, corrosive, n.o.s. (Inhalation Hazard Zone C)	125	3308
Liquefied gas, poisonous, n.o.s. (Inhalation Hazard Zone D)	123	3162	Liquefied gas, toxic, corrosive, n.o.s. (Inhalation Hazard Zone D)	125	3308
Liquefied gas, poisonous, oxidizing, corrosive, n.o.s.	124	3310	Liquefied gas, toxic, flammable, corrosive, n.o.s.	119	3309
Liquefied gas, poisonous, oxidizing, corrosive, n.o.s. (Inhalation Hazard Zone A)	124	3310	Liquefied gas, toxic, flammable, corrosive, n.o.s. (Inhalation Hazard Zone A)	119	3309
Liquefied gas, poisonous, oxidizing, corrosive, n.o.s. (Inhalation Hazard Zone B)	124	3310	Liquefied gas, toxic, flammable, corrosive, n.o.s. (Inhalation Hazard Zone B)	119	3309
Liquefied gas, poisonous, oxidizing, corrosive, n.o.s. (Inhalation Hazard Zone C)	124	3310	Liquefied gas, toxic, flammable, corrosive, n.o.s. (Inhalation Hazard Zone C)	119	3309

Name of Material	Guide No.	ID No.	Name of Material	Guide No.	ID No.
Liquefied gas, toxic, flammable, corrosive, n.o.s. (Inhalation Hazard Zone D)	119	3309	Liquefied gas, toxic, oxidizing, n.o.s. (Inhalation Hazard Zone A)	124	3307
Liquefied gas, toxic, flammable, n.o.s.	119	3160	Liquefied gas, toxic, oxidizing, n.o.s. (Inhalation Hazard Zone B)	124	3307
Liquefied gas, toxic, flammable, n.o.s. (Inhalation Hazard Zone A)	119	3160	Liquefied gas, toxic, oxidizing, n.o.s. (Inhalation Hazard Zone C)	124	3307
Liquefied gas, toxic, flammable, n.o.s. (Inhalation Hazard Zone B)	119	3160	Liquefied gas, toxic, oxidizing, n.o.s. (Inhalation Hazard Zone D)	124	3307
Liquefied gas, toxic, flammable, n.o.s. (Inhalation Hazard Zone C)	119	3160	Liquefied gases, non-flammable, charged with nitrogen, carbon dioxide or air	120	1058
Liquefied gas, toxic, flammable, n.o.s. (Inhalation Hazard Zone D)	119	3160	Liquefied natural gas (cryogenic liquid)	115	1972
Liquefied gas, toxic, n.o.s.	123	3162	Liquefied petroleum gas	115	1075
Liquefied gas, toxic, n.o.s. (Inhalation Hazard Zone A)	123	3162	Lithium	138	1415
Liquefied gas, toxic, n.o.s. (Inhalation Hazard Zone B)	123	3162	Lithium aluminum hydride	138	1410
Liquefied gas, toxic, n.o.s. (Inhalation Hazard Zone C)	123	3162	Lithium aluminum hydride, ethereal	138	1411
Liquefied gas, toxic, n.o.s. (Inhalation Hazard Zone D)	123	3162	Lithium batteries installed in cargo transport unit (lithium ion batteries)	147	3536
Liquefied gas, toxic, oxidizing, corrosive, n.o.s.	124	3310	Lithium batteries installed in cargo transport unit (lithium metal batteries)	138	3536
Liquefied gas, toxic, oxidizing, corrosive, n.o.s. (Inhalation Hazard Zone A)	124	3310	Lithium borohydride	138	1413
Liquefied gas, toxic, oxidizing, corrosive, n.o.s. (Inhalation Hazard Zone B)	124	3310	Lithium ferrosilicon	139	2830
Liquefied gas, toxic, oxidizing, corrosive, n.o.s. (Inhalation Hazard Zone C)	124	3310	Lithium hydride	138	1414
Liquefied gas, toxic, oxidizing, corrosive, n.o.s. (Inhalation Hazard Zone D)	124	3310	Lithium hydride, fused solid	138	2805
Liquefied gas, toxic, oxidizing, n.o.s.	124	3307	Lithium hydroxide	154	2680
			Lithium hydroxide, solution	154	2679
			Lithium hypochlorite, dry	140	1471
			Lithium hypochlorite mixture	140	1471
			Lithium ion batteries (including lithium ion polymer batteries)	147	3480

Name of Material	Guide No.	ID No.	Name of Material	Guide No.	ID No.
Lithium ion batteries contained in equipment (including lithium ion polymer batteries)	147	3481	Magnesium alloys, with more than 50% magnesium, in pellets, turnings or ribbons	138	1869
Lithium ion batteries packed with equipment (including lithium ion polymer batteries)	147	3481	Magnesium alloys powder	138	1418
Lithium metal batteries (including lithium alloy batteries)	138	3090	Magnesium aluminum phosphide	139	1419
Lithium metal batteries contained in equipment (including lithium alloy batteries)	138	3091	Magnesium arsenate	151	1622
Lithium metal batteries packed with equipment (including lithium alloy batteries)	138	3091	Magnesium bromate	140	1473
Lithium nitrate	140	2722	Magnesium chlorate	140	2723
Lithium nitride	139	2806	Magnesium diamide	135	2004
Lithium peroxide	143	1472	Magnesium fluorosilicate	151	2853
Lithium silicon	138	1417	Magnesium granules, coated	138	2950
LNG (cryogenic liquid)	115	1972	Magnesium hydride	138	2010
London purple	151	1621	Magnesium nitrate	140	1474
LPG	115	1075	Magnesium perchlorate	140	1475
Machinery, fuel cell, flammable gas powered	115	3529	Magnesium peroxide	140	1476
Machinery, fuel cell, flammable liquid powered	128	3528	Magnesium phosphide	139	2011
Machinery, internal combustion	171	3530	Magnesium powder	138	1418
Machinery, internal combustion, flammable gas powered	115	3529	Magnesium silicide	138	2624
Machinery, internal combustion, flammable liquid powered	128	3528	Magnetized material	171	2807
Magnesium	138	1869	Maleic anhydride	156	2215
Magnesium, in pellets, turnings or ribbons	138	1869	Maleic anhydride, molten	156	2215
			Malononitrile	153	2647
			Maneb	135	2210
			Maneb, stabilized	135	2968
			Maneb preparation, stabilized	135	2968
			Maneb preparation, with not less than 60% maneb	135	2210
			Manganese nitrate	140	2724
			Manganese resinate	133	1330
			Matches, fusee	133	2254
			Matches, safety	133	1944
			Matches, "strike anywhere"	133	1331
			Matches, wax "vesta"	133	1945

Name of Material	Guide No.	ID No.	Name of Material	Guide No.	ID No.
Medical waste, category A, affecting animals only, solid	158	3549	Mercurous nitrate	141	1627
Medical waste, category A, affecting humans, solid	158	3549	Mercury	172	2809
Medical waste, n.o.s.	158	3291	Mercury acetate	151	1629
Medicine, liquid, flammable, poisonous, n.o.s.	131	3248	Mercury ammonium chloride	151	1630
Medicine, liquid, flammable, toxic, n.o.s.	131	3248	Mercury based pesticide, liquid, flammable, poisonous	131	2778
Medicine, liquid, poisonous, n.o.s.	151	1851	Mercury based pesticide, liquid, flammable, toxic	131	2778
Medicine, liquid, toxic, n.o.s.	151	1851	Mercury based pesticide, liquid, poisonous	151	3012
Medicine, solid, poisonous, n.o.s.	151	3249	Mercury based pesticide, liquid, poisonous, flammable	131	3011
Medicine, solid, toxic, n.o.s.	151	3249	Mercury based pesticide, liquid, toxic	151	3012
Mercaptan mixture, liquid, flammable, n.o.s.	130	3336	Mercury based pesticide, liquid, toxic, flammable	131	3011
Mercaptan mixture, liquid, flammable, poisonous, n.o.s.	131	1228	Mercury based pesticide, solid, poisonous	151	2777
Mercaptan mixture, liquid, flammable, toxic, n.o.s.	131	1228	Mercury based pesticide, solid, toxic	151	2777
Mercaptan mixture, liquid, poisonous, flammable, n.o.s.	131	3071	Mercury benzoate	154	1631
Mercaptan mixture, liquid, toxic, flammable, n.o.s.	131	3071	Mercury bromides	154	1634
Mercaptans, liquid, flammable, n.o.s.	130	3336	Mercury compound, liquid, n.o.s.	151	2024
Mercaptans, liquid, flammable, poisonous, n.o.s.	131	1228	Mercury compound, solid, n.o.s.	151	2025
Mercaptans, liquid, flammable, toxic, n.o.s.	131	1228	Mercury contained in manufactured articles	172	3506
Mercaptans, liquid, poisonous, flammable, n.o.s.	131	3071	Mercury cyanide	154	1636
Mercaptans, liquid, toxic, flammable, n.o.s.	131	3071	Mercury gluconate	151	1637
Mercuric arsenate	151	1623	Mercury iodide	151	1638
Mercuric chloride	154	1624	Mercury nucleate	151	1639
Mercuric nitrate	141	1625	Mercury oleate	151	1640
Mercuric potassium cyanide	157	1626	Mercury oxide	151	1641
			Mercury oxycyanide, desensitized	151	1642
			Mercury potassium iodide	151	1643

Name of Material	Guide No.	ID No.	Name of Material	Guide No.	ID No.
Mercury salicylate	151	1644	4-Methoxy-4-methylpentan-2-one	128	2293
Mercury sulfate	151	1645	1-Methoxy-2-propanol	129	3092
Mercury sulphate	151	1645	Methyl acetate	129	1231
Mercury thiocyanate	151	1646	Methylacetylene and propadiene mixture, stabilized	116P	1060
Mesityl oxide	129	1229	Methyl acrylate, stabilized	129P	1919
Metal carbonyls, liquid, n.o.s.	151	3281	Methylal	127	1234
Metal carbonyls, solid, n.o.s.	151	3466	Methyl alcohol	131	1230
Metal catalyst, dry	135	2881	Methylallyl chloride	130P	2554
Metal catalyst, wetted	170	1378	Methylamine, anhydrous	118	1061
Metaldehyde	133	1332	Methylamine, aqueous solution	132	1235
Metal hydrides, flammable, n.o.s.	170	3182	Methylamyl acetate	130	1233
Metal hydrides, water-reactive, n.o.s.	138	1409	Methyl amyl ketone	127	1110
Metallic substance, water-reactive, n.o.s.	138	3208	N-Methylaniline	153	2294
Metallic substance, water-reactive, self-heating, n.o.s.	138	3209	Methylbenzyl (alpha) alcohol, liquid	153	2937
Metal powder, flammable, n.o.s.	170	3089	Methylbenzyl (alpha) alcohol, solid	153	3438
Metal powder, self-heating, n.o.s.	135	3189	Methyl bromide	123	1062
Metal salts of organic compounds, flammable, n.o.s.	133	3181	Methyl bromide and ethylene dibromide mixture, liquid	151	1647
Methacrylaldehyde, stabilized	131P	2396	Methyl bromoacetate	153	2643
Methacrylic acid, stabilized	153P	2531	2-Methylbutanal	129	3371
Methacrylonitrile, stabilized	131P	3079	3-Methylbutan-2-one	127	2397
Methallyl alcohol	129	2614	2-Methyl-1-butene	128	2459
Methane, compressed	115	1971	2-Methyl-2-butene	128	2460
Methane, refrigerated liquid (cryogenic liquid)	115	1972	3-Methyl-1-butene	128	2561
Methanesulfonyl chloride	156	3246	N-Methylbutylamine	132	2945
Methanesulphonyl chloride	156	3246	Methyl tert-butyl ether	127	2398
Methanol	131	1230	Methyl butyrate	129	1237
Methoxymethyl isocyanate	155	2605	Methyl chloride	115	1063
			Methyl chloride and methylene chloride mixture	115	1912

Name of Material	Guide No.	ID No.	Name of Material	Guide No.	ID No.
Methyl chloroacetate	131	2295	Methyl methacrylate monomer, stabilized	129P	1247
Methyl chloroformate	155	1238	4-Methylmorpholine	132	2535
Methyl chloromethyl ether	131	1239	N-Methylmorpholine	132	2535
Methyl 2-chloropropionate	129	2933	Methyl nitrite	116	2455
Methylchlorosilane	119	2534	Methyl orthosilicate	155	2606
Methylcyclohexane	128	2296	Methylpentadiene	128	2461
Methylcyclohexanols	129	2617	2-Methylpentan-2-ol	129	2560
Methylcyclohexanone	128	2297	Methylphenyldichlorosilane	156	2437
Methylcyclopentane	128	2298	Methyl phosphonic dichloride	137	9206
Methyl dichloroacetate	156	2299	Methyl phosphonous dichloride	135	2845
Methyldichloroarsine	152	1556	1-Methylpiperidine	132	2399
Methyldichlorosilane	139	1242	Methyl propionate	129	1248
Methylene chloride	160	1593	Methyl propyl ether	127	2612
Methyl ethyl ether	115	1039	Methyl propyl ketone	127	1249
Methyl ethyl ketone	127	1193	Methyltetrahydrofuran	127	2536
2-Methyl-5-ethylpyridine	153	2300	Methyl trichloroacetate	156	2533
Methyl fluoride	115	2454	Methyltrichlorosilane	155	1250
Methyl formate	129	1243	Methyl valeraldehyde (alpha)	130	2367
2-Methylfuran	128	2301	Methyl vinyl ketone, stabilized	131P	1251
2-Methyl-2-heptanethiol	131	3023	Molten sulfur	133	2448
5-Methylhexan-2-one	127	2302	Molten sulphur	133	2448
Methylhydrazine	131	1244	Molybdenum pentachloride	156	2508
Methyl iodide	151	2644	Monoethanolamine	153	2491
Methyl isobutyl carbinol	129	2053	Mononitrotoluidines	153	2660
Methyl isobutyl ketone	127	1245	Morpholine	132	2054
Methyl isocyanate	155P	2480	Motor fuel anti-knock mixture	152	1649
Methyl isopropenyl ketone, stabilized	127P	1246	Motor fuel anti-knock mixture, flammable	131	3483
Methyl isothiocyanate	131	2477	Motor spirit	128	1203
Methyl isovalerate	130	2400	Muriatic acid	157	1789
Methyl magnesium bromide in ethyl ether	138	1928	Musk xylene	149	2956
Methyl mercaptan	117	1064	Naphthalene, crude	133	1334

Name of Material	Guide No.	ID No.	Name of Material	Guide No.	ID No.
Naphthalene, molten	133	2304	Nicotine sulphate, solid	151	3445
Naphthalene, refined	133	1334	Nicotine sulphate, solution	151	1658
Naphthylamine (alpha)	153	2077	Nicotine tartrate	151	1659
Naphthylamine (beta), solid	153	1650	Nitrates, inorganic, aqueous solution, n.o.s.	140	3218
Naphthylamine (beta), solution	153	3411	Nitrates, inorganic, n.o.s.	140	1477
Naphthylthiourea	153	1651	Nitrating acid mixture with more than 50% nitric acid	157	1796
Naphthylurea	153	1652	Nitrating acid mixture with not more than 50% nitric acid	157	1796
Natural gas, compressed	115	1971	Nitrating acid mixture, spent, with more than 50% nitric acid	157	1826
Natural gas, refrigerated liquid (cryogenic liquid)	115	1972	Nitrating acid mixture, spent, with not more than 50% nitric acid	157	1826
Neohexane	128	1208	Nitric acid, other than red fuming, with more than 65% nitric acid	157	2031
Neon, compressed	120	1065	Nitric acid, other than red fuming, with not more than 65% nitric acid	157	2031
Neon, refrigerated liquid (cryogenic liquid)	120	1913	Nitric acid, red fuming	157	2032
Nickel carbonyl	131	1259	Nitric oxide, compressed	124	1660
Nickel catalyst, dry	135	2881	Nitric oxide and dinitrogen tetroxide mixture	124	1975
Nickel cyanide	151	1653	Nitric oxide and nitrogen dioxide mixture	124	1975
Nickel nitrate	140	2725	Nitriles, flammable, poisonous, n.o.s.	131	3273
Nickel nitrite	140	2726	Nitriles, flammable, toxic, n.o.s.	131	3273
Nicotine	151	1654	Nitriles, liquid, poisonous, n.o.s.	151	3276
Nicotine compound, liquid, n.o.s.	151	3144	Nitriles, liquid, toxic, n.o.s.	151	3276
Nicotine compound, solid, n.o.s.	151	1655	Nitriles, poisonous, flammable, n.o.s.	131	3275
Nicotine hydrochloride, liquid	151	1656	Nitriles, poisonous, liquid, n.o.s.	151	3276
Nicotine hydrochloride, solid	151	3444			
Nicotine hydrochloride, solution	151	1656			
Nicotine preparation, liquid, n.o.s.	151	3144			
Nicotine preparation, solid, n.o.s.	151	1655			
Nicotine salicylate	151	1657			
Nicotine sulfate, solid	151	3445			
Nicotine sulfate, solution	151	1658			

Name of Material	Guide No.	ID No.	Name of Material	Guide No.	ID No.
Nitriles, solid, poisonous, n.o.s.	151	3439	Nitrogen, refrigerated liquid (cryogenic liquid)	120	1977
Nitriles, solid, toxic, n.o.s.	151	3439	Nitrogen dioxide	124	1067
Nitriles, toxic, flammable, n.o.s.	131	3275	Nitrogen trifluoride	122	2451
Nitriles, toxic, liquid, n.o.s.	151	3276	Nitrogen trioxide	124	2421
Nitrites, inorganic, aqueous solution, n.o.s.	140	3219	Nitroglycerin, solution in alcohol, with more than 1% but not more than 5% nitroglycerin	127	3064
Nitrites, inorganic, n.o.s.	140	2627	Nitroglycerin, solution in alcohol, with not more than 1% nitroglycerin	127	1204
Nitroanilines	153	1661	Nitroglycerin mixture, desensitized, liquid, flammable, n.o.s., with not more than 30% nitroglycerin	113	3343
Nitroanisoles, liquid	152	2730	Nitroglycerin mixture, desensitized, liquid, n.o.s., with not more than 30% nitroglycerin	113	3357
Nitroanisoles, solid	152	3458	Nitroglycerin mixture, desensitized, solid, n.o.s., with more than 2% but not more than 10% nitroglycerin	113	3319
Nitrobenzene	152	1662	Nitroguanidine, wetted with not less than 20% water	113	1336
Nitrobenzenesulfonic acid	153	2305	Nitrohydrochloric acid	157	1798
Nitrobenzenesulphonic acid	153	2305	Nitromethane	129	1261
Nitrobenzotrifluorides, liquid	152	2306	Nitronaphthalene	133	2538
Nitrobenzotrifluorides, solid	152	3431	Nitrophenols	153	1663
Nitrobromobenzenes, liquid	152	2732	4-Nitrophenylhydrazine, with not less than 30% water	113	3376
Nitrobromobenzenes, solid	152	3459	Nitropropanes	129	2608
Nitrocellulose membrane filters	133	3270	p-Nitrosodimethylaniline	135	1369
Nitrocellulose mixture, with or without pigment	133	2557	Nitrostarch, wetted with not less than 20% water	113	1337
Nitrocellulose mixture, with or without plasticizer	133	2557	Nitrosyl chloride	125	1069
Nitrocellulose solution, flammable	127	2059	Nitrosylsulfuric acid, liquid	157	2308
Nitrocellulose with alcohol, not less than 25% alcohol	113	2556	Nitrosylsulfuric acid, solid	157	3456
Nitrocellulose with water, not less than 25% water	113	2555			
3-Nitro-4-chlorobenzotrifluoride	152	2307			
Nitrocresols, liquid	153	3434			
Nitrocresols, solid	153	2446			
Nitroethane	129	2842			
Nitrogen, compressed	120	1066			

Name of Material	Guide No.	ID No.	Name of Material	Guide No.	ID No.
Nitrosylsulphuric acid, liquid	157	2308	Organic peroxide type C, solid	146	3104
Nitrosylsulphuric acid, solid	157	3456	Organic peroxide type C, solid, temperature controlled	148	3114
Nitrotoluenes, liquid	152	1664	Organic peroxide type D, liquid	145	3105
Nitrotoluenes, solid	152	3446	Organic peroxide type D, liquid, temperature controlled	148	3115
Nitrotoluidines (mono)	153	2660	Organic peroxide type D, solid	145	3106
Nitrous oxide	122	1070	Organic peroxide type D, solid, temperature controlled	148	3116
Nitrous oxide, compressed	122	1070	Organic peroxide type E, liquid	145	3107
Nitrous oxide, refrigerated liquid	122	2201	Organic peroxide type E, liquid, temperature controlled	148	3117
Nitroxylenes, liquid	152	1665	Organic peroxide type E, solid	145	3108
Nitroxylenes, solid	152	3447	Organic peroxide type E, solid, temperature controlled	148	3118
Nonanes	128	1920	Organic peroxide type F, liquid	145	3109
Nonyltrichlorosilane	156	1799	Organic peroxide type F, liquid, temperature controlled	148	3119
2,5-Norbornadiene, stabilized	128P	2251	Organic peroxide type F, solid	145	3110
Octadecyltrichlorosilane	156	1800	Organic peroxide type F, solid, temperature controlled	148	3120
Octadiene	128P	2309	Organic phosphate compound mixed with compressed gas	123	1955
Octafluorobut-2-ene	126	2422	Organic phosphate mixed with compressed gas	123	1955
Octafluorocyclobutane	126	1976	Organic phosphorus compound mixed with compressed gas	123	1955
Octafluoropropane	126	2424	Organic pigments, self-heating	135	3313
Octanes	128	1262	Organoarsenic compound, liquid, n.o.s.	151	3280
Octyl aldehydes	129	1191	Organoarsenic compound, solid, n.o.s.	151	3465
Octyltrichlorosilane	156	1801	Organochlorine pesticide, liquid, flammable, poisonous	131	2762
Oil gas, compressed	119	1071	Organochlorine pesticide, liquid, flammable, toxic	131	2762
Organic peroxide type B, liquid	146	3101			
Organic peroxide type B, liquid, temperature controlled	148	3111			
Organic peroxide type B, solid	146	3102			
Organic peroxide type B, solid, temperature controlled	148	3112			
Organic peroxide type C, liquid	146	3103			
Organic peroxide type C, liquid, temperature controlled	148	3113			

Name of Material	Guide No.	ID No.	Name of Material	Guide No.	ID No.
Organochlorine pesticide, liquid, poisonous	151	2996	Organometallic substance, solid, water-reactive, flammable	138	3396
Organochlorine pesticide, liquid, poisonous, flammable	131	2995	Organometallic substance, solid, water-reactive, self-heating	138	3397
Organochlorine pesticide, liquid, toxic	151	2996	Organophosphorus compound, liquid, poisonous, n.o.s.	151	3278
Organochlorine pesticide, liquid, toxic, flammable	131	2995	Organophosphorus compound, liquid, toxic, n.o.s.	151	3278
Organochlorine pesticide, solid, poisonous	151	2761	Organophosphorus compound, poisonous, flammable, n.o.s.	131	3279
Organochlorine pesticide, solid, toxic	151	2761	Organophosphorus compound, solid, poisonous, n.o.s.	151	3464
Organometallic compound, liquid, poisonous, n.o.s.	151	3282	Organophosphorus compound, solid, toxic, n.o.s.	151	3464
Organometallic compound, liquid, toxic, n.o.s.	151	3282	Organophosphorus compound, toxic, flammable, n.o.s.	131	3279
Organometallic compound, solid, poisonous, n.o.s.	151	3467	Organophosphorus pesticide, liquid, flammable, poisonous	131	2784
Organometallic compound, solid, toxic, n.o.s.	151	3467	Organophosphorus pesticide, liquid, flammable, toxic	131	2784
Organometallic substance, liquid, pyrophoric	135	3392	Organophosphorus pesticide, liquid, poisonous	152	3018
Organometallic substance, liquid, pyrophoric, water-reactive	135	3394	Organophosphorus pesticide, liquid, poisonous, flammable	131	3017
Organometallic substance, liquid, water-reactive	135	3398	Organophosphorus pesticide, liquid, toxic	152	3018
Organometallic substance, liquid, water-reactive, flammable	138	3399	Organophosphorus pesticide, liquid, toxic, flammable	131	3017
Organometallic substance, solid, pyrophoric	135	3391	Organophosphorus pesticide, solid, poisonous	152	2783
Organometallic substance, solid, pyrophoric, water-reactive	135	3393	Organophosphorus pesticide, solid, toxic	152	2783
Organometallic substance, solid, self-heating	138	3400	Organotin compound, liquid, n.o.s.	153	2788
Organometallic substance, solid, water-reactive	135	3395	Organotin compound, solid, n.o.s.	153	3146
			Organotin pesticide, liquid, flammable, poisonous	131	2787

Name of Material	Guide No.	ID No.	Name of Material	Guide No.	ID No.
Organotin pesticide, liquid, flammable, toxic	131	2787	Oxygen, refrigerated liquid (cryogenic liquid)	122	1073
Organotin pesticide, liquid, poisonous	153	3020	Oxygen difluoride, compressed	124	2190
Organotin pesticide, liquid, poisonous, flammable	131	3019	Oxygen generator, chemical	140	3356
Organotin pesticide, liquid, toxic	153	3020	Oxygen generator, chemical, spent	140	3356
Organotin pesticide, liquid, toxic, flammable	131	3019	Packagings discarded, empty, uncleaned	171	3509
Organotin pesticide, solid, poisonous	153	2786	Paint (corrosive)	153	3066
Organotin pesticide, solid, toxic	153	2786	Paint, corrosive, flammable	132	3470
Osmium tetroxide	154	2471	Paint (flammable)	128	1263
Other regulated substances, liquid, n.o.s.	171	3082	Paint, flammable, corrosive	132	3469
Other regulated substances, solid, n.o.s.	171	3077	Paint related material (corrosive)	153	3066
Oxidizing liquid, corrosive, n.o.s.	140	3098	Paint related material, corrosive, flammable	132	3470
Oxidizing liquid, n.o.s.	140	3139	Paint related material (flammable)	128	1263
Oxidizing liquid, poisonous, n.o.s.	142	3099	Paint related material, flammable, corrosive	132	3469
Oxidizing liquid, toxic, n.o.s.	142	3099	Paper, unsaturated oil treated	133	1379
Oxidizing solid, corrosive, n.o.s.	140	3085	Paraformaldehyde	133	2213
Oxidizing solid, flammable, n.o.s.	140	3137	Paraldehyde	129	1264
Oxidizing solid, n.o.s.	140	1479	Parathion and compressed gas mixture	123	1967
Oxidizing solid, poisonous, n.o.s.	141	3087	PCB, liquid	171	2315
Oxidizing solid, self-heating, n.o.s.	135	3100	PCB, solid	171	3432
Oxidizing solid, toxic, n.o.s.	141	3087	Pentaborane	135	1380
Oxidizing solid, water-reactive, n.o.s.	144	3121	Pentachloroethane	151	1669
Oxygen, compressed	122	1072	Pentachlorophenol	154	3155
			Pentaerythrite tetranitrate mixture, desensitized, solid, n.o.s., with more than 10% but not more than 20% PETN	113	3344
			Pentaerythritol tetranitrate mixture, desensitized, solid, n.o.s., with more than 10% but not more than 20% PETN	113	3344

Name of Material	Guide No.	ID No.	Name of Material	Guide No.	ID No.
Pentafluoroethane	126	3220	Pesticide, liquid, poisonous, flammable, n.o.s.	131	2903
Pentamethylheptane	128	2286	Pesticide, liquid, poisonous, n.o.s.	151	2902
Pentane-2,4-dione	131	2310	Pesticide, liquid, toxic, flammable, n.o.s.	131	2903
Pentanes	128	1265	Pesticide, liquid, toxic, n.o.s.	151	2902
Pentanols	129	1105	Pesticide, solid, poisonous, n.o.s.	151	2588
1-Pentene	128	1108	Pesticide, solid, toxic, n.o.s.	151	2588
1-Pentol	153P	2705	PETN mixture, desensitized, solid, n.o.s., with more than 10% but not more than 20% PETN	113	3344
Perchlorates, inorganic, aqueous solution, n.o.s.	140	3211	Petrol	128	1203
Perchlorates, inorganic, n.o.s.	140	1481	Petroleum crude oil	128	1267
Perchloric acid, with more than 50% but not more than 72% acid	143	1873	Petroleum distillates, n.o.s.	128	1268
Perchloric acid, with not more than 50% acid	157	1802	Petroleum gases, liquefied	115	1075
Perchloroethylene	160	1897	Petroleum oil	128	1270
Perchloromethyl mercaptan	157	1670	Petroleum products, n.o.s.	128	1268
Perchloryl fluoride	124	3083	Petroleum sour crude oil, flammable, poisonous	131	3494
Perfluoro(ethyl vinyl ether)	115	3154	Petroleum sour crude oil, flammable, toxic	131	3494
Perfluoro(methyl vinyl ether)	115	3153	Phenacyl bromide	153	2645
Perfumery products, with flammable solvents	127	1266	Phenetidines	153	2311
Permanganates, inorganic, aqueous solution, n.o.s.	140	3214	Phenol, molten	153	2312
Permanganates, inorganic, n.o.s.	140	1482	Phenol, solid	153	1671
Peroxides, inorganic, n.o.s.	140	1483	Phenol solution	153	2821
Persulfates, inorganic, aqueous solution, n.o.s.	140	3216	Phenolates, liquid	154	2904
Persulfates, inorganic, n.o.s.	140	3215	Phenolates, solid	154	2905
Persulphates, inorganic, aqueous solution, n.o.s.	140	3216	Phenolsulfonic acid, liquid	153	1803
Persulphates, inorganic, n.o.s.	140	3215	Phenolsulphonic acid, liquid	153	1803
Pesticide, liquid, flammable, poisonous, n.o.s.	131	3021	Phenoxyacetic acid derivative pesticide, liquid, flammable, poisonous	131	3346
Pesticide, liquid, flammable, toxic, n.o.s.	131	3021			

Name of Material	Guide No.	ID No.	Name of Material	Guide No.	ID No.
Phenoxyacetic acid derivative pesticide, liquid, flammable, toxic	131	3346	Phosgene	125	1076
Phenoxyacetic acid derivative pesticide, liquid, poisonous	153	3348	9-Phosphabicyclononanes	135	2940
Phenoxyacetic acid derivative pesticide, liquid, poisonous, flammable	131	3347	Phosphine	119	2199
Phenoxyacetic acid derivative pesticide, liquid, toxic	153	3348	Phosphine, adsorbed	173	3525
Phenoxyacetic acid derivative pesticide, liquid, toxic, flammable	131	3347	Phosphoric acid, solid	154	3453
Phenoxyacetic acid derivative pesticide, solid, poisonous	153	3345	Phosphoric acid, solution	154	1805
Phenoxyacetic acid derivative pesticide, solid, toxic	153	3345	Phosphorous acid	154	2834
Phenylacetoneitrile, liquid	152	2470	Phosphorus, amorphous	133	1338
Phenylacetyl chloride	156	2577	Phosphorus, white, dry or under water or in solution	136	1381
Phenylcarbylamine chloride	151	1672	Phosphorus, white, molten	136	2447
Phenyl chloroformate	156	2746	Phosphorus, yellow, dry or under water or in solution	136	1381
Phenylenediamines	153	1673	Phosphorus heptasulfide, free from yellow and white phosphorus	139	1339
Phenylhydrazine	153	2572	Phosphorus heptasulphide, free from yellow and white phosphorus	139	1339
Phenyl isocyanate	155	2487	Phosphorus oxybromide, molten	137	2576
Phenyl mercaptan	131	2337	Phosphorus oxybromide, solid	137	1939
Phenylmercuric acetate	151	1674	Phosphorus oxychloride	137	1810
Phenylmercuric compound, n.o.s.	151	2026	Phosphorus pentabromide	137	2691
Phenylmercuric hydroxide	151	1894	Phosphorus pentachloride	137	1806
Phenylmercuric nitrate	151	1895	Phosphorus pentafluoride	125	2198
Phenylphosphorus dichloride	137	2798	Phosphorus pentafluoride, adsorbed	173	3524
Phenylphosphorus thiodichloride	137	2799	Phosphorus pentafluoride, compressed	125	2198
Phenyltrichlorosilane	156	1804	Phosphorus pentasulfide, free from yellow and white phosphorus	139	1340
Phenyl urea pesticides, liquid, poisonous	151	3002	Phosphorus pentasulphide, free from yellow and white phosphorus	139	1340
Phenyl urea pesticides, liquid, toxic	151	3002	Phosphorus pentoxide	137	1807

Name of Material	Guide No.	ID No.	Name of Material	Guide No.	ID No.
Phosphorus sesquisulfide, free from yellow and white phosphorus	139	1341	Poisonous by inhalation liquid, corrosive, n.o.s. (Inhalation Hazard Zone A)	154	3389
Phosphorus sesquisulphide, free from yellow and white phosphorus	139	1341	Poisonous by inhalation liquid, corrosive, n.o.s. (Inhalation Hazard Zone B)	154	3390
Phosphorus tribromide	137	1808	Poisonous by inhalation liquid, flammable, corrosive, n.o.s. (Inhalation Hazard Zone A)	131	3488
Phosphorus trichloride	137	1809	Poisonous by inhalation liquid, flammable, corrosive, n.o.s. (Inhalation Hazard Zone B)	131	3489
Phosphorus trioxide	157	2578	Poisonous by inhalation liquid, flammable, n.o.s. (Inhalation Hazard Zone A)	131	3383
Phosphorus trisulfide, free from yellow and white phosphorus	139	1343	Poisonous by inhalation liquid, flammable, n.o.s. (Inhalation Hazard Zone B)	131	3384
Phosphorus trisulphide, free from yellow and white phosphorus	139	1343	Poisonous by inhalation liquid, flammable, n.o.s. (Inhalation Hazard Zone B)	131	3384
Phthalic anhydride	156	2214	Poisonous by inhalation liquid, n.o.s. (Inhalation Hazard Zone A)	151	3381
Picolines	129	2313	Poisonous by inhalation liquid, n.o.s. (Inhalation Hazard Zone B)	151	3382
Picric acid, wetted with not less than 10% water	113	3364	Poisonous by inhalation liquid, oxidizing, n.o.s. (Inhalation Hazard Zone A)	142	3387
Picric acid, wetted with not less than 30% water	113	1344	Poisonous by inhalation liquid, oxidizing, n.o.s. (Inhalation Hazard Zone B)	142	3388
Picrite, wetted with not less than 20% water	113	1336	Poisonous by inhalation liquid, water-reactive, flammable, n.o.s. (Inhalation Hazard Zone A)	155	3490
Picryl chloride, wetted with not less than 10% water	113	3365	Poisonous by inhalation liquid, water-reactive, flammable, n.o.s. (Inhalation Hazard Zone B)	155	3491
Pinene (alpha)	128	2368	Poisonous by inhalation liquid, water-reactive, n.o.s. (Inhalation Hazard Zone A)	139	3385
Pine oil	129	1272	Poisonous by inhalation liquid, water-reactive, n.o.s. (Inhalation Hazard Zone B)	139	3386
Piperazine	153	2579			
Piperidine	132	2401			
Plastic molding compound	171	3314			
Plastics moulding compound	171	3314			
Plastics, nitrocellulose-based, self-heating, n.o.s.	135	2006			
Poisonous by inhalation liquid, corrosive, flammable, n.o.s. (Inhalation Hazard Zone A)	131	3492			
Poisonous by inhalation liquid, corrosive, flammable, n.o.s. (Inhalation Hazard Zone B)	131	3493			

Name of Material	Guide No.	ID No.	Name of Material	Guide No.	ID No.
Poisonous liquid, corrosive, inorganic, n.o.s.	154	3289	Polychlorinated biphenyls, solid	171	3432
Poisonous liquid, corrosive, organic, n.o.s.	154	2927	Polyester resin kit, liquid base material	128	3269
Poisonous liquid, flammable, organic, n.o.s.	131	2929	Polyester resin kit, solid base material	128P	3527
Poisonous liquid, inorganic, n.o.s.	151	3287	Polyhalogenated biphenyls, liquid	171	3151
Poisonous liquid, organic, n.o.s.	153	2810	Polyhalogenated biphenyls, solid	171	3152
Poisonous liquid, oxidizing, n.o.s.	142	3122	Polyhalogenated terphenyls, liquid	171	3151
Poisonous liquid, water-reactive, n.o.s.	139	3123	Polyhalogenated terphenyls, solid	171	3152
Poisonous solid, corrosive, inorganic, n.o.s.	154	3290	Polymeric beads, expandable	171	2211
Poisonous solid, corrosive, organic, n.o.s.	154	2928	Polymerizing substance, liquid, stabilized, n.o.s.	149P	3532
Poisonous solid, flammable, organic, n.o.s.	134	2930	Polymerizing substance, liquid, temperature controlled, n.o.s.	150P	3534
Poisonous solid, inorganic, n.o.s.	151	3288	Polymerizing substance, solid, stabilized, n.o.s.	149P	3531
Poisonous solid, organic, n.o.s.	154	2811	Polymerizing substance, solid, temperature controlled, n.o.s.	150P	3533
Poisonous solid, oxidizing, n.o.s.	141	3086	Potassium	138	2257
Poisonous solid, self-heating, n.o.s.	136	3124	Potassium metal alloys, liquid	138	1420
Poisonous solid, water-reactive, n.o.s.	139	3125	Potassium metal alloys, solid	138	3403
Polyamines, flammable, corrosive, n.o.s.	132	2733	Potassium arsenate	151	1677
Polyamines, liquid, corrosive, flammable, n.o.s.	132	2734	Potassium arsenite	154	1678
Polyamines, liquid, corrosive, n.o.s.	153	2735	Potassium borohydride	138	1870
Polyamines, solid, corrosive, n.o.s.	154	3259	Potassium bromate	140	1484
Polychlorinated biphenyls, liquid	171	2315	Potassium chlorate	140	1485
			Potassium chlorate, aqueous solution	140	2427
			Potassium cuprocyanide	157	1679
			Potassium cyanide, solid	157	1680
			Potassium cyanide, solution	157	3413

Name of Material	Guide No.	ID No.	Name of Material	Guide No.	ID No.
Potassium dithionite	135	1929	Potassium sulfide, with less than 30% water of crystallization	135	1382
Potassium fluoride, solid	154	1812	Potassium sulphide, anhydrous	135	1382
Potassium fluoride, solution	154	3422	Potassium sulphide, hydrated, with not less than 30% water of crystallization	153	1847
Potassium fluoroacetate	151	2628	Potassium sulphide, with less than 30% water of crystallization	135	1382
Potassium fluorosilicate	151	2655	Potassium superoxide	143	2466
Potassium hydrogen difluoride, solid	154	1811	Printing ink, flammable	129	1210
Potassium hydrogen difluoride, solution	154	3421	Printing ink related material, flammable	129	1210
Potassium hydrogen sulfate	154	2509	Propadiene, stabilized	116P	2200
Potassium hydrogen sulphate	154	2509	Propane	115	1075
Potassium hydrosulfite	135	1929	Propane	115	1978
Potassium hydrosulphite	135	1929	Propanethiols	130	2402
Potassium hydroxide, solid	154	1813	n-Propanol	129	1274
Potassium hydroxide, solution	154	1814	Propionaldehyde	129P	1275
Potassium metavanadate	151	2864	Propionic acid	153	1848
Potassium monoxide	154	2033	Propionic acid, with not less than 10% and less than 90% acid	153	1848
Potassium nitrate	140	1486	Propionic acid, with not less than 90% acid	153	3463
Potassium nitrate and sodium nitrite mixture	140	1487	Propionic anhydride	156	2496
Potassium nitrite	140	1488	Propionitrile	131	2404
Potassium perchlorate	140	1489	Propionyl chloride	155	1815
Potassium permanganate	140	1490	n-Propyl acetate	129	1276
Potassium peroxide	144	1491	Propyl alcohol, normal	129	1274
Potassium persulfate	140	1492	Propylamine	132	1277
Potassium persulphate	140	1492	n-Propylbenzene	128	2364
Potassium phosphide	139	2012	Propyl chloride	129	1278
Potassium sodium alloys, liquid	138	1422	n-Propyl chloroformate	155	2740
Potassium sodium alloys, solid	138	3404	Propylene	115	1075
Potassium sulfide, anhydrous	135	1382			
Potassium sulfide, hydrated, with not less than 30% water of crystallization	153	1847			

Name of Material	Guide No.	ID No.	Name of Material	Guide No.	ID No.
Propylene	115	1077	Pyrosulfuryl chloride	137	1817
Propylene chlorohydrin	131	2611	Pyrosulphuryl chloride	137	1817
1,2-Propylenediamine	132	2258	Pyrrolidine	132	1922
Propyleneimine, stabilized	131P	1921	Quinoline	154	2656
Propylene oxide	127P	1280	Radioactive material, excepted package, articles	161	2911
Propylene tetramer	128	2850	Radioactive material, excepted package, articles manufactured from depleted uranium	161	2909
Propyl formates	129	1281	Radioactive material, excepted package, articles manufactured from natural thorium	161	2909
n-Propyl isocyanate	155P	2482	Radioactive material, excepted package, articles manufactured from natural uranium	161	2909
n-Propyl nitrate	128	1865	Radioactive material, excepted package, articles manufactured from natural uranium	161	2909
Propyltrichlorosilane	155	1816	Radioactive material, excepted package, articles manufactured from natural uranium	161	2909
Pyrethroid pesticide, liquid, flammable, poisonous	131	3350	Radioactive material, excepted package, empty packaging	161	2908
Pyrethroid pesticide, liquid, flammable, toxic	131	3350	Radioactive material, excepted package, instruments	161	2911
Pyrethroid pesticide, liquid, poisonous	151	3352	Radioactive material, excepted package, limited quantity of material	161	2910
Pyrethroid pesticide, liquid, poisonous, flammable	131	3351	Radioactive material, low specific activity (LSA-I), non fissile or fissile-excepted	162	2912
Pyrethroid pesticide, liquid, toxic	151	3352	Radioactive material, low specific activity (LSA-II), fissile	165	3324
Pyrethroid pesticide, liquid, toxic, flammable	131	3351	Radioactive material, low specific activity (LSA-II), non fissile or fissile-excepted	162	3321
Pyrethroid pesticide, solid, poisonous	151	3349	Radioactive material, low specific activity (LSA-III), fissile	165	3325
Pyrethroid pesticide, solid, toxic	151	3349	Radioactive material, low specific activity (LSA-III), non fissile or fissile-excepted	162	3322
Pyridine	129	1282			
Pyrophoric alloy, n.o.s.	135	1383			
Pyrophoric liquid, inorganic, n.o.s.	135	3194			
Pyrophoric liquid, organic, n.o.s.	135	2845			
Pyrophoric metal, n.o.s.	135	1383			
Pyrophoric solid, inorganic, n.o.s.	135	3200			
Pyrophoric solid, organic, n.o.s.	135	2846			

Name of Material	Guide No.	ID No.	Name of Material	Guide No.	ID No.
Radioactive material, surface contaminated objects (SCO-I or SCO-II), fissile	165	3326	Radioactive material, uranium hexafluoride, fissile	166	2977
Radioactive material, surface contaminated objects (SCO-I, SCO-II or SCO-III), non fissile or fissile-excepted	162	2913	Radioactive material, uranium hexafluoride, non fissile or fissile-excepted	166	2978
Radioactive material, transported under special arrangement, fissile	165	3331	Rags, oily	133	1856
Radioactive material, transported under special arrangement, non fissile or fissile-excepted	163	2919	Receptacles, small, containing gas	115	2037
Radioactive material, Type A package, fissile, non-special form	165	3327	Red phosphorus	133	1338
Radioactive material, Type A package, non-special form, non fissile or fissile-excepted	163	2915	Refrigerant gas, n.o.s.	126	1078
Radioactive material, Type A package, special form, fissile	165	3333	Refrigerant gases, n.o.s. (flammable)	115	1954
Radioactive material, Type A package, special form, non fissile or fissile-excepted	164	3332	Refrigerant gas R-12	126	1028
Radioactive material, Type B(M) package, fissile	165	3329	Refrigerant gas R-12B1	126	1974
Radioactive material, Type B(M) package, non fissile or fissile-excepted	163	2917	Refrigerant gas R-12B2	171	1941
Radioactive material, Type B(U) package, fissile	165	3328	Refrigerant gas R-13	126	1022
Radioactive material, Type C package, fissile	165	3330	Refrigerant gas R-13B1	126	1009
Radioactive material, Type C package, non fissile or fissile excepted	163	3323	Refrigerant gas R-14	126	1982
			Refrigerant gas R-21	126	1029
			Refrigerant gas R-22	126	1018
			Refrigerant gas R-23	126	1984
			Refrigerant gas R-32	115	3252
			Refrigerant gas R-40	115	1063
			Refrigerant gas R-41	115	2454
			Refrigerant gas R-114	126	1958
			Refrigerant gas R-115	126	1020
			Refrigerant gas R-116	126	2193
			Refrigerant gas R-124	126	1021
			Refrigerant gas R-125	126	3220
			Refrigerant gas R-133a	126	1983
			Refrigerant gas R-134a	126	3159
			Refrigerant gas R-142b	115	2517
			Refrigerant gas R-143a	115	2035
			Refrigerant gas R-152a	115	1030

Name of Material	Guide No.	ID No.	Name of Material	Guide No.	ID No.
Refrigerant gas R-161	115	2453	Rubber shoddy, powdered or granulated	133	1345
Refrigerant gas R-218	126	2424	Rubber solution	127	1287
Refrigerant gas R-227	126	3296	Rubidium	138	1423
Refrigerant gas R-404A	126	3337	Rubidium hydroxide, solid	154	2678
Refrigerant gas R-407A	126	3338	Rubidium hydroxide, solution	154	2677
Refrigerant gas R-407B	126	3339	Safety devices	171	3268
Refrigerant gas R-407C	126	3340	Seat-belt pre-tensioners	171	3268
Refrigerant gas R-500	126	2602	Seed cake, with more than 1.5% oil and not more than 11% moisture	135	1386
Refrigerant gas R-502	126	1973	Seed cake, with not more than 1.5% oil and not more than 11% moisture	135	2217
Refrigerant gas R-503	126	2599	Selenates	151	2630
Refrigerant gas R-1113	119P	1082	Selenic acid	154	1905
Refrigerant gas R-1132a	116P	1959	Selenites	151	2630
Refrigerant gas R-1216	126	1858	Selenium compound, liquid, n.o.s.	151	3440
Refrigerant gas R-1318	126	2422	Selenium compound, solid, n.o.s.	151	3283
Refrigerant gas RC-318	126	1976	Selenium disulfide	153	2657
Refrigerating machines, containing ammonia solutions (UN2672)	126	2857	Selenium disulphide	153	2657
Refrigerating machines, containing flammable, non-poisonous, liquefied gas	115	3358	Selenium hexafluoride	125	2194
Refrigerating machines, containing flammable, non-toxic, liquefied gas	115	3358	Selenium oxychloride	157	2879
Refrigerating machines, containing non-flammable, non-poisonous gases	126	2857	Self-defense spray, non-pressurized	171	3334
Refrigerating machines, containing non-flammable, non-toxic gases	126	2857	Self-heating liquid, corrosive, inorganic, n.o.s.	136	3188
Regulated medical waste, n.o.s.	158	3291	Self-heating liquid, corrosive, organic, n.o.s.	136	3185
Resin solution	128	1866	Self-heating liquid, inorganic, n.o.s.	135	3186
Resorcinol	153	2876	Self-heating liquid, organic, n.o.s.	135	3183
Rosin oil	127	1286	Self-heating liquid, poisonous, inorganic, n.o.s.	136	3187
Rubber scrap, powdered or granulated	133	1345			

Name of Material	Guide No.	ID No.	Name of Material	Guide No.	ID No.
Self-heating liquid, poisonous, organic, n.o.s.	136	3184	Self-reactive solid type B	149	3222
Self-heating liquid, toxic, inorganic, n.o.s.	136	3187	Self-reactive solid type B, temperature controlled	150	3232
Self-heating liquid, toxic, organic, n.o.s.	136	3184	Self-reactive solid type C	149	3224
Self-heating solid, corrosive, inorganic, n.o.s.	136	3192	Self-reactive solid type C, temperature controlled	150	3234
Self-heating solid, corrosive, organic, n.o.s.	136	3126	Self-reactive solid type D	149	3226
Self-heating solid, inorganic, n.o.s.	135	3190	Self-reactive solid type D, temperature controlled	150	3236
Self-heating solid, organic, n.o.s.	135	3088	Self-reactive solid type E	149	3228
Self-heating solid, oxidizing, n.o.s.	135	3127	Self-reactive solid type E, temperature controlled	150	3238
Self-heating solid, poisonous, inorganic, n.o.s.	136	3191	Self-reactive solid type F	149	3230
Self-heating solid, poisonous, organic, n.o.s.	136	3128	Self-reactive solid type F, temperature controlled	150	3240
Self-heating solid, toxic, inorganic, n.o.s.	136	3191	Shale oil	128	1288
Self-heating solid, toxic, organic, n.o.s.	136	3128	Silane	116	2203
Self-reactive liquid type B	149	3221	Silicon powder, amorphous	170	1346
Self-reactive liquid type B, temperature controlled	150	3231	Silicon tetrachloride	157	1818
Self-reactive liquid type C	149	3223	Silicon tetrafluoride	125	1859
Self-reactive liquid type C, temperature controlled	150	3233	Silicon tetrafluoride, adsorbed	173	3521
Self-reactive liquid type D	149	3225	Silicon tetrafluoride, compressed	125	1859
Self-reactive liquid type D, temperature controlled	150	3235	Silver arsenite	151	1683
Self-reactive liquid type E	149	3227	Silver cyanide	151	1684
Self-reactive liquid type E, temperature controlled	150	3237	Silver nitrate	140	1493
Self-reactive liquid type F	149	3229	Silver picrate, wetted with not less than 30% water	113	1347
Self-reactive liquid type F, temperature controlled	150	3239	Sludge acid	153	1906
			Smokeless powder for small arms	133	3178
			Soda lime, with more than 4% sodium hydroxide	154	1907
			Sodium	138	1428
			Sodium aluminate, solid	154	2812
			Sodium aluminate, solution	154	1819

Name of Material	Guide No.	ID No.	Name of Material	Guide No.	ID No.
Sodium aluminum hydride	138	2835	Sodium dinitro-o-cresolate, wetted with not less than 15% water	113	1348
Sodium ammonium vanadate	154	2863	Sodium dithionite	135	1384
Sodium arsanilate	154	2473	Sodium fluoride, solid	154	1690
Sodium arsenate	151	1685	Sodium fluoride, solution	154	3415
Sodium arsenite, aqueous solution	154	1686	Sodium fluoroacetate	151	2629
Sodium arsenite, solid	151	2027	Sodium fluorosilicate	154	2674
Sodium azide	153	1687	Sodium hydride	138	1427
Sodium bisulfate, solution	154	2837	Sodium hydrogendifluoride	154	2439
Sodium bisulphate, solution	154	2837	Sodium hydrosulfide, hydrated, with not less than 25% water of crystallization	154	2949
Sodium borohydride	138	1426	Sodium hydrosulfide, with less than 25% water of crystallization	135	2318
Sodium borohydride and sodium hydroxide solution, with not more than 12% sodium borohydride and not more than 40% sodium hydroxide	157	3320	Sodium hydrosulfide, with not less than 25% water of crystallization	154	2949
Sodium bromate	140	1494	Sodium hydrosulfite	135	1384
Sodium cacodylate	152	1688	Sodium hydrosulphide, hydrated, with not less than 25% water of crystallization	154	2949
Sodium carbonate peroxyhydrate	140	3378	Sodium hydrosulphide, with less than 25% water of crystallization	135	2318
Sodium chlorate	140	1495	Sodium hydrosulphide, with not less than 25% water of crystallization	154	2949
Sodium chlorate, aqueous solution	140	2428	Sodium hydrosulphite	135	1384
Sodium chlorite	143	1496	Sodium hydroxide, solid	154	1823
Sodium chloroacetate	151	2659	Sodium hydroxide, solution	154	1824
Sodium cuprocyanide, solid	157	2316	Sodium hypochlorite	154	1791
Sodium cuprocyanide, solution	157	2317	Sodium ion batteries	147	3551
Sodium cyanide, solid	157	1689	Sodium ion batteries contained in equipment	147	3552
Sodium cyanide, solution	157	3414	Sodium ion batteries packed with equipment	147	3552
Sodium dichloroisocyanurate	140	2465	Sodium methylate, dry	138	1431
Sodium dichloro-s-triazinetrione	140	2465			
Sodium dinitro-o-cresolate, wetted with not less than 10% water	113	3369			

Name of Material	Guide No.	ID No.	Name of Material	Guide No.	ID No.
Sodium methylate, solution in alcohol	132	1289	Solids containing toxic liquid, n.o.s.	151	3243
Sodium monoxide	157	1825	Stannic chloride, anhydrous	137	1827
Sodium nitrate	140	1498	Stannic chloride, pentahydrate	154	2440
Sodium nitrate and potassium nitrate mixture	140	1499	Stannic phosphides	139	1433
Sodium nitrite	141	1500	Stibine	119	2676
Sodium pentachlorophenate	154	2567	Straw, wet, damp or contaminated with oil	133	1327
Sodium perborate monohydrate	140	3377	Strontium arsenite	151	1691
Sodium perchlorate	140	1502	Strontium chlorate	143	1506
Sodium permanganate	140	1503	Strontium nitrate	140	1507
Sodium peroxide	144	1504	Strontium perchlorate	140	1508
Sodium peroxoborate, anhydrous	140	3247	Strontium peroxide	143	1509
Sodium persulfate	140	1505	Strontium phosphide	139	2013
Sodium persulphate	140	1505	Strychnine	151	1692
Sodium phosphide	139	1432	Strychnine salts	151	1692
Sodium picramate, wetted with not less than 20% water	113	1349	Styrene monomer, stabilized	128P	2055
Sodium sulfide, anhydrous	135	1385	Substituted nitrophenol pesticide, liquid, flammable, poisonous	131	2780
Sodium sulfide, hydrated, with not less than 30% water	153	1849	Substituted nitrophenol pesticide, liquid, flammable, toxic	131	2780
Sodium sulfide, with less than 30% water of crystallization	135	1385	Substituted nitrophenol pesticide, liquid, poisonous	153	3014
Sodium sulphide, anhydrous	135	1385	Substituted nitrophenol pesticide, liquid, poisonous, flammable	131	3013
Sodium sulphide, hydrated, with not less than 30% water	153	1849	Substituted nitrophenol pesticide, liquid, toxic	153	3014
Sodium sulphide, with less than 30% water of crystallization	135	1385	Substituted nitrophenol pesticide, liquid, toxic, flammable	131	3013
Sodium superoxide	143	2547	Substituted nitrophenol pesticide, solid, poisonous	153	2779
Solids containing corrosive liquid, n.o.s.	154	3244	Substituted nitrophenol pesticide, solid, toxic	153	2779
Solids containing flammable liquid, n.o.s.	133	3175	Sulfamic acid	154	2967
Solids containing poisonous liquid, n.o.s.	151	3243			

Name of Material	Guide No.	ID No.	Name of Material	Guide No.	ID No.
Sulfur	133	1350	Sulphur tetrafluoride	125	2418
Sulfur, molten	133	2448	Sulphur trioxide, stabilized	137	1829
Sulfur chlorides	137	1828	Sulphuryl chloride	137	1834
Sulfur dioxide	125	1079	Sulphuryl fluoride	123	2191
Sulfur hexafluoride	126	1080	Tars, liquid	130	1999
Sulfuric acid	137	1830	Tear gas candles	159	1700
Sulfuric acid, fuming	137	1831	Tear gas devices	159	1693
Sulfuric acid, spent	137	1832	Tear gas grenades	159	1700
Sulfuric acid, with more than 51% acid	137	1830	Tear gas substance, liquid, n.o.s.	159	1693
Sulfuric acid, with not more than 51% acid	157	2796	Tear gas substance, solid, n.o.s.	159	3448
Sulfuric acid and hydrofluoric acid mixture	157	1786	Tellurium compound, n.o.s.	151	3284
Sulfurous acid	154	1833	Tellurium hexafluoride	125	2195
Sulfur tetrafluoride	125	2418	Terpene hydrocarbons, n.o.s.	128	2319
Sulfur trioxide, stabilized	137	1829	Terpinolene	128	2541
Sulfuryl chloride	137	1834	Tetrabromoethane	159	2504
Sulfuryl fluoride	123	2191	1,1,2,2-Tetrachloroethane	151	1702
Sulphamic acid	154	2967	Tetrachloroethylene	160	1897
Sulphur	133	1350	Tetraethyl dithiopyrophosphate	153	1704
Sulphur, molten	133	2448	Tetraethylenepentamine	153	2320
Sulphur chlorides	137	1828	Tetraethyl silicate	129	1292
Sulphur dioxide	125	1079	1,1,1,2-Tetrafluoroethane	126	3159
Sulphur hexafluoride	126	1080	Tetrafluoroethylene, stabilized	116P	1081
Sulphuric acid	137	1830	Tetrafluoromethane	126	1982
Sulphuric acid, fuming	137	1831	1,2,3,6-Tetrahydrobenzaldehyde	129	2498
Sulphuric acid, spent	137	1832	Tetrahydrofuran	127	2056
Sulphuric acid, with more than 51% acid	137	1830	Tetrahydrofurfurylamine	129	2943
Sulphuric acid, with not more than 51% acid	157	2796	Tetrahydrophthalic anhydrides	156	2698
Sulphuric acid and hydrofluoric acid mixture	157	1786	1,2,3,6-Tetrahydropyridine	129	2410
Sulphurous acid	154	1833	Tetrahydrothiophene	130	2412

Name of Material	Guide No.	ID No.	Name of Material	Guide No.	ID No.
Tetramethylammonium hydroxide aqueous solution with more than 2.5% but less than 25% tetramethylammonium hydroxide	153	1835	Thioglycol	153	2966
Tetramethylammonium hydroxide aqueous solution with not less than 25% tetramethylammonium hydroxide	153	3560	Thioglycolic acid	153	1940
Tetramethylammonium hydroxide, solid	153	3423	Thiolactic acid	153	2936
Tetramethylammonium hydroxide, solution	153	1835	Thionyl chloride	137	1836
Tetramethylsilane	130	2749	Thiophene	130	2414
Tetranitromethane	143	1510	Thiophosgene	156	2474
Tetrapropyl orthotitanate	128	2413	Thiophosphoryl chloride	157	1837
Textile waste, wet	133	1857	Thiourea dioxide	135	3341
Thallium chlorate	141	2573	Tinctures, medicinal	127	1293
Thallium compound, n.o.s.	151	1707	Tin tetrachloride	137	1827
Thallium nitrate	141	2727	Titanium disulfide	135	3174
4-Thiapentanal	152	2785	Titanium disulphide	135	3174
Thioacetic acid	129	2436	Titanium hydride	170	1871
Thiocarbamate pesticide, liquid, flammable, poisonous	131	2772	Titanium powder, dry	135	2546
Thiocarbamate pesticide, liquid, flammable, toxic	131	2772	Titanium powder, wetted with not less than 25% water	170	1352
Thiocarbamate pesticide, liquid, poisonous	151	3006	Titanium sponge granules	170	2878
Thiocarbamate pesticide, liquid, poisonous, flammable	131	3005	Titanium sponge powders	170	2878
Thiocarbamate pesticide, liquid, toxic	151	3006	Titanium tetrachloride	137	1838
Thiocarbamate pesticide, liquid, toxic, flammable	131	3005	Titanium trichloride, pyrophoric	135	2441
Thiocarbamate pesticide, solid, poisonous	151	2771	Titanium trichloride mixture	157	2869
Thiocarbamate pesticide, solid, toxic	151	2771	Titanium trichloride mixture, pyrophoric	135	2441
			TNT, wetted with not less than 10% water	113	3366
			TNT, wetted with not less than 30% water	113	1356
			Toluene	130	1294
			2,4-Toluenediamine, solid	151	1709
			2,4-Toluenediamine, solution	151	3418
			Toluene diisocyanate	156	2078
			Toluidines, liquid	153	1708
			Toluidines, solid	153	3451
			2,4-Toluylenediamine, solid	151	1709

Name of Material	Guide No.	ID No.
2,4-Toluylenediamine, solution	151	3418
Toxic by inhalation liquid, corrosive, flammable, n.o.s. (Inhalation Hazard Zone A)	131	3492
Toxic by inhalation liquid, corrosive, flammable, n.o.s. (Inhalation Hazard Zone B)	131	3493
Toxic by inhalation liquid, corrosive, n.o.s. (Inhalation Hazard Zone A)	154	3389
Toxic by inhalation liquid, corrosive, n.o.s. (Inhalation Hazard Zone B)	154	3390
Toxic by inhalation liquid, flammable, corrosive, n.o.s. (Inhalation Hazard Zone A)	131	3488
Toxic by inhalation liquid, flammable, corrosive, n.o.s. (Inhalation Hazard Zone B)	131	3489
Toxic by inhalation liquid, flammable, n.o.s. (Inhalation Hazard Zone A)	131	3383
Toxic by inhalation liquid, flammable, n.o.s. (Inhalation Hazard Zone B)	131	3384
Toxic by inhalation liquid, n.o.s. (Inhalation Hazard Zone A)	151	3381
Toxic by inhalation liquid, n.o.s. (Inhalation Hazard Zone B)	151	3382
Toxic by inhalation liquid, oxidizing, n.o.s. (Inhalation Hazard Zone A)	142	3387
Toxic by inhalation liquid, oxidizing, n.o.s. (Inhalation Hazard Zone B)	142	3388
Toxic by inhalation liquid, water-reactive, flammable, n.o.s. (Inhalation Hazard Zone A)	155	3490

Name of Material	Guide No.	ID No.
Toxic by inhalation liquid, water-reactive, flammable, n.o.s. (Inhalation Hazard Zone B)	155	3491
Toxic by inhalation liquid, water-reactive, n.o.s. (Inhalation Hazard Zone A)	139	3385
Toxic by inhalation liquid, water-reactive, n.o.s. (Inhalation Hazard Zone B)	139	3386
Toxic liquid, corrosive, inorganic, n.o.s.	154	3289
Toxic liquid, corrosive, organic, n.o.s.	154	2927
Toxic liquid, flammable, organic, n.o.s.	131	2929
Toxic liquid, inorganic, n.o.s.	151	3287
Toxic liquid, organic, n.o.s.	153	2810
Toxic liquid, oxidizing, n.o.s.	142	3122
Toxic liquid, water-reactive, n.o.s.	139	3123
Toxic solid, corrosive, inorganic, n.o.s.	154	3290
Toxic solid, corrosive, organic, n.o.s.	154	2928
Toxic solid, flammable, inorganic, n.o.s.	134	3535
Toxic solid, flammable, organic, n.o.s.	134	2930
Toxic solid, inorganic, n.o.s.	151	3288
Toxic solid, organic, n.o.s.	154	2811
Toxic solid, oxidizing, n.o.s.	141	3086
Toxic solid, self-heating, n.o.s.	136	3124
Toxic solid, water-reactive, n.o.s.	139	3125
Toxins, extracted from living sources, liquid, n.o.s.	152	3172
Toxins, extracted from living sources, solid, n.o.s.	152	3462

Name of Material	Guide No.	ID No.	Name of Material	Guide No.	ID No.
Triallylamine	132	2610	1,1,1-Trifluoroethane	115	2035
Triallyl borate	156	2609	Trifluoromethane	126	1984
Triazine pesticide, liquid, flammable, poisonous	131	2764	Trifluoromethane, refrigerated liquid	120	3136
Triazine pesticide, liquid, flammable, toxic	131	2764	2-Trifluoromethylaniline	153	2942
Triazine pesticide, liquid, poisonous	151	2998	3-Trifluoromethylaniline	153	2948
Triazine pesticide, liquid, poisonous, flammable	131	2997	Trifluoromethyltetrazole-sodium salt in acetone	113	3555
Triazine pesticide, liquid, toxic	151	2998	Triisobutylene	128	2324
Triazine pesticide, liquid, toxic, flammable	131	2997	Triisopropyl borate	129	2616
Triazine pesticide, solid, poisonous	151	2763	Trimethoxysilane	132	9269
Triazine pesticide, solid, toxic	151	2763	Trimethylacetyl chloride	131	2438
Tributylamine	153	2542	Trimethylamine, anhydrous	118	1083
Tributylphosphane	135	3254	Trimethylamine, aqueous solution	132	1297
Trichloroacetic acid	153	1839	1,3,5-Trimethylbenzene	129	2325
Trichloroacetic acid, solution	153	2564	Trimethyl borate	129	2416
Trichloroacetyl chloride	156	2442	Trimethylchlorosilane	155	1298
Trichlorobenzenes, liquid	153	2321	Trimethylcyclohexylamine	153	2326
Trichlorobutene	152	2322	Trimethylhexamethylenediamines	153	2327
1,1,1-Trichloroethane	160	2831	Trimethylhexamethylene diisocyanate	156	2328
Trichloroethylene	160	1710	Trimethyl phosphite	130	2329
Trichloroisocyanuric acid, dry	140	2468	Trinitrobenzene, wetted with not less than 10% water	113	3367
Trichlorosilane	139	1295	Trinitrobenzene, wetted with not less than 30% water	113	1354
Tricresyl phosphate	151	2574	Trinitrobenzoic acid, wetted with not less than 10% water	113	3368
Triethylamine	132	1296	Trinitrobenzoic acid, wetted with not less than 30% water	113	1355
Triethylenetetramine	153	2259	Trinitrochlorobenzene, wetted with not less than 10% water	113	3365
Triethyl phosphite	130	2323	Trinitrophenol, wetted with not less than 10% water	113	3364
Trifluoroacetic acid	154	2699	Trinitrophenol, wetted with not less than 30% water	113	1344
Trifluoroacetyl chloride	125	3057			
Trifluorochloroethylene, stabilized	119P	1082			

Name of Material	Guide No.	ID No.	Name of Material	Guide No.	ID No.
Trinitrotoluene, wetted with not less than 10% water	113	3366	Vehicle, flammable gas powered	115	3166
Trinitrotoluene, wetted with not less than 30% water	113	1356	Vehicle, flammable liquid powered	128	3166
Tripropylamine	132	2260	Vehicle, fuel cell, flammable gas powered	115	3166
Tripropylene	128	2057	Vehicle, fuel cell, flammable liquid powered	128	3166
Tris-(1-aziridinyl)phosphine oxide, solution	152	2501	Vehicle, lithium ion battery powered	147	3556
Tungsten hexafluoride	125	2196	Vehicle, lithium metal battery powered	138	3557
Turpentine	128	1299	Vehicle, sodium ion battery powered	147	3558
Turpentine substitute	128	1300	Vinyl acetate, stabilized	129P	1301
Undecane	128	2330	Vinyl bromide, stabilized	116P	1085
Uranium hexafluoride, radioactive material, excepted package, less than 0.1 kg per package, non-fissile or fissile-excepted	166	3507	Vinyl butyrate, stabilized	129P	2838
Uranium hexafluoride, radioactive material, fissile	166	2977	Vinyl chloride, stabilized	116P	1086
Uranium hexafluoride, radioactive material, non fissile or fissile-excepted	166	2978	Vinyl chloroacetate	155	2589
Urea hydrogen peroxide	140	1511	Vinyl ethyl ether, stabilized	127P	1302
Urea nitrate, wetted with not less than 10% water	113	3370	Vinyl fluoride, stabilized	116P	1860
Urea nitrate, wetted with not less than 20% water	113	1357	Vinylidene chloride, stabilized	130P	1303
Valeraldehyde	129	2058	Vinyl isobutyl ether, stabilized	127P	1304
Valeryl chloride	132	2502	Vinyl methyl ether, stabilized	116P	1087
Vanadium compound, n.o.s.	151	3285	Vinylpyridines, stabilized	131P	3073
Vanadium oxytrichloride	137	2443	Vinyltoluenes, stabilized	130P	2618
Vanadium pentoxide	151	2862	Vinyltrichlorosilane	155P	1305
Vanadium tetrachloride	137	2444	Water-reactive liquid, corrosive, n.o.s.	138	3129
Vanadium trichloride	157	2475	Water-reactive liquid, n.o.s.	138	3148
Vanadyl sulfate	151	2931	Water-reactive liquid, poisonous, n.o.s.	139	3130
Vanadyl sulphate	151	2931	Water-reactive liquid, toxic, n.o.s.	139	3130
			Water-reactive solid, corrosive, n.o.s.	138	3131

Name of Material	Guide No.	ID No.	Name of Material	Guide No.	ID No.
Water-reactive solid, flammable, n.o.s.	138	3132	Zinc arsenite	151	1712
Water-reactive solid, n.o.s.	138	2813	Zinc ashes	138	1435
Water-reactive solid, oxidizing, n.o.s.	138	3133	Zinc bromate	140	2469
Water-reactive solid, poisonous, n.o.s.	139	3134	Zinc chlorate	140	1513
Water-reactive solid, self-heating, n.o.s.	138	3135	Zinc chloride, anhydrous	154	2331
Water-reactive solid, toxic, n.o.s.	139	3134	Zinc chloride, solution	154	1840
Wheelchair, electric, with batteries	154	3171	Zinc cyanide	151	1713
White phosphorus, dry or under water or in solution	136	1381	Zinc dithionite	171	1931
White phosphorus, molten	136	2447	Zinc dross	138	1435
Wood preservatives, liquid	129	1306	Zinc dust	138	1436
Wool waste, wet	133	1387	Zinc fluorosilicate	151	2855
Xanthates	135	3342	Zinc hydrosulfite	171	1931
Xenon	120	2036	Zinc hydrosulphite	171	1931
Xenon, compressed	120	2036	Zinc nitrate	140	1514
Xenon, refrigerated liquid (cryogenic liquid)	120	2591	Zinc permanganate	140	1515
Xylenes	130	1307	Zinc peroxide	143	1516
Xylenols, liquid	153	3430	Zinc phosphide	139	1714
Xylenols, solid	153	2261	Zinc powder	138	1436
Xylidines, liquid	153	1711	Zinc residue	138	1435
Xylidines, solid	153	3452	Zinc resinate	133	2714
Xylyl bromide, liquid	152	1701	Zinc silicofluoride	151	2855
Xylyl bromide, solid	152	3417	Zinc skimmings	138	1435
Yellow phosphorus, dry or under water or in solution	136	1381	Zirconium, dry, coiled wire, finished metal sheets, strip	170	2858
Zinc ammonium nitrite	140	1512	Zirconium, dry, finished sheets, strip or coiled wire	135	2009
Zinc arsenate	151	1712	Zirconium hydride	138	1437
Zinc arsenate and zinc arsenite mixture	151	1712	Zirconium nitrate	140	2728
			Zirconium picramate, wetted with not less than 20% water	113	1517
			Zirconium powder, dry	135	2008
			Zirconium powder, wetted with not less than 25% water	170	1358
			Zirconium scrap	135	1932

Name of Material	Guide No.	ID No.	Name of Material	Guide No.	ID No.
Zirconium suspended in a flammable liquid	170	1308			
Zirconium suspended in a liquid (flammable)	170	1308			
Zirconium tetrachloride	137	2503			

SUGGESTED OPERATIONS SHOULD ONLY BE PERFORMED BY ADEQUATELY TRAINED AND EQUIPPED PERSONNEL

HOW TO USE THE ORANGE GUIDES

1	GUIDE 117 GASES - TOXIC - FLAMMABLE (EXTREME HAZARD)	GASES - TOXIC - FLAMMABLE (EXTREME HAZARD) GUIDE 117	
	POTENTIAL HAZARDS	EMERGENCY RESPONSE	
2	HEALTH <ul style="list-style-type: none">• TOXIC; Extremely Hazardous.• May be fatal if inhaled or absorbed through skin.• Initial odor may be irritating or foul and may deaden your sense of smell.• Contact with gas or liquefied gas may cause burns, severe injury and/or frostbite.• Fire will produce irritating, corrosive and/or toxic gases.• Runoff from fire control or dilution water may cause environmental contamination. FIRE OR EXPLOSION <ul style="list-style-type: none">• These materials are extremely flammable.• May form explosive mixture with air.• May be ignited by heat, sparks or flames.• Vapors from liquefied gas are initially heavier than air and spread along ground.• Vapors may travel to source of ignition and flash back.• Those substances designated with a (P) may polymerize explosively when heated or involved in a fire.• Runoff may create fire or explosion hazard.• Containers exposed to fire may vent and release toxic and flammable gas through pressure relief devices.• Containers may explode when heated.• Ruptured cylinders may rocket. PUBLIC SAFETY <ul style="list-style-type: none">• CALL 911. Then call emergency response telephone number on shipping paper. If shipping paper not available or no answer, refer to appropriate telephone number listed on the inside back cover.• Keep unauthorized personnel away.• Stay upwind, uphill and/or upstream.• Many gases are heavier than air and will spread along the ground and collect in low or confined areas (sewers, basements, tanks, etc.).• Ventilated closed spaces before entering, but only if properly trained and equipped. PROTECTIVE CLOTHING <ul style="list-style-type: none">• Wear positive pressure self-contained breathing apparatus (SCBA).• Wear chemical protective clothing that is specifically recommended by the manufacturer when there is NO RISK OF FIRE.• Structural firefighters' protective clothing provides thermal protection but only limited chemical protection. EVACUATION <p>Immediate precautionary measure</p> <ul style="list-style-type: none">• Isolate spill or leak area for at least 100 meters (330 feet) in all directions. <p>Spill</p> <ul style="list-style-type: none">• See Table 1: Initial Isolation and Protective Action Distances. <p>Fire</p> <ul style="list-style-type: none">• If tank, rail tank car or highway tank is involved in a fire, ISOLATE for 1600 meters (1 mile) in all directions; also, consider initial evacuation for 1600 meters (1 mile) in all directions.	FIRE <ul style="list-style-type: none">• DO NOT EXTINGUISH A LEAKING GAS FIRE UNLESS LEAK CAN BE STOPPED.• Small Fire<ul style="list-style-type: none">• Dry chemical, CO₂, water spray or regular foam.• Large Fire<ul style="list-style-type: none">• Water spray, fog or regular foam.• If it can be done safely, move undamaged containers away from the area around the fire.• Damaged cylinders should be handled only by specialists.• Fire Involving Tanks<ul style="list-style-type: none">• Fight fire from maximum distance or use unmanned master stream devices or monitor nozzles.• Cool containers with flooding quantities of water until well after fire is out.• Do not direct water at source of leak or safety devices; strong may occur.• Withdraw immediately in case of rising sound from venting safety devices or discoloration of tank.• ALWAYS stay away from tanks in direct contact with flames.• SPILL OR LEAK<ul style="list-style-type: none">• ELIMINATE all ignition sources (no smoking, flares, sparks or flames) from immediate area.• All equipment used when handling the product must be grounded.• Do not touch or walk through spilled material.• Stop leak if you can do it without risk.• Use water spray to reduce vapors or divert vapor cloud drift. Avoid allowing water runoff to contact spilled material.• Do not direct water at spill or source of leak.• If possible, aim leaking containers so that gas escapes rather than liquid.• Prevent entry into waterways, sewers, basements or confined areas.• Isolate area until gas has dispersed.• Consider igniting spill or leak to eliminate toxic gas concern. FIRST AID <p>Refer to the "General First Aid" section.</p> <p>Specific First Aid:</p> <ul style="list-style-type: none">• In case of contact with liquefied gas, only medical personnel should attempt thawing frost-bitten parts.• In case of burns, immediately cool affected skin for as long as possible with cold water. Do not remove clothing if adhering to skin.	4
3			

Page 164

ERG 2024

ERG 2024

Page 165

1

GUIDE NUMBER AND TITLE

- The guide title identifies the general hazards associated with the materials in this Guide.

2

POTENTIAL HAZARDS

- Emergency responders should consult this section first!
- Describes the material hazard in terms of **FIRE OR EXPLOSION** and **HEALTH** effects upon exposure.
- The primary potential hazard is listed first.
- Allows the responders to make decisions to protect the emergency response team, and the surrounding population.

SUGGESTED OPERATIONS SHOULD ONLY BE PERFORMED BY ADEQUATELY TRAINED AND EQUIPPED PERSONNEL

3

PUBLIC SAFETY

- This section is divided into three subsections:
 - › **General Information:** describes initial precautionary measures to be taken by those first on the scene.
 - › **PROTECTIVE CLOTHING:** provides general guidance on personal protective equipment requirements including respiratory protection. The protective clothing information is general and correct selection is situation dependent, after considering the physical and chemical properties of the material, weather conditions, spill versus fire, topography, etc.
 - › **EVACUATION:** suggests protective distances for immediate precautionary measures defined for small and large spills, including suggested guidance for conditions where fire is present or likely (potential fragmentation hazard).
 - The term “isolate” indicates a zone of no entry that applies to the public and first responders who are not equipped, trained, and prepared to mitigate the incident.
 - The term “evacuate” aims to protect as many people as possible by removing persons from inside a zone safely. If removal is too risky, sheltering-in-place can also be considered in this zone.
- Materials **highlighted in green** in the yellow and blue sections direct the reader to consult Table 1, detailing specific response distances for toxic inhalation hazard materials and water-reactive materials (green section).

4

EMERGENCY RESPONSE

- This section is divided into three subsections:
 - › **FIRE:** provides extinguishing procedures for **Small Fire, Large Fire, and/or Fire Involving Tanks or Car/Trailer Loads**
 - › **SPILL OR LEAK:** includes general recommendations, and may describe the response procedure for **Small Spill and Large Spill**
 - › **FIRST AID:** provides specific first aid guidance to use for a product or a guide in addition to the general first aid guidance for hazardous materials/dangerous goods incidents. General first aid guidance is found in the “General First Aid” section situated immediately after the “How to use the Orange Guides” section.



If a Canadian flag appears in this section, and the incident is located in Canada, an Emergency Response Assistance Plan (ERAP) may be required for this product.

GENERAL FIRST AID

- Call 911 or emergency medical service.
- Ensure that medical personnel are aware of the material(s) involved, take precautions to protect themselves and avoid contamination.
- Move victim to fresh air if it can be done safely.
- Administer oxygen if breathing is difficult.
- If victim is not breathing:
 - DO NOT perform mouth-to-mouth resuscitation; the victim may have ingested or inhaled the substance.
 - If equipped and pulse detected, wash face and mouth, then give artificial respiration using a proper respiratory medical device (bag-valve mask, pocket mask equipped with a one-way valve or other device).
 - If no pulse detected or no respiratory medical device available, provide continuous compressions. Conduct a pulse check every two minutes or monitor for any signs of spontaneous respirations.
- Remove and isolate contaminated clothing and shoes.
- For minor skin contact, avoid spreading material on unaffected skin.
- In case of contact with substance, remove immediately by flushing skin or eyes with running water for at least 20 minutes.
- For severe burns, immediate medical attention is required.
- Effects of exposure (inhalation, ingestion, or skin contact) to substance may be delayed.
- Keep victim calm and warm.
- Keep victim under observation.
- For further assistance, contact your local Poison Control Center.
- **Note:** Basic Life Support (BLS) and Advanced Life Support (ALS) should be done by trained professionals.

NOTES

GUIDE MIXED LOAD/UNIDENTIFIED CARGO

111

POTENTIAL HAZARDS

FIRE OR EXPLOSION

- May explode from heat, shock, friction or contamination.
- May react violently or explosively on contact with air, water or foam.
- May be ignited by heat, sparks or flames.
- Vapors may travel to source of ignition and flash back.
- Containers may explode when heated.
- Ruptured cylinders may rocket.

HEALTH

- Inhalation, ingestion or contact with substance may cause severe injury, infection, disease or death.
- High concentration of gas may cause asphyxiation without warning.
- Contact may cause burns to skin and eyes.
- Fire or contact with water may produce irritating, toxic and/or corrosive gases.
- Runoff from fire control or dilution water may cause environmental contamination.

PUBLIC SAFETY

- **CALL 911. Then call emergency response telephone number on shipping paper.** If shipping paper not available or no answer, refer to appropriate telephone number listed on the inside back cover.
- Keep unauthorized personnel away.
- Stay upwind, uphill and/or upstream.

PROTECTIVE CLOTHING

- Wear positive pressure self-contained breathing apparatus (SCBA).
- Structural firefighters' protective clothing provides thermal protection **but only limited chemical protection.**

EVACUATION

Immediate precautionary measure

- Isolate spill or leak area for at least 100 meters (330 feet) in all directions.

Fire

- If tank, rail tank car or highway tank is involved in a fire, ISOLATE for 800 meters (1/2 mile) in all directions; also, consider initial evacuation for 800 meters (1/2 mile) in all directions.

EMERGENCY RESPONSE

FIRE

CAUTION: Material may react with extinguishing agent.

Small Fire

- Dry chemical, CO₂, water spray or regular foam.

Large Fire

- Water spray, fog or regular foam.
- If it can be done safely, move undamaged containers away from the area around the fire.

Fire Involving Tanks

- Cool containers with flooding quantities of water until well after fire is out.
- Do not get water inside containers.
- Withdraw immediately in case of rising sound from venting safety devices or discoloration of tank.
- ALWAYS stay away from tanks in direct contact with flames.

SPILL OR LEAK

- Do not touch or walk through spilled material.
- ELIMINATE all ignition sources (no smoking, flares, sparks or flames) from immediate area.
- All equipment used when handling the product must be grounded.
- Keep combustibles (wood, paper, oil, etc.) away from spilled material.
- Use water spray to reduce vapors or divert vapor cloud drift. Avoid allowing water runoff to contact spilled material.
- Prevent entry into waterways, sewers, basements or confined areas.

Small Spill

- Pick up with sand or other non-combustible absorbent material and place into containers for later disposal.

Large Spill

- Dike far ahead of liquid spill for later disposal.

FIRST AID

Refer to the "General First Aid" section.

GUIDE EXPLOSIVES* - DIVISION 1.1, 1.2, 1.3 OR 1.5

112

POTENTIAL HAZARDS

FIRE OR EXPLOSION

- **MAY EXPLODE AND THROW FRAGMENTS 1600 METERS (1 MILE) OR MORE IF FIRE REACHES CARGO.**

HEALTH

- Fire may produce irritating, corrosive and/or toxic gases.

PUBLIC SAFETY

- **CALL 911. Then call emergency response telephone number on shipping paper.** If shipping paper not available or no answer, refer to appropriate telephone number listed on the inside back cover.
- Move people out of line of sight of the scene and away from windows.
- Keep unauthorized personnel away.
- Stay upwind, uphill and/or upstream.
- Ventilate closed spaces before entering, but only if properly trained and equipped.

PROTECTIVE CLOTHING

- Wear positive pressure self-contained breathing apparatus (SCBA).
- Structural firefighters' protective clothing provides thermal protection **but only limited chemical protection.**

EVACUATION

Immediate precautionary measure

- Isolate spill or leak area immediately for at least 500 meters (1/3 mile) in all directions.

Large Spill

- Consider initial evacuation for 800 meters (1/2 mile) in all directions.

Fire

- If rail car or trailer is involved in a fire, ISOLATE for 1600 meters (1 mile) in all directions; also, initiate evacuation including emergency responders for 1600 meters (1 mile) in all directions.

* FOR INFORMATION ON "COMPATIBILITY GROUP" LETTERS, REFER TO THE GLOSSARY SECTION.

EMERGENCY RESPONSE

FIRE

CARGO Fire

- **DO NOT fight fire when fire reaches cargo! Cargo may EXPLODE!**
- Stop all traffic and clear the area for at least 1600 meters (1 mile) in all directions and let burn.
- **Do not move cargo or vehicle if cargo has been exposed to heat.**

TIRE or VEHICLE Fire

- **Use plenty of water - FLOOD it! If water is not available, use CO₂, dry chemical or dirt.**
- If possible, and WITHOUT RISK, use unmanned master stream devices or monitor nozzles from maximum distance to prevent fire from spreading to cargo area.
- Pay special attention to tire fires as re-ignition may occur. Stand by, at a safe distance, with extinguisher ready for possible re-ignition.

SPILL OR LEAK

- ELIMINATE all ignition sources (no smoking, flares, sparks or flames) from immediate area.
- All equipment used when handling the product must be grounded.
- Do not touch or walk through spilled material.
- DO NOT OPERATE RADIO TRANSMITTERS WITHIN 100 METERS (330 FEET) OF ELECTRIC DETONATORS.
- **DO NOT CLEAN-UP OR DISPOSE OF, EXCEPT UNDER SUPERVISION OF A SPECIALIST.**

FIRST AID

Refer to the "General First Aid" section.



In Canada, an Emergency Response Assistance Plan (ERAP) may be required for this product. Please consult the shipping paper and/or the "ERAP" section.

GUIDE 113 FLAMMABLE MATERIALS (WET/DESENSITIZED EXPLOSIVE)

POTENTIAL HAZARDS

FIRE OR EXPLOSION

- Flammable/combustible material.
- May be ignited by heat, sparks or flames.
- **DRIED OUT material may explode if exposed to heat, flame, friction or shock; treat as an explosive (GUIDE 112).**
- **Keep material wet with water or treat as an explosive (GUIDE 112).**
- Runoff to sewer may create fire or explosion hazard.

HEALTH

- **Some are toxic** and may be fatal if inhaled, ingested or absorbed through skin. Specifically, Dinitrophenol, wetted (UN1320); Dinitrophenolates, wetted (UN1321), Sodium dinitro-o-cresolate, wetted (UN1348); and Barium azide, wetted (UN1571) are known to be toxic.
- Contact may cause burns to skin and eyes.
- Fire may produce irritating, corrosive and/or toxic gases.
- Runoff from fire control or dilution water may cause environmental contamination.

PUBLIC SAFETY

- **CALL 911. Then call emergency response telephone number on shipping paper.** If shipping paper not available or no answer, refer to appropriate telephone number listed on the inside back cover.
- Keep unauthorized personnel away.
- Stay upwind, uphill and/or upstream.
- Ventilate closed spaces before entering, but only if properly trained and equipped.

PROTECTIVE CLOTHING

- Wear positive pressure self-contained breathing apparatus (SCBA).
- Structural firefighters' protective clothing provides thermal protection **but only limited chemical protection.**

EVACUATION

Immediate precautionary measure

- Isolate spill or leak area immediately for at least 100 meters (330 feet) in all directions.

Large Spill

- **Consider initial evacuation for 500 meters (1/3 mile) in all directions.**

Fire

- If tank, rail tank car or highway tank is involved in a fire, ISOLATE for 800 meters (1/2 mile) in all directions; also, consider initial evacuation for 800 meters (1/2 mile) in all directions.

EMERGENCY RESPONSE

FIRE

CARGO Fire

- **DO NOT fight fire when fire reaches cargo! Cargo may EXPLODE!**
- Stop all traffic and clear the area for at least 1600 meters (1 mile) in all directions and let burn.
- **Do not move cargo or vehicle if cargo has been exposed to heat.**

TIRE or VEHICLE Fire

- **Use plenty of water - FLOOD it! If water is not available, use CO₂, dry chemical or dirt.**
- If possible, and WITHOUT RISK, use unmanned master stream devices or monitor nozzles from maximum distance to prevent fire from spreading to cargo area.
- Pay special attention to tire fires as re-ignition may occur. Stand by, at a safe distance, with extinguisher ready for possible re-ignition.

SPILL OR LEAK

- ELIMINATE all ignition sources (no smoking, flares, sparks or flames) from immediate area.
- All equipment used when handling the product must be grounded.
- Do not touch or walk through spilled material.

Small Spill

- Flush area with large amounts of water.

Large Spill

- Wet down with water and dike for later disposal.
- **KEEP "WETTED" PRODUCT WET BY SLOWLY ADDING FLOODING QUANTITIES OF WATER.**

FIRST AID

Refer to the "General First Aid" section.



In Canada, an Emergency Response Assistance Plan (ERAP) may be required for this product. Please consult the shipping paper and/or the "ERAP" section.

GUIDE EXPLOSIVES* - DIVISION 1.4 OR 1.6

114

POTENTIAL HAZARDS

FIRE OR EXPLOSION

- **MAY EXPLODE AND THROW FRAGMENTS 800 METERS (1/2 MILE) OR MORE IF FIRE REACHES CARGO.**

HEALTH

- Fire may produce irritating, corrosive and/or toxic gases.

PUBLIC SAFETY

- **CALL 911. Then call emergency response telephone number on shipping paper.** If shipping paper not available or no answer, refer to appropriate telephone number listed on the inside back cover.
- Move people out of line of sight of the scene and away from windows.
- Keep unauthorized personnel away.
- Stay upwind, uphill and/or upstream.
- Ventilate closed spaces before entering, but only if properly trained and equipped.

PROTECTIVE CLOTHING

- Wear positive pressure self-contained breathing apparatus (SCBA).
- Structural firefighters' protective clothing provides thermal protection **but only limited chemical protection.**

EVACUATION

Immediate precautionary measure

- Isolate spill or leak area immediately for at least 100 meters (330 feet) in all directions.

Large Spill

- **Consider initial evacuation for 250 meters (800 feet) in all directions.**

Fire

- If rail car or trailer is involved in a fire, ISOLATE for 800 meters (1/2 mile) in all directions; also initiate evacuation including emergency responders for 800 meters (1/2 mile) in all directions.
- If fire threatens cargo area containing packages bearing the 1.4S label or packages containing material classified as 1.4S, consider isolating at least 15 meters (50 feet) in all directions.

*** FOR INFORMATION ON "COMPATIBILITY GROUP" LETTERS, REFER TO THE GLOSSARY SECTION.**

EMERGENCY RESPONSE

FIRE**CARGO Fire**

- **DO NOT fight fire when fire reaches cargo! Cargo may EXPLODE!**
- Stop all traffic and clear the area for at least 800 meters (1/2 mile) in all directions and let burn.
- **Do not move cargo or vehicle if cargo has been exposed to heat.**

TIRE or VEHICLE Fire

- **Use plenty of water - FLOOD it! If water is not available, use CO₂, dry chemical or dirt.**
- If possible, and WITHOUT RISK, use unmanned master stream devices or monitor nozzles from maximum distance to prevent fire from spreading to cargo area.
- Pay special attention to tire fires as re-ignition may occur. Stand by, at a safe distance, with extinguisher ready for possible re-ignition.

CLASS 1.4S Fire

- Packages bearing the 1.4S label or packages containing material classified as 1.4S are designed or packaged in such a manner that when involved in a fire, they may burn vigorously with localized detonations and projection of fragments.
- Effects are usually confined to immediate vicinity of packages.
- Fight fire with normal precautions from a reasonable distance.

SPILL OR LEAK

- ELIMINATE all ignition sources (no smoking, flares, sparks or flames) from immediate area.
- All equipment used when handling the product must be grounded.
- Do not touch or walk through spilled material.
- **DO NOT OPERATE RADIO TRANSMITTERS WITHIN 100 METERS (330 FEET) OF ELECTRIC DETONATORS.**
- **DO NOT CLEAN-UP OR DISPOSE OF, EXCEPT UNDER SUPERVISION OF A SPECIALIST.**

FIRST AID

Refer to the "General First Aid" section.



In Canada, an Emergency Response Assistance Plan (ERAP) may be required for this product. Please consult the shipping paper and/or the "ERAP" section.

GUIDE 115 GASES - FLAMMABLE (INCLUDING REFRIGERATED LIQUIDS)

POTENTIAL HAZARDS

FIRE OR EXPLOSION

- **EXTREMELY FLAMMABLE.**

- Will be easily ignited by heat, sparks or flames.
- Will form explosive mixtures with air.
- Vapors from liquefied gas are initially heavier than air and spread along ground.

CAUTION: Hydrogen (UN1049), Deuterium (UN1957), Hydrogen, refrigerated liquid (UN1966), Methane (UN1971) and Hydrogen and Methane mixture, compressed (UN2034) are lighter than air and will rise. Hydrogen and Deuterium fires are difficult to detect since they burn with an invisible flame. Use an alternate method of detection (thermal camera, broom handle, etc.)

- Vapors may travel to source of ignition and flash back.
- Cylinders exposed to fire may vent and release flammable gas through pressure relief devices.
- Containers may explode when heated.
- Ruptured cylinders may rocket.

CAUTION: When LNG – Liquefied natural gas (UN1972) is released on or near water, product may vaporize explosively.

HEALTH

- Vapors may cause dizziness or asphyxiation without warning, especially when in closed or confined areas.
- Some may be irritating if inhaled at high concentrations.
- Contact with gas, liquefied gas or cryogenic liquids may cause burns, severe injury and/or frostbite.
- Fire may produce irritating and/or toxic gases.

PUBLIC SAFETY

- **CALL 911. Then call emergency response telephone number on shipping paper.** If shipping paper not available or no answer, refer to appropriate telephone number listed on the inside back cover.
- Keep unauthorized personnel away.
- Stay upwind, uphill and/or upstream.
- Many gases are heavier than air and will spread along the ground and collect in low or confined areas (sewers, basements, tanks, etc.).

PROTECTIVE CLOTHING

- Wear positive pressure self-contained breathing apparatus (SCBA).
- Structural firefighters' protective clothing provides thermal protection **but only limited chemical protection.**
- Always wear thermal protective clothing when handling refrigerated/cryogenic liquids.

EVACUATION

Immediate precautionary measure

- Isolate spill or leak area for at least 100 meters (330 feet) in all directions.

Large Spill

- Consider initial downwind evacuation for at least 800 meters (1/2 mile).

Fire

- If tank, rail tank car or highway tank is involved in a fire, ISOLATE for 1600 meters (1 mile) in all directions; also, consider initial evacuation for 1600 meters (1 mile) in all directions.
- In fires involving Liquefied Petroleum Gases (LPG) (UN1075), Butane (UN1011), Butylene (UN1012), Isobutylene (UN1055), Propylene (UN1077), Isobutane (UN1969), and Propane (UN1978), also refer to the "BLEVE – Safety Precautions" section.

EMERGENCY RESPONSE

FIRE

- **DO NOT EXTINGUISH A LEAKING GAS FIRE UNLESS LEAK CAN BE STOPPED.**

CAUTION: Hydrogen (UN1049), Deuterium (UN1957), Hydrogen, refrigerated liquid (UN1966) and Hydrogen and Methane mixture, compressed (UN2034) will burn with an invisible flame. Use an alternate method of detection (thermal camera, broom handle, etc.)

Small Fire

- Dry chemical or CO₂.

Large Fire

- Water spray or fog.
- If it can be done safely, move undamaged containers away from the area around the fire.

CAUTION: For LNG - Liquefied natural gas (UN1972) pool fires, DO NOT USE water. Use dry chemical or high-expansion foam.

Fire Involving Tanks

- Fight fire from maximum distance or use unmanned master stream devices or monitor nozzles.
- Cool containers with flooding quantities of water until well after fire is out.
- Do not direct water at source of leak or safety devices; icing may occur.
- Withdraw immediately in case of rising sound from venting safety devices or discoloration of tank.
- ALWAYS stay away from tanks in direct contact with flames.
- For massive fire, use unmanned master stream devices or monitor nozzles; if this is impossible, withdraw from area and let fire burn.

SPILL OR LEAK

- ELIMINATE all ignition sources (no smoking, flares, sparks or flames) from immediate area.
- All equipment used when handling the product must be grounded.
- Do not touch or walk through spilled material.
- Stop leak if you can do it without risk.
- If possible, turn leaking containers so that gas escapes rather than liquid.
- Use water spray to reduce vapors or divert vapor cloud drift. Avoid allowing water runoff to contact spilled material.
- Do not direct water at spill or source of leak.

CAUTION: For LNG - Liquefied natural gas (UN1972), DO NOT apply water, regular or alcohol-resistant foam directly on spill. Use a high-expansion foam if available to reduce vapors.

- Prevent spreading of vapors through sewers, ventilation systems and confined areas.
- Isolate area until gas has dispersed.

CAUTION: When in contact with refrigerated/cryogenic liquids, many materials become brittle and are likely to break without warning.

FIRST AID

Refer to the "General First Aid" section.

Specific First Aid:

- Clothing frozen to the skin should be thawed before being removed.
- In case of contact with liquefied gas, only medical personnel should attempt thawing frosted parts.
- In case of burns, immediately cool affected skin for as long as possible with cold water. Do not remove clothing if adhering to skin.



In Canada, an Emergency Response Assistance Plan (ERAP) may be required for this product. Please consult the shipping paper and/or the "ERAP" section.

POTENTIAL HAZARDS

FIRE OR EXPLOSION

- **EXTREMELY FLAMMABLE.**

- Will be easily ignited by heat, sparks or flames.
- Will form explosive mixtures with air. Acetylene (UN1001, UN3374) may react explosively even in the absence of air.
- Disilane (UN3553) and Silane (UN2203) will ignite spontaneously in air and may re-ignite.
- Those substances designated with a (P) may polymerize explosively when heated or involved in a fire.
- Vapors from liquefied gas are initially heavier than air and spread along ground.
- Vapors may travel to source of ignition and flash back.
- Cylinders exposed to fire may vent and release flammable gas through pressure relief devices.
- Containers may explode when heated.
- Ruptured cylinders may rocket.

HEALTH

- Vapors may cause dizziness or asphyxiation without warning, especially when in closed or confined areas.
- Some may be toxic if inhaled at high concentrations.
- Contact with gas or liquefied gas may cause burns, severe injury and/or frostbite.
- Fire may produce irritating and/or toxic gases.

PUBLIC SAFETY

- **CALL 911. Then call emergency response telephone number on shipping paper.** If shipping paper not available or no answer, refer to appropriate telephone number listed on the inside back cover.
- Keep unauthorized personnel away.
- Stay upwind, uphill and/or upstream.
- Many gases are heavier than air and will spread along the ground and collect in low or confined areas (sewers, basements, tanks, etc.).

PROTECTIVE CLOTHING

- Wear positive pressure self-contained breathing apparatus (SCBA).
- Structural firefighters' protective clothing provides thermal protection **but only limited chemical protection.**

EVACUATION

Immediate precautionary measure

- Isolate spill or leak area for at least 100 meters (330 feet) in all directions.

Large Spill

- Consider initial downwind evacuation for at least 800 meters (1/2 mile).

Fire

- If tank, rail tank car or highway tank is involved in a fire, ISOLATE for 1600 meters (1 mile) in all directions; also, consider initial evacuation for 1600 meters (1 mile) in all directions.

EMERGENCY RESPONSE

FIRE

- **DO NOT EXTINGUISH A LEAKING GAS FIRE UNLESS LEAK CAN BE STOPPED.**

Small Fire

- Dry chemical or CO₂.

Large Fire

- Water spray or fog.
- If it can be done safely, move undamaged containers away from the area around the fire.

Fire Involving Tanks

- Fight fire from maximum distance or use unmanned master stream devices or monitor nozzles.
- Cool containers with flooding quantities of water until well after fire is out.
- Do not direct water at source of leak or safety devices; icing may occur.
- Withdraw immediately in case of rising sound from venting safety devices or discoloration of tank.
- ALWAYS stay away from tanks in direct contact with flames.
- For massive fire, use unmanned master stream devices or monitor nozzles; if this is impossible, withdraw from area and let fire burn.

SPILL OR LEAK

- ELIMINATE all ignition sources (no smoking, flares, sparks or flames) from immediate area.
- All equipment used when handling the product must be grounded.
- Stop leak if you can do it without risk.
- Do not touch or walk through spilled material.
- Do not direct water at spill or source of leak.
- Use water spray to reduce vapors or divert vapor cloud drift. Avoid allowing water runoff to contact spilled material.
- If possible, turn leaking containers so that gas escapes rather than liquid.
- Prevent entry into waterways, sewers, basements or confined areas.
- Isolate area until gas has dispersed.

FIRST AID

Refer to the "General First Aid" section.

Specific First Aid:

- In case of contact with liquefied gas, only medical personnel should attempt thawing frosted parts.
- In case of burns, immediately cool affected skin for as long as possible with cold water. Do not remove clothing if adhering to skin.



In Canada, an Emergency Response Assistance Plan (ERAP) may be required for this product. Please consult the shipping paper and/or the "ERAP" section.

GUIDE 117 GASES - TOXIC - FLAMMABLE (EXTREME HAZARD)

POTENTIAL HAZARDS

HEALTH

- **TOXIC; Extremely Hazardous.**
- May be fatal if inhaled or absorbed through skin.
- Initial odor may be irritating or foul and may deaden your sense of smell.
- Contact with gas or liquefied gas may cause burns, severe injury and/or frostbite.
- Fire will produce irritating, corrosive and/or toxic gases.
- Runoff from fire control or dilution water may cause environmental contamination.

FIRE OR EXPLOSION

- These materials are extremely flammable.
- May form explosive mixtures with air.
- May be ignited by heat, sparks or flames.
- Vapors from liquefied gas are initially heavier than air and spread along ground.
- Vapors may travel to source of ignition and flash back.
- Those substances designated with a (P) may polymerize explosively when heated or involved in a fire.
- Runoff may create fire or explosion hazard.
- Cylinders exposed to fire may vent and release toxic and flammable gas through pressure relief devices.
- Containers may explode when heated.
- Ruptured cylinders may rocket.

PUBLIC SAFETY

- **CALL 911. Then call emergency response telephone number on shipping paper.** If shipping paper not available or no answer, refer to appropriate telephone number listed on the inside back cover.
- Keep unauthorized personnel away.
- Stay upwind, uphill and/or upstream.
- Many gases are heavier than air and will spread along the ground and collect in low or confined areas (sewers, basements, tanks, etc.).
- Ventilate closed spaces before entering, but only if properly trained and equipped.

PROTECTIVE CLOTHING

- Wear positive pressure self-contained breathing apparatus (SCBA).
- Wear chemical protective clothing that is specifically recommended by the manufacturer **when there is NO RISK OF FIRE.**
- Structural firefighters' protective clothing provides thermal protection **but only limited chemical protection.**

EVACUATION

Immediate precautionary measure

- Isolate spill or leak area for at least 100 meters (330 feet) in all directions.

Spill

- See [Table 1 - Initial Isolation and Protective Action Distances.](#)

Fire

- If tank, rail tank car or highway tank is involved in a fire, ISOLATE for 1600 meters (1 mile) in all directions; also, consider initial evacuation for 1600 meters (1 mile) in all directions.

EMERGENCY RESPONSE

FIRE

- **DO NOT EXTINGUISH A LEAKING GAS FIRE UNLESS LEAK CAN BE STOPPED.**

Small Fire

- Dry chemical, CO₂, water spray or regular foam.

Large Fire

- Water spray, fog or regular foam.
- If it can be done safely, move undamaged containers away from the area around the fire.
- Damaged cylinders should be handled only by specialists.

Fire Involving Tanks

- Fight fire from maximum distance or use unmanned master stream devices or monitor nozzles.
- Cool containers with flooding quantities of water until well after fire is out.
- Do not direct water at source of leak or safety devices; icing may occur.
- Withdraw immediately in case of rising sound from venting safety devices or discoloration of tank.
- ALWAYS stay away from tanks in direct contact with flames.

SPILL OR LEAK

- ELIMINATE all ignition sources (no smoking, flares, sparks or flames) from immediate area.
- All equipment used when handling the product must be grounded.
- Do not touch or walk through spilled material.
- Stop leak if you can do it without risk.
- Use water spray to reduce vapors or divert vapor cloud drift. Avoid allowing water runoff to contact spilled material.
- Do not direct water at spill or source of leak.
- If possible, turn leaking containers so that gas escapes rather than liquid.
- Prevent entry into waterways, sewers, basements or confined areas.
- Isolate area until gas has dispersed.
- Consider igniting spill or leak to eliminate toxic gas concerns.

FIRST AID

Refer to the "General First Aid" section.

Specific First Aid:

- In case of contact with liquefied gas, only medical personnel should attempt thawing frosted parts.
- In case of burns, immediately cool affected skin for as long as possible with cold water. Do not remove clothing if adhering to skin.



In Canada, an Emergency Response Assistance Plan (ERAP) may be required for this product. Please consult the shipping paper and/or the "ERAP" section.

POTENTIAL HAZARDS

FIRE OR EXPLOSION

- **EXTREMELY FLAMMABLE.**
- May be ignited by heat, sparks or flames.
- May form explosive mixtures with air.
- Vapors from liquefied gas are initially heavier than air and spread along ground.
- Vapors may travel to source of ignition and flash back.
- Some of these materials may react violently with water.
- Cylinders exposed to fire may vent and release flammable gas through pressure relief devices.
- Containers may explode when heated.
- Ruptured cylinders may rocket.

HEALTH

- May cause toxic effects if inhaled.
- Vapors are extremely irritating.
- Contact with gas or liquefied gas may cause burns, severe injury and/or frostbite.
- Fire will produce irritating, corrosive and/or toxic gases.
- Runoff from fire control or dilution water may cause environmental contamination.

PUBLIC SAFETY

- **CALL 911. Then call emergency response telephone number on shipping paper.** If shipping paper not available or no answer, refer to appropriate telephone number listed on the inside back cover.
- Keep unauthorized personnel away.
- Stay upwind, uphill and/or upstream.
- Many gases are heavier than air and will spread along the ground and collect in low or confined areas (sewers, basements, tanks, etc.).
- Ventilate closed spaces before entering, but only if properly trained and equipped.

PROTECTIVE CLOTHING

- Wear positive pressure self-contained breathing apparatus (SCBA).
- Wear chemical protective clothing that is specifically recommended by the manufacturer **when there is NO RISK OF FIRE.**
- Structural firefighters' protective clothing provides thermal protection **but only limited chemical protection.**

EVACUATION

Immediate precautionary measure

- Isolate spill or leak area for at least 100 meters (330 feet) in all directions.

Spill

- For **highlighted materials**: see Table 1 - Initial Isolation and Protective Action Distances.
- For non-highlighted materials: increase the immediate precautionary measure distance, in the downwind direction, as necessary.

Fire

- If tank, rail tank car or highway tank is involved in a fire, ISOLATE for 1600 meters (1 mile) in all directions; also, consider initial evacuation for 1600 meters (1 mile) in all directions.

EMERGENCY RESPONSE

FIRE

- **DO NOT EXTINGUISH A LEAKING GAS FIRE UNLESS LEAK CAN BE STOPPED.**

Small Fire

- Dry chemical or CO₂.

Large Fire

- Water spray, fog or regular foam.
- If it can be done safely, move undamaged containers away from the area around the fire.
- Damaged cylinders should be handled only by specialists.

Fire Involving Tanks

- Fight fire from maximum distance or use unmanned master stream devices or monitor nozzles.
- Cool containers with flooding quantities of water until well after fire is out.
- Do not direct water at source of leak or safety devices; icing may occur.
- Withdraw immediately in case of rising sound from venting safety devices or discoloration of tank.
- ALWAYS stay away from tanks in direct contact with flames.

SPILL OR LEAK

- ELIMINATE all ignition sources (no smoking, flares, sparks or flames) from immediate area.
- All equipment used when handling the product must be grounded.
- Do not touch or walk through spilled material.
- Stop leak if you can do it without risk.
- If possible, turn leaking containers so that gas escapes rather than liquid.
- Use water spray to reduce vapors or divert vapor cloud drift. Avoid allowing water runoff to contact spilled material.
- Do not direct water at spill or source of leak.
- Isolate area until gas has dispersed.

FIRST AID

Refer to the "General First Aid" section.

Specific First Aid:

- In case of contact with liquefied gas, only medical personnel should attempt thawing frosted parts.
- In case of burns, immediately cool affected skin for as long as possible with cold water. Do not remove clothing if adhering to skin.



In Canada, an Emergency Response Assistance Plan (ERAP) may be required for this product. Please consult the shipping paper and/or the "ERAP" section.

POTENTIAL HAZARDS

HEALTH

- **TOXIC; may be fatal if inhaled or absorbed through skin. Some may cause severe skin burns and eye damage.**
- Contact with gas or liquefied gas may cause burns, severe injury and/or frostbite.
- Fire will produce irritating, corrosive and/or toxic gases.
- Runoff from fire control or dilution water may cause environmental contamination.

FIRE OR EXPLOSION

- Flammable; may be ignited by heat, sparks or flames.
- May form explosive mixtures with air. Ethylene oxide (UN1040) may react explosively even in the absence of air.
- Those substances designated with a **(P)** may polymerize explosively when heated or involved in a fire.
- Vapors from liquefied gas are initially heavier than air and spread along ground.
- Vapors may travel to source of ignition and flash back.
- Some of these materials may react violently with water.
- Cylinders exposed to fire may vent and release toxic and flammable gas through pressure relief devices.
- Containers may explode when heated.
- Ruptured cylinders may rocket.
- Runoff may create fire or explosion hazard.

PUBLIC SAFETY

- **CALL 911. Then call emergency response telephone number on shipping paper.** If shipping paper not available or no answer, refer to appropriate telephone number listed on the inside back cover.
- Keep unauthorized personnel away.
- Stay upwind, uphill and/or upstream.
- Many gases are heavier than air and will spread along the ground and collect in low or confined areas (sewers, basements, tanks, etc.).
- Ventilate closed spaces before entering, but only if properly trained and equipped.

PROTECTIVE CLOTHING

- Wear positive pressure self-contained breathing apparatus (SCBA).
- Wear chemical protective clothing that is specifically recommended by the manufacturer **when there is NO RISK OF FIRE.**
- Structural firefighters' protective clothing provides thermal protection **but only limited chemical protection.**

EVACUATION

Immediate precautionary measure

- Isolate spill or leak area for at least 100 meters (330 feet) in all directions.

Spill

- For **highlighted materials**: see Table 1 - Initial Isolation and Protective Action Distances.
- For non-highlighted materials: increase the immediate precautionary measure distance, in the downwind direction, as necessary.

Fire

- If tank, rail tank car or highway tank is involved in a fire, ISOLATE for 1600 meters (1 mile) in all directions; also, consider initial evacuation for 1600 meters (1 mile) in all directions.

EMERGENCY RESPONSE

FIRE

- **DO NOT EXTINGUISH A LEAKING GAS FIRE UNLESS LEAK CAN BE STOPPED.**

Small Fire

- Dry chemical, CO₂, water spray or alcohol-resistant foam.

Large Fire

- Water spray, fog or alcohol-resistant foam.
- **FOR CHLOROSILANES, DO NOT USE WATER;** use alcohol-resistant foam.
- If it can be done safely, move undamaged containers away from the area around the fire.
- Damaged cylinders should be handled only by specialists.

Fire Involving Tanks

- Fight fire from maximum distance or use unmanned master stream devices or monitor nozzles.
- Cool containers with flooding quantities of water until well after fire is out.
- Do not direct water at source of leak or safety devices; icing may occur.
- Withdraw immediately in case of rising sound from venting safety devices or discoloration of tank.
- ALWAYS stay away from tanks in direct contact with flames.

SPILL OR LEAK

- ELIMINATE all ignition sources (no smoking, flares, sparks or flames) from immediate area.
- All equipment used when handling the product must be grounded.
- Do not touch or walk through spilled material.
- Stop leak if you can do it without risk.
- Do not direct water at spill or source of leak.
- Use water spray to reduce vapors or divert vapor cloud drift. Avoid allowing water runoff to contact spilled material.
- **FOR CHLOROSILANES,** use alcohol-resistant foam to reduce vapors.
- If possible, turn leaking containers so that gas escapes rather than liquid.
- Prevent entry into waterways, sewers, basements or confined areas.
- Isolate area until gas has dispersed.

FIRST AID

Refer to the "General First Aid" section.

Specific First Aid:

- In case of contact with liquefied gas, only medical personnel should attempt thawing frosted parts.
- In case of burns, immediately cool affected skin for as long as possible with cold water. Do not remove clothing if adhering to skin.



In Canada, an Emergency Response Assistance Plan (ERAP) may be required for this product. Please consult the shipping paper and/or the "ERAP" section.

POTENTIAL HAZARDS

HEALTH

- Vapors may cause dizziness or asphyxiation without warning, especially when in closed or confined areas.
- Vapors from liquefied gas are initially heavier than air and spread along ground.
- Contact with gas, liquefied gas or cryogenic liquids may cause burns, severe injury and/or frostbite.

FIRE OR EXPLOSION

- **Non-flammable gases.**
- Containers may explode when heated.
- Ruptured cylinders may rocket.

PUBLIC SAFETY

- **CALL 911. Then call emergency response telephone number on shipping paper.** If shipping paper not available or no answer, refer to appropriate telephone number listed on the inside back cover.
- Keep unauthorized personnel away.
- Stay upwind, uphill and/or upstream.
- Many gases are heavier than air and will spread along the ground and collect in low or confined areas (sewers, basements, tanks, etc.).
- Ventilate closed spaces before entering, but only if properly trained and equipped.

PROTECTIVE CLOTHING

- Wear positive pressure self-contained breathing apparatus (SCBA).
- Structural firefighters' protective clothing provides thermal protection **but only limited chemical protection.**
- Always wear thermal protective clothing when handling refrigerated/cryogenic liquids or solids.

EVACUATION

Immediate precautionary measure

- Isolate spill or leak area for at least 100 meters (330 feet) in all directions.

Large Spill

- Consider initial downwind evacuation for at least 100 meters (330 feet).

Fire

- If tank, rail tank car or highway tank is involved in a fire, ISOLATE for 800 meters (1/2 mile) in all directions; also, consider initial evacuation for 800 meters (1/2 mile) in all directions.

EMERGENCY RESPONSE

FIRE

- Use extinguishing agent suitable for type of surrounding fire.
- If it can be done safely, move undamaged containers away from the area around the fire.
- Damaged cylinders should be handled only by specialists.

Fire Involving Tanks

- Fight fire from maximum distance or use unmanned master stream devices or monitor nozzles.
- Cool containers with flooding quantities of water until well after fire is out.
- Do not direct water at source of leak or safety devices; icing may occur.
- Withdraw immediately in case of rising sound from venting safety devices or discoloration of tank.
- ALWAYS stay away from tanks in direct contact with flames.

SPILL OR LEAK

- Do not touch or walk through spilled material.
- Stop leak if you can do it without risk.
- Use water spray to reduce vapors or divert vapor cloud drift. Avoid allowing water runoff to contact spilled material.
- Do not direct water at spill or source of leak.
- If possible, turn leaking containers so that gas escapes rather than liquid.
- Prevent entry into waterways, sewers, basements or confined areas.
- Allow substance to evaporate.
- Ventilate the area.

CAUTION: When in contact with refrigerated/cryogenic liquids, many materials become brittle and are likely to break without warning.

FIRST AID

Refer to the “General First Aid” section.

Specific First Aid:

- Clothing frozen to the skin should be thawed before being removed.
- In case of contact with liquefied gas, only medical personnel should attempt thawing frosted parts.

Intentionally left blank

There are no materials that refer to this guide.

Intentionally left blank

There are no materials that refer to this guide.

GUIDE 122

GASES - OXIDIZING (INCLUDING REFRIGERATED LIQUIDS)

POTENTIAL HAZARDS

FIRE OR EXPLOSION

- Substance does not burn but will support combustion.
- Some may react explosively with fuels.
- May ignite combustibles (wood, paper, oil, clothing, etc.).
- Vapors from liquefied gas are initially heavier than air and spread along ground.
- Runoff may create fire or explosion hazard.
- Containers may explode when heated.
- Ruptured cylinders may rocket.

HEALTH

- Vapors may cause dizziness or asphyxiation without warning, especially when in closed or confined areas.
- Contact with gas, liquefied gas or cryogenic liquids may cause burns, severe injury and/or frostbite.
- Fire may produce irritating and/or toxic gases.

PUBLIC SAFETY

- **CALL 911. Then call emergency response telephone number on shipping paper.** If shipping paper not available or no answer, refer to appropriate telephone number listed on the inside back cover.
- Keep unauthorized personnel away.
- Stay upwind, uphill and/or upstream.
- Many gases are heavier than air and will spread along the ground and collect in low or confined areas (sewers, basements, tanks, etc.).
- Ventilate closed spaces before entering, but only if properly trained and equipped.

PROTECTIVE CLOTHING

- Wear positive pressure self-contained breathing apparatus (SCBA).
- Wear chemical protective clothing that is specifically recommended by the manufacturer **when there is NO RISK OF FIRE.**
- Structural firefighters' protective clothing provides thermal protection **but only limited chemical protection.**
- Always wear thermal protective clothing when handling refrigerated/cryogenic liquids.

EVACUATION

Immediate precautionary measure

- Isolate spill or leak area for at least 100 meters (330 feet) in all directions.

Large Spill

- Consider initial downwind evacuation for at least 500 meters (1/3 mile).

Fire

- If tank, rail tank car or highway tank is involved in a fire, ISOLATE for 800 meters (1/2 mile) in all directions; also, consider initial evacuation for 800 meters (1/2 mile) in all directions.

EMERGENCY RESPONSE

FIRE

- Use extinguishing agent suitable for type of surrounding fire.

Small Fire

- Dry chemical or CO₂.

Large Fire

- Water spray, fog or regular foam.
- If it can be done safely, move undamaged containers away from the area around the fire.
- Damaged cylinders should be handled only by specialists.

Fire Involving Tanks

- Fight fire from maximum distance or use unmanned master stream devices or monitor nozzles.
- Cool containers with flooding quantities of water until well after fire is out.
- Do not direct water at source of leak or safety devices; icing may occur.
- Withdraw immediately in case of rising sound from venting safety devices or discoloration of tank.
- ALWAYS stay away from tanks in direct contact with flames.
- For massive fire, use unmanned master stream devices or monitor nozzles; if this is impossible, withdraw from area and let fire burn.

SPILL OR LEAK

- Keep combustibles (wood, paper, oil, etc.) away from spilled material.
- Do not touch or walk through spilled material.
- Stop leak if you can do it without risk.
- If possible, turn leaking containers so that gas escapes rather than liquid.
- Do not direct water at spill or source of leak.
- Use water spray to reduce vapors or divert vapor cloud drift. Avoid allowing water runoff to contact spilled material.
- Prevent entry into waterways, sewers, basements or confined areas.
- Allow substance to evaporate.
- Isolate area until gas has dispersed.

CAUTION: When in contact with refrigerated/cryogenic liquids, many materials become brittle and are likely to break without warning.

FIRST AID

Refer to the "General First Aid" section.

Specific First Aid:

- Clothing frozen to the skin should be thawed before being removed.
- In case of contact with liquefied gas, only medical personnel should attempt thawing frosted parts.



In Canada, an Emergency Response Assistance Plan (ERAP) may be required for this product. Please consult the shipping paper and/or the "ERAP" section.

POTENTIAL HAZARDS

HEALTH

- **TOXIC; may be fatal if inhaled or absorbed through skin.**
- Vapors may be irritating and/or corrosive.
- Contact with gas or liquefied gas may cause burns, severe injury and/or frostbite.
- Fire will produce irritating, corrosive and/or toxic gases.
- Runoff from fire control or dilution water may cause environmental contamination.

FIRE OR EXPLOSION

- Some may burn but none ignite readily.
- Vapors from liquefied gas are initially heavier than air and spread along ground.
- Cylinders exposed to fire may vent and release toxic and/or corrosive gas through pressure relief devices.
- Containers may explode when heated.
- Ruptured cylinders may rocket.

PUBLIC SAFETY

- **CALL 911. Then call emergency response telephone number on shipping paper.** If shipping paper not available or no answer, refer to appropriate telephone number listed on the inside back cover.
- Keep unauthorized personnel away.
- Stay upwind, uphill and/or upstream.
- Many gases are heavier than air and will spread along the ground and collect in low or confined areas (sewers, basements, tanks, etc.).
- Ventilate closed spaces before entering, but only if properly trained and equipped.

PROTECTIVE CLOTHING

- Wear positive pressure self-contained breathing apparatus (SCBA).
- Wear chemical protective clothing that is specifically recommended by the manufacturer **when there is NO RISK OF FIRE.**
- Structural firefighters' protective clothing provides thermal protection **but only limited chemical protection.**

EVACUATION

Immediate precautionary measure

- Isolate spill or leak area for at least 100 meters (330 feet) in all directions.

Spill

- For **highlighted materials**: see Table 1 - Initial Isolation and Protective Action Distances.
- For non-highlighted materials: increase the immediate precautionary measure distance, in the downwind direction, as necessary.

Fire

- If tank, rail tank car or highway tank is involved in a fire, ISOLATE for 800 meters (1/2 mile) in all directions; also, consider initial evacuation for 800 meters (1/2 mile) in all directions.

EMERGENCY RESPONSE**FIRE****Small Fire**

- Dry chemical or CO₂.

Large Fire

- Water spray, fog or regular foam.
- Do not get water inside containers.
- If it can be done safely, move undamaged containers away from the area around the fire.
- Damaged cylinders should be handled only by specialists.

Fire Involving Tanks

- Fight fire from maximum distance or use unmanned master stream devices or monitor nozzles.
- Cool containers with flooding quantities of water until well after fire is out.
- Do not direct water at source of leak or safety devices; icing may occur.
- Withdraw immediately in case of rising sound from venting safety devices or discoloration of tank.
- ALWAYS stay away from tanks in direct contact with flames.

SPILL OR LEAK

- Do not touch or walk through spilled material.
- Stop leak if you can do it without risk.
- If possible, turn leaking containers so that gas escapes rather than liquid.
- Prevent entry into waterways, sewers, basements or confined areas.
- Use water spray to reduce vapors or divert vapor cloud drift. Avoid allowing water runoff to contact spilled material.
- Do not direct water at spill or source of leak.
- Isolate area until gas has dispersed.

FIRST AID

Refer to the "General First Aid" section.

Specific First Aid:

- In case of contact with liquefied gas, only medical personnel should attempt thawing frosted parts.



In Canada, an Emergency Response Assistance Plan (ERAP) may be required for this product. Please consult the shipping paper and/or the "ERAP" section.

POTENTIAL HAZARDS

HEALTH

- **TOXIC and/or CORROSIVE; may be fatal if inhaled or absorbed through skin.**
- Fire will produce irritating, corrosive and/or toxic gases.
- Contact with gas or liquefied gas may cause burns, severe injury and/or frostbite.
- Runoff from fire control or dilution water may cause environmental contamination.

FIRE OR EXPLOSION

- Substance does not burn but will support combustion.
- Vapors from liquefied gas are initially heavier than air and spread along ground.
- These are strong oxidizers and will react vigorously or explosively with many materials including fuels.
- May ignite combustibles (wood, paper, oil, clothing, etc.).
- Some will react violently with air, moist air and/or water.
- Cylinders exposed to fire may vent and release toxic and/or corrosive gas through pressure relief devices.
- Containers may explode when heated.
- Ruptured cylinders may rocket.

PUBLIC SAFETY

- **CALL 911. Then call emergency response telephone number on shipping paper.** If shipping paper not available or no answer, refer to appropriate telephone number listed on the inside back cover.
- Keep unauthorized personnel away.
- Stay upwind, uphill and/or upstream.
- Many gases are heavier than air and will spread along the ground and collect in low or confined areas (sewers, basements, tanks, etc.).
- Ventilate closed spaces before entering, but only if properly trained and equipped.

PROTECTIVE CLOTHING

- Wear positive pressure self-contained breathing apparatus (SCBA).
- Wear chemical protective clothing that is specifically recommended by the manufacturer **when there is NO RISK OF FIRE.**
- Structural firefighters' protective clothing provides thermal protection **but only limited chemical protection.**

EVACUATION

Immediate precautionary measure

- Isolate spill or leak area for at least 100 meters (330 feet) in all directions.

Spill

- See **Table 1 - Initial Isolation and Protective Action Distances.**

Fire

- If tank, rail tank car or highway tank is involved in a fire, ISOLATE for 800 meters (1/2 mile) in all directions; also, consider initial evacuation for 800 meters (1/2 mile) in all directions.

EMERGENCY RESPONSE

FIRE

CAUTION: These materials do not burn but will support combustion. Some will react violently with water.

Small Fire

- Contain fire and let burn. If fire must be fought, water spray or fog is recommended.
- **Water only; no dry chemical, CO₂ or Halon®.**
- Do not get water inside containers.
- If it can be done safely, move undamaged containers away from the area around the fire.
- Damaged cylinders should be handled only by specialists.

Fire Involving Tanks

- Fight fire from maximum distance or use unmanned master stream devices or monitor nozzles.
- Cool containers with flooding quantities of water until well after fire is out.
- Do not direct water at source of leak or safety devices; icing may occur.
- Withdraw immediately in case of rising sound from venting safety devices or discoloration of tank.
- ALWAYS stay away from tanks in direct contact with flames.
- For massive fire, use unmanned master stream devices or monitor nozzles; if this is impossible, withdraw from area and let fire burn.

SPILL OR LEAK

- Do not touch or walk through spilled material.
- Keep combustibles (wood, paper, oil, etc.) away from spilled material.
- Stop leak if you can do it without risk.
- Use water spray to reduce vapors or divert vapor cloud drift. Avoid allowing water runoff to contact spilled material.
- Do not direct water at spill or source of leak.
- If possible, turn leaking containers so that gas escapes rather than liquid.
- Prevent entry into waterways, sewers, basements or confined areas.
- Isolate area until gas has dispersed.
- Ventilate the area.

FIRST AID

Refer to the “General First Aid” section.

Specific First Aid:

- Clothing frozen to the skin should be thawed before being removed.



In Canada, an Emergency Response Assistance Plan (ERAP) may be required for this product. Please consult the shipping paper and/or the "ERAP" section.

GUIDE GASES - TOXIC AND/OR CORROSIVE

125

POTENTIAL HAZARDS

HEALTH

- **TOXIC and/or CORROSIVE; may be fatal if inhaled, ingested or absorbed through skin.**
- Vapors are extremely irritating and corrosive.
- Contact with gas or liquefied gas may cause burns, severe injury and/or frostbite.
- Fire will produce irritating, corrosive and/or toxic gases.
- Runoff from fire control or dilution water may cause environmental contamination.

FIRE OR EXPLOSION

- Some may burn but none ignite readily.
- Vapors from liquefied gas are initially heavier than air and spread along ground.
- Some of these materials may react violently with water.
- Cylinders exposed to fire may vent and release toxic and/or corrosive gas through pressure relief devices.
- Containers may explode when heated.
- Ruptured cylinders may rocket.
- For UN1005: Anhydrous ammonia, at high concentrations in confined spaces, presents a flammability risk if a source of ignition is introduced.

PUBLIC SAFETY

- **CALL 911. Then call emergency response telephone number on shipping paper.** If shipping paper not available or no answer, refer to appropriate telephone number listed on the inside back cover.
- Keep unauthorized personnel away.
- Stay upwind, uphill and/or upstream.
- Many gases are heavier than air and will spread along the ground and collect in low or confined areas (sewers, basements, tanks, etc.).
- Ventilate closed spaces before entering, but only if properly trained and equipped.

PROTECTIVE CLOTHING

- Wear positive pressure self-contained breathing apparatus (SCBA).
- Wear chemical protective clothing that is specifically recommended by the manufacturer **when there is NO RISK OF FIRE.**
- Structural firefighters' protective clothing provides thermal protection **but only limited chemical protection.**

EVACUATION

Immediate precautionary measure

- Isolate spill or leak area for at least 100 meters (330 feet) in all directions.

Spill

- For **highlighted materials**: see Table 1 - Initial Isolation and Protective Action Distances.
- For non-highlighted materials: increase the immediate precautionary measure distance, in the downwind direction, as necessary.

Fire

- If tank, rail tank car or highway tank is involved in a fire, ISOLATE for 1600 meters (1 mile) in all directions; also, consider initial evacuation for 1600 meters (1 mile) in all directions.

EMERGENCY RESPONSE

FIRE**Small Fire**

- Dry chemical or CO₂.

Large Fire

- Water spray, fog or regular foam.
- If it can be done safely, move undamaged containers away from the area around the fire.
- Do not get water inside containers.
- Damaged cylinders should be handled only by specialists.

Fire Involving Tanks

- Fight fire from maximum distance or use unmanned master stream devices or monitor nozzles.
- Cool containers with flooding quantities of water until well after fire is out.
- Do not direct water at source of leak or safety devices; icing may occur.
- Withdraw immediately in case of rising sound from venting safety devices or discoloration of tank.
- ALWAYS stay away from tanks in direct contact with flames.

SPILL OR LEAK

- Do not touch or walk through spilled material.
- Stop leak if you can do it without risk.
- If possible, turn leaking containers so that gas escapes rather than liquid.
- Prevent entry into waterways, sewers, basements or confined areas.
- Do not direct water at spill or source of leak.
- Use water spray to reduce vapors or divert vapor cloud drift. Avoid allowing water runoff to contact spilled material.
- Isolate area until gas has dispersed.

FIRST AID

Refer to the "General First Aid" section.

Specific First Aid:

- In case of contact with liquefied gas, only medical personnel should attempt thawing frosted parts.
- In case of skin contact with hydrogen fluoride, anhydrous (UN1052), if calcium gluconate gel is available, rinse 5 minutes, then apply gel. Otherwise, continue rinsing until medical treatment is available.



In Canada, an Emergency Response Assistance Plan (ERAP) may be required for this product. Please consult the shipping paper and/or the "ERAP" section.

GUIDE 126 GASES - COMPRESSED OR LIQUEFIED (INCLUDING REFRIGERANT GASES)

POTENTIAL HAZARDS

FIRE OR EXPLOSION

- Some may burn but none ignite readily.
- Containers may explode when heated.
- Ruptured cylinders may rocket.

CAUTION: Aerosols (UN1950) may contain a flammable propellant.

HEALTH

- Vapors may cause dizziness or asphyxiation without warning, especially when in closed or confined areas.
- Vapors from liquefied gas are initially heavier than air and spread along ground.
- Contact with gas or liquefied gas may cause burns, severe injury and/or frostbite.
- Fire may produce irritating, corrosive and/or toxic gases.

PUBLIC SAFETY

- **CALL 911. Then call emergency response telephone number on shipping paper.** If shipping paper not available or no answer, refer to appropriate telephone number listed on the inside back cover.
- Keep unauthorized personnel away.
- Stay upwind, uphill and/or upstream.
- Many gases are heavier than air and will spread along the ground and collect in low or confined areas (sewers, basements, tanks, etc.).
- Ventilate closed spaces before entering, but only if properly trained and equipped.

PROTECTIVE CLOTHING

- Wear positive pressure self-contained breathing apparatus (SCBA).
- Wear chemical protective clothing that is specifically recommended by the manufacturer **when there is NO RISK OF FIRE.**
- Structural firefighters' protective clothing provides thermal protection **but only limited chemical protection.**

EVACUATION

Immediate precautionary measure

- Isolate spill or leak area for at least 100 meters (330 feet) in all directions.

Large Spill

- Consider initial downwind evacuation for at least 500 meters (1/3 mile).

Fire

- If tank, rail tank car or highway tank is involved in a fire, ISOLATE for 800 meters (1/2 mile) in all directions; also, consider initial evacuation for 800 meters (1/2 mile) in all directions.

EMERGENCY RESPONSE

FIRE

- Use extinguishing agent suitable for type of surrounding fire.

Small Fire

- Dry chemical or CO₂.

Large Fire

- Water spray, fog or regular foam.
- If it can be done safely, move undamaged containers away from the area around the fire.
- Damaged cylinders should be handled only by specialists.

Fire Involving Tanks

- Fight fire from maximum distance or use unmanned master stream devices or monitor nozzles.
- Cool containers with flooding quantities of water until well after fire is out.
- Do not direct water at source of leak or safety devices; icing may occur.
- Withdraw immediately in case of rising sound from venting safety devices or discoloration of tank.
- ALWAYS stay away from tanks in direct contact with flames.
- Some of these materials, if spilled, may evaporate leaving a flammable residue.

SPILL OR LEAK

- Do not touch or walk through spilled material.
- Stop leak if you can do it without risk.
- Do not direct water at spill or source of leak.
- Use water spray to reduce vapors or divert vapor cloud drift. Avoid allowing water runoff to contact spilled material.
- If possible, turn leaking containers so that gas escapes rather than liquid.
- Prevent entry into waterways, sewers, basements or confined areas.
- Allow substance to evaporate.
- Ventilate the area.

FIRST AID

Refer to the "General First Aid" section.

Specific First Aid:

- In case of contact with liquefied gas, only medical personnel should attempt thawing frosted parts.

GUIDE 127

FLAMMABLE LIQUIDS (WATER-MISCIBLE)

POTENTIAL HAZARDS

FIRE OR EXPLOSION

- **HIGHLY FLAMMABLE:** Will be easily ignited by heat, sparks or flames.

CAUTION: Ethanol (UN1170) can burn with an invisible flame. Use an alternate method of detection (thermal camera, broom handle, etc.)

- Vapors may form explosive mixtures with air.
- Vapors may travel to source of ignition and flash back.
- Most vapors are heavier than air. They will spread along the ground and collect in low or confined areas (sewers, basements, tanks, etc.).
- Vapor explosion hazard indoors, outdoors or in sewers.
- Those substances designated with a (P) may polymerize explosively when heated or involved in a fire.
- Runoff to sewer may create fire or explosion hazard.
- Containers may explode when heated.
- Many liquids will float on water.

HEALTH

- Inhalation or contact with material may irritate or burn skin and eyes.
- Fire may produce irritating, corrosive and/or toxic gases.
- Vapors may cause dizziness or asphyxiation, especially when in closed or confined areas.
- Runoff from fire control or dilution water may cause environmental contamination.

PUBLIC SAFETY

- **CALL 911. Then call emergency response telephone number on shipping paper.** If shipping paper not available or no answer, refer to appropriate telephone number listed on the inside back cover.
- Keep unauthorized personnel away.
- Stay upwind, uphill and/or upstream.
- Ventilate closed spaces before entering, but only if properly trained and equipped.

PROTECTIVE CLOTHING

- Wear positive pressure self-contained breathing apparatus (SCBA).
- Structural firefighters' protective clothing provides thermal protection **but only limited chemical protection.**

EVACUATION

Immediate precautionary measure

- Isolate spill or leak area for at least 50 meters (150 feet) in all directions.

Large Spill

- Consider initial downwind evacuation for at least 300 meters (1000 feet).

Fire

- If tank, rail tank car or highway tank is involved in a fire, ISOLATE for 800 meters (1/2 mile) in all directions; also, consider initial evacuation for 800 meters (1/2 mile) in all directions.

EMERGENCY RESPONSE

FIRE

CAUTION: The majority of these products have a very low flash point. Use of water spray when fighting fire may be inefficient.

CAUTION: For fire involving UN1170, UN1987 or UN3475, alcohol-resistant foam should be used.

CAUTION: Ethanol (UN1170) can burn with an invisible flame. Use an alternate method of detection (thermal camera, broom handle, etc.)

Small Fire

- Dry chemical, CO₂, water spray or alcohol-resistant foam.

Large Fire

- Water spray, fog or alcohol-resistant foam.
- Avoid aiming straight or solid streams directly onto the product.
- If it can be done safely, move undamaged containers away from the area around the fire.

Fire Involving Tanks, Rail Tank Cars or Highway Tanks

- Fight fire from maximum distance or use unmanned master stream devices or monitor nozzles.
- Cool containers with flooding quantities of water until well after fire is out.
- Withdraw immediately in case of rising sound from venting safety devices or discoloration of tank.
- ALWAYS stay away from tanks in direct contact with flames.
- For massive fire, use unmanned master stream devices or monitor nozzles; if this is impossible, withdraw from area and let fire burn.

SPILL OR LEAK

- ELIMINATE all ignition sources (no smoking, flares, sparks or flames) from immediate area.
- All equipment used when handling the product must be grounded.
- Do not touch or walk through spilled material.
- Stop leak if you can do it without risk.
- Prevent entry into waterways, sewers, basements or confined areas.
- A vapor-suppressing foam may be used to reduce vapors.
- Absorb or cover with dry earth, sand or other non-combustible material and transfer to containers.
- Use clean, non-sparking tools to collect absorbed material.

Large Spill

- Dike far ahead of liquid spill for later disposal.
- Water spray may reduce vapor, but may not prevent ignition in closed spaces.

FIRST AID

Refer to the "General First Aid" section.

Specific First Aid:

- Wash skin with soap and water.
- In case of burns, immediately cool affected skin for as long as possible with cold water. Do not remove clothing if adhering to skin.



In Canada, an Emergency Response Assistance Plan (ERAP) may be required for this product. Please consult the shipping paper and/or the "ERAP" section.

GUIDE 128

FLAMMABLE LIQUIDS (WATER-IMMISCIBLE)

POTENTIAL HAZARDS

FIRE OR EXPLOSION

- **HIGHLY FLAMMABLE:** Will be easily ignited by heat, sparks or flames.
- Vapors may form explosive mixtures with air.
- Vapors may travel to source of ignition and flash back.
- Most vapors are heavier than air. They will spread along the ground and collect in low or confined areas (sewers, basements, tanks, etc.).
- Vapor explosion hazard indoors, outdoors or in sewers.
- Those substances designated with a (P) may polymerize explosively when heated or involved in a fire.
- Runoff to sewer may create fire or explosion hazard.
- Containers may explode when heated.
- Many liquids will float on water.
- Substance may be transported hot.
- For hybrid vehicles, GUIDE 147 (lithium ion or sodium ion batteries) or GUIDE 138 (sodium batteries) should also be consulted.
- **If molten aluminum is involved, refer to GUIDE 169.**

HEALTH

CAUTION: Petroleum crude oil (UN1267) may contain **TOXIC** hydrogen sulphide gas.

- Inhalation or contact with material may irritate or burn skin and eyes.
- Fire may produce irritating, corrosive and/or toxic gases.
- Vapors may cause dizziness or asphyxiation, especially when in closed or confined areas.
- Runoff from fire control or dilution water may cause environmental contamination.

PUBLIC SAFETY

- **CALL 911. Then call emergency response telephone number on shipping paper.** If shipping paper not available or no answer, refer to appropriate telephone number listed on the inside back cover.
- Keep unauthorized personnel away.
- Stay upwind, uphill and/or upstream.
- Ventilate closed spaces before entering, but only if properly trained and equipped.

PROTECTIVE CLOTHING

- Wear positive pressure self-contained breathing apparatus (SCBA).
- Structural firefighters' protective clothing provides thermal protection **but only limited chemical protection.**

EVACUATION

Immediate precautionary measure

- Isolate spill or leak area for at least 50 meters (150 feet) in all directions.

Large Spill

- Consider initial downwind evacuation for at least 300 meters (1000 feet).

Fire

- If tank, rail tank car or highway tank is involved in a fire, ISOLATE for 800 meters (1/2 mile) in all directions; also, consider initial evacuation for 800 meters (1/2 mile) in all directions.

EMERGENCY RESPONSE

FIRE

CAUTION: The majority of these products have a very low flash point. Use of water spray when fighting fire may be inefficient.

CAUTION: For mixtures containing alcohol or polar solvent, alcohol-resistant foam may be more effective.

Small Fire

- Dry chemical, CO₂, water spray or regular foam. If regular foam is ineffective or unavailable, use alcohol-resistant foam.

Large Fire

- Water spray, fog or regular foam. If regular foam is ineffective or unavailable, use alcohol-resistant foam.
- Avoid aiming straight or solid streams directly onto the product.
- If it can be done safely, move undamaged containers away from the area around the fire.

Fire Involving Tanks, Rail Tank Cars or Highway Tanks

- Fight fire from maximum distance or use unmanned master stream devices or monitor nozzles.
- Cool containers with flooding quantities of water until well after fire is out.
- For petroleum crude oil, do not spray water directly into a breached tank car. This can lead to a dangerous boil over.
- Withdraw immediately in case of rising sound from venting safety devices or discoloration of tank.
- ALWAYS stay away from tanks in direct contact with flames.
- For massive fire, use unmanned master stream devices or monitor nozzles; if this is impossible, withdraw from area and let fire burn.

SPILL OR LEAK

- ELIMINATE all ignition sources (no smoking, flares, sparks or flames) from immediate area.
- All equipment used when handling the product must be grounded.
- Do not touch or walk through spilled material.
- Stop leak if you can do it without risk.
- Prevent entry into waterways, sewers, basements or confined areas.
- A vapor-suppressing foam may be used to reduce vapors.
- Absorb or cover with dry earth, sand or other non-combustible material and transfer to containers.
- Use clean, non-sparking tools to collect absorbed material.

Large Spill

- Dike far ahead of liquid spill for later disposal.
- Water spray may reduce vapor, but may not prevent ignition in closed spaces.

FIRST AID

Refer to the "General First Aid" section.

Specific First Aid:

- Wash skin with soap and water.
- In case of burns, immediately cool affected skin for as long as possible with cold water. Do not remove clothing if adhering to skin.



In Canada, an Emergency Response Assistance Plan (ERAP) may be required for this product. Please consult the shipping paper and/or the "ERAP" section.

GUIDE 129

FLAMMABLE LIQUIDS (WATER-MISCIBLE/NOXIOUS)

POTENTIAL HAZARDS

FIRE OR EXPLOSION

- **HIGHLY FLAMMABLE: Will be easily ignited by heat, sparks or flames.**
- Vapors may form explosive mixtures with air.
- Vapors may travel to source of ignition and flash back.
- Most vapors are heavier than air. They will spread along the ground and collect in low or confined areas (sewers, basements, tanks, etc.).
- Vapor explosion hazard indoors, outdoors or in sewers.
- Those substances designated with a (P) may polymerize explosively when heated or involved in a fire.
- Runoff to sewer may create fire or explosion hazard.
- Containers may explode when heated.
- Many liquids will float on water.

HEALTH

- May cause toxic effects if inhaled or absorbed through skin.
- Inhalation or contact with material may irritate or burn skin and eyes.
- Fire will produce irritating, corrosive and/or toxic gases.
- Vapors may cause dizziness or asphyxiation, especially when in closed or confined areas.
- Runoff from fire control or dilution water may cause environmental contamination.

PUBLIC SAFETY

- **CALL 911. Then call emergency response telephone number on shipping paper.** If shipping paper not available or no answer, refer to appropriate telephone number listed on the inside back cover.
- Keep unauthorized personnel away.
- Stay upwind, uphill and/or upstream.
- Ventilate closed spaces before entering, but only if properly trained and equipped.

PROTECTIVE CLOTHING

- Wear positive pressure self-contained breathing apparatus (SCBA).
- Structural firefighters' protective clothing provides thermal protection **but only limited chemical protection.**

EVACUATION

Immediate precautionary measure

- Isolate spill or leak area for at least 50 meters (150 feet) in all directions.

Large Spill

- Consider initial downwind evacuation for at least 300 meters (1000 feet).

Fire

- If tank, rail tank car or highway tank is involved in a fire, ISOLATE for 800 meters (1/2 mile) in all directions; also, consider initial evacuation for 800 meters (1/2 mile) in all directions.

EMERGENCY RESPONSE

FIRE

CAUTION: The majority of these products have a very low flash point. Use of water spray when fighting fire may be inefficient.

Small Fire

- Dry chemical, CO₂, water spray or alcohol-resistant foam.
- **Do not use dry chemical extinguishers to control fires involving nitromethane (UN1261) or nitroethane (UN2842).**

Large Fire

- Water spray, fog or alcohol-resistant foam.
- Avoid aiming straight or solid streams directly onto the product.
- If it can be done safely, move undamaged containers away from the area around the fire.

Fire Involving Tanks, Rail Tank Cars or Highway Tanks

- Fight fire from maximum distance or use unmanned master stream devices or monitor nozzles.
- Cool containers with flooding quantities of water until well after fire is out.
- Withdraw immediately in case of rising sound from venting safety devices or discoloration of tank.
- ALWAYS stay away from tanks in direct contact with flames.
- For massive fire, use unmanned master stream devices or monitor nozzles; if this is impossible, withdraw from area and let fire burn.

SPILL OR LEAK

- ELIMINATE all ignition sources (no smoking, flares, sparks or flames) from immediate area.
- All equipment used when handling the product must be grounded.
- Do not touch or walk through spilled material.
- Stop leak if you can do it without risk.
- Prevent entry into waterways, sewers, basements or confined areas.
- A vapor-suppressing foam may be used to reduce vapors.
- Absorb or cover with dry earth, sand or other non-combustible material and transfer to containers.
- Use clean, non-sparking tools to collect absorbed material.

Large Spill

- Dike far ahead of liquid spill for later disposal.
- Water spray may reduce vapor, but may not prevent ignition in closed spaces.

FIRST AID

Refer to the "General First Aid" section.

Specific First Aid:

- Wash skin with soap and water.
- In case of burns, immediately cool affected skin for as long as possible with cold water. Do not remove clothing if adhering to skin.



In Canada, an Emergency Response Assistance Plan (ERAP) may be required for this product. Please consult the shipping paper and/or the "ERAP" section.

GUIDE 130 FLAMMABLE LIQUIDS (WATER-IMMISCIBLE/NOXIOUS)

POTENTIAL HAZARDS

FIRE OR EXPLOSION

- **HIGHLY FLAMMABLE: Will be easily ignited by heat, sparks or flames.**
- Vapors may form explosive mixtures with air.
- Vapors may travel to source of ignition and flash back.
- Most vapors are heavier than air. They will spread along the ground and collect in low or confined areas (sewers, basements, tanks, etc.).
- Vapor explosion hazard indoors, outdoors or in sewers.
- Those substances designated with a (P) may polymerize explosively when heated or involved in a fire.
- Runoff to sewer may create fire or explosion hazard.
- Containers may explode when heated.
- Many liquids will float on water.

HEALTH

- May cause toxic effects if inhaled or absorbed through skin.
- Inhalation or contact with material may irritate or burn skin and eyes.
- Fire will produce irritating, corrosive and/or toxic gases.
- Vapors may cause dizziness or asphyxiation, especially when in closed or confined areas.
- Runoff from fire control or dilution water may cause environmental contamination.

PUBLIC SAFETY

- **CALL 911. Then call emergency response telephone number on shipping paper.** If shipping paper not available or no answer, refer to appropriate telephone number listed on the inside back cover.
- Keep unauthorized personnel away.
- Stay upwind, uphill and/or upstream.
- Ventilate closed spaces before entering, but only if properly trained and equipped.

PROTECTIVE CLOTHING

- Wear positive pressure self-contained breathing apparatus (SCBA).
- Structural firefighters' protective clothing provides thermal protection **but only limited chemical protection.**

EVACUATION

Immediate precautionary measure

- Isolate spill or leak area for at least 50 meters (150 feet) in all directions.

Large Spill

- Consider initial downwind evacuation for at least 300 meters (1000 feet).

Fire

- If tank, rail tank car or highway tank is involved in a fire, ISOLATE for 800 meters (1/2 mile) in all directions; also, consider initial evacuation for 800 meters (1/2 mile) in all directions.

EMERGENCY RESPONSE

FIRE

CAUTION: The majority of these products have a very low flash point. Use of water spray when fighting fire may be inefficient.

Small Fire

- Dry chemical, CO₂, water spray or regular foam. If regular foam is ineffective or unavailable, use alcohol-resistant foam.

Large Fire

- Water spray, fog or regular foam. If regular foam is ineffective or unavailable, use alcohol-resistant foam.
- Avoid aiming straight or solid streams directly onto the product.
- If it can be done safely, move undamaged containers away from the area around the fire.

Fire Involving Tanks, Rail Tank Cars or Highway Tanks

- Fight fire from maximum distance or use unmanned master stream devices or monitor nozzles.
- Cool containers with flooding quantities of water until well after fire is out.
- Withdraw immediately in case of rising sound from venting safety devices or discoloration of tank.
- ALWAYS stay away from tanks in direct contact with flames.
- For massive fire, use unmanned master stream devices or monitor nozzles; if this is impossible, withdraw from area and let fire burn.

SPILL OR LEAK

- ELIMINATE all ignition sources (no smoking, flares, sparks or flames) from immediate area.
- All equipment used when handling the product must be grounded.
- Do not touch or walk through spilled material.
- Stop leak if you can do it without risk.
- Prevent entry into waterways, sewers, basements or confined areas.
- A vapor-suppressing foam may be used to reduce vapors.
- Absorb or cover with dry earth, sand or other non-combustible material and transfer to containers.
- Use clean, non-sparking tools to collect absorbed material.

Large Spill

- Dike far ahead of liquid spill for later disposal.
- Water spray may reduce vapor, but may not prevent ignition in closed spaces.

FIRST AID

Refer to the “General First Aid” section.

Specific First Aid:

- Wash skin with soap and water.
- In case of burns, immediately cool affected skin for as long as possible with cold water. Do not remove clothing if adhering to skin.

GUIDE FLAMMABLE LIQUIDS - TOXIC

131

POTENTIAL HAZARDS

HEALTH

- **TOXIC; may be fatal if inhaled, ingested or absorbed through skin.**
- Inhalation or contact with some of these materials will irritate or burn skin and eyes.
- Methyl chloroacetate (UN2295) is an eye irritant/lachrymator (causes flow of tears).
- Fire will produce irritating, corrosive and/or toxic gases.
- Vapors may cause dizziness or asphyxiation, especially when in closed or confined areas.
- Runoff from fire control or dilution water may cause environmental contamination.

FIRE OR EXPLOSION

- **HIGHLY FLAMMABLE: Will be easily ignited by heat, sparks or flames.**
- **CAUTION: Methanol (UN1230) will burn with an invisible flame. Use an alternate method of detection (thermal camera, broom handle, etc.)**
- Vapors may form explosive mixtures with air.
- Vapors may travel to source of ignition and flash back.
- Most vapors are heavier than air. They will spread along the ground and collect in low or confined areas (sewers, basements, tanks, etc.).
- Vapor explosion and poison hazard indoors, outdoors or in sewers.
- Those substances designated with a **(P)** may polymerize explosively when heated or involved in a fire.
- Runoff to sewer may create fire or explosion hazard.
- Containers may explode when heated.
- Many liquids will float on water.

PUBLIC SAFETY

- **CALL 911. Then call emergency response telephone number on shipping paper.** If shipping paper not available or no answer, refer to appropriate telephone number listed on the inside back cover.
- Keep unauthorized personnel away.
- Stay upwind, uphill and/or upstream.
- Ventilate closed spaces before entering, but only if properly trained and equipped.

PROTECTIVE CLOTHING

- Wear positive pressure self-contained breathing apparatus (SCBA).
- Wear chemical protective clothing that is specifically recommended by the manufacturer **when there is NO RISK OF FIRE.**
- Structural firefighters' protective clothing provides thermal protection **but only limited chemical protection.**

EVACUATION

Immediate precautionary measure

- Isolate spill or leak area for at least 50 meters (150 feet) in all directions.

Spill

- For **highlighted materials**: see Table 1 - Initial Isolation and Protective Action Distances.
- For non-highlighted materials: increase the immediate precautionary measure distance, in the downwind direction, as necessary.

Fire

- If tank, rail tank car or highway tank is involved in a fire, ISOLATE for 800 meters (1/2 mile) in all directions; also, consider initial evacuation for 800 meters (1/2 mile) in all directions.

EMERGENCY RESPONSE

FIRE

CAUTION: The majority of these products have a very low flash point. Use of water spray when fighting fire may be inefficient.

CAUTION: Methanol (UN1230) will burn with an invisible flame. Use an alternate method of detection (thermal camera, broom handle, etc.)

Small Fire

- Dry chemical, CO₂, water spray or alcohol-resistant foam.

Large Fire

- Water spray, fog or alcohol-resistant foam.
- If it can be done safely, move undamaged containers away from the area around the fire.
- Dike runoff from fire control for later disposal.
- Avoid aiming straight or solid streams directly onto the product.

Fire Involving Tanks, Rail Tank Cars or Highway Tanks

- Fight fire from maximum distance or use unmanned master stream devices or monitor nozzles.
- Cool containers with flooding quantities of water until well after fire is out.
- Withdraw immediately in case of rising sound from venting safety devices or discoloration of tank.
- ALWAYS stay away from tanks in direct contact with flames.
- For massive fire, use unmanned master stream devices or monitor nozzles; if this is impossible, withdraw from area and let fire burn.

SPILL OR LEAK

- ELIMINATE all ignition sources (no smoking, flares, sparks or flames) from immediate area.
- All equipment used when handling the product must be grounded.
- Do not touch or walk through spilled material.
- Stop leak if you can do it without risk.
- Prevent entry into waterways, sewers, basements or confined areas.
- A vapor-suppressing foam may be used to reduce vapors.

Small Spill

- Absorb with earth, sand or other non-combustible material and transfer to containers for later disposal.
- Use clean, non-sparking tools to collect absorbed material.

Large Spill

- Dike far ahead of liquid spill for later disposal.
- Water spray may reduce vapor, but may not prevent ignition in closed spaces.

FIRST AID

Refer to the "General First Aid" section.

Specific First Aid:

- Wash skin with soap and water.
- In case of burns, immediately cool affected skin for as long as possible with cold water. Do not remove clothing if adhering to skin.



In Canada, an Emergency Response Assistance Plan (ERAP) may be required for this product. Please consult the shipping paper and/or the "ERAP" section.

GUIDE FLAMMABLE LIQUIDS - CORROSIVE

132

POTENTIAL HAZARDS

FIRE OR EXPLOSION

- Flammable/combustible material.
- May be ignited by heat, sparks or flames.
- Vapors may form explosive mixtures with air.
- Vapors may travel to source of ignition and flash back.
- Most vapors are heavier than air. They will spread along the ground and collect in low or confined areas (sewers, basements, tanks, etc.).
- Vapor explosion hazard indoors, outdoors or in sewers.
- Those substances designated with a (P) may polymerize explosively when heated or involved in a fire.
- Runoff to sewer may create fire or explosion hazard.
- Containers may explode when heated.
- Many liquids will float on water.

HEALTH

- May cause toxic effects if inhaled or ingested.
- Contact with substance may cause severe burns to skin and eyes.
- Fire will produce irritating, corrosive and/or toxic gases.
- Vapors may cause dizziness or asphyxiation, especially when in closed or confined areas.
- Runoff from fire control or dilution water may cause environmental contamination.

PUBLIC SAFETY

- **CALL 911. Then call emergency response telephone number on shipping paper.** If shipping paper not available or no answer, refer to appropriate telephone number listed on the inside back cover.
- Keep unauthorized personnel away.
- Stay upwind, uphill and/or upstream.
- Ventilate closed spaces before entering, but only if properly trained and equipped.

PROTECTIVE CLOTHING

- Wear positive pressure self-contained breathing apparatus (SCBA).
- Wear chemical protective clothing that is specifically recommended by the manufacturer **when there is NO RISK OF FIRE.**
- Structural firefighters' protective clothing provides thermal protection **but only limited chemical protection.**

EVACUATION

Immediate precautionary measure

- Isolate spill or leak area for at least 50 meters (150 feet) in all directions.

Spill

- For **highlighted materials**: see Table 1 - Initial Isolation and Protective Action Distances.
- For non-highlighted materials: increase the immediate precautionary measure distance, in the downwind direction, as necessary.

Fire

- If tank, rail tank car or highway tank is involved in a fire, ISOLATE for 800 meters (1/2 mile) in all directions; also, consider initial evacuation for 800 meters (1/2 mile) in all directions.

EMERGENCY RESPONSE

FIRE

- Some of these materials may react violently with water.

Small Fire

- Dry chemical, CO₂, water spray or alcohol-resistant foam.

Large Fire

- Water spray, fog or alcohol-resistant foam.
- If it can be done safely, move undamaged containers away from the area around the fire.
- Dike runoff from fire control for later disposal.
- Do not get water inside containers.

Fire Involving Tanks, Rail Tank Cars or Highway Tanks

- Fight fire from maximum distance or use unmanned master stream devices or monitor nozzles.
- Cool containers with flooding quantities of water until well after fire is out.
- Withdraw immediately in case of rising sound from venting safety devices or discoloration of tank.
- ALWAYS stay away from tanks in direct contact with flames.
- For massive fire, use unmanned master stream devices or monitor nozzles; if this is impossible, withdraw from area and let fire burn.

SPILL OR LEAK

- ELIMINATE all ignition sources (no smoking, flares, sparks or flames) from immediate area.
- All equipment used when handling the product must be grounded.
- Do not touch or walk through spilled material.
- Stop leak if you can do it without risk.
- Prevent entry into waterways, sewers, basements or confined areas.
- A vapor-suppressing foam may be used to reduce vapors.
- Absorb with earth, sand or other non-combustible material.
- For **hydrazine**, absorb with DRY sand or inert absorbent (vermiculite or absorbent pads).
- Use clean, non-sparking tools to collect absorbed material.

Large Spill

- Dike far ahead of liquid spill for later disposal.
- Water spray may reduce vapor, but may not prevent ignition in closed spaces.

FIRST AID

Refer to the "General First Aid" section.

Specific First Aid:

- For corrosives, in case of contact, immediately flush skin or eyes with running water for at least 30 minutes. Additional flushing may be required.
- In case of burns, immediately cool affected skin for as long as possible with cold water. Do not remove clothing if adhering to skin.



In Canada, an Emergency Response Assistance Plan (ERAP) may be required for this product. Please consult the shipping paper and/or the "ERAP" section.

GUIDE **FLAMMABLE SOLIDS**

133

POTENTIAL HAZARDS

FIRE OR EXPLOSION

- Flammable/combustible material.
- May be ignited by friction, heat, sparks or flames.
- Some may burn rapidly with flare-burning effect.
- Powders, dusts, shavings, borings, turnings or cuttings may explode or burn with explosive violence.
- Substance may be transported in a molten form at a temperature that may be above its flash point.
- May re-ignite after fire is extinguished.

HEALTH

- Fire may produce irritating and/or toxic gases.
- Contact may cause burns to skin and eyes.
- Contact with molten substance may cause severe burns to skin and eyes.
- Runoff from fire control or dilution water may cause environmental contamination.

PUBLIC SAFETY

- **CALL 911. Then call emergency response telephone number on shipping paper.** If shipping paper not available or no answer, refer to appropriate telephone number listed on the inside back cover.
- Keep unauthorized personnel away.
- Stay upwind, uphill and/or upstream.

PROTECTIVE CLOTHING

- Wear positive pressure self-contained breathing apparatus (SCBA).
- Structural firefighters' protective clothing provides thermal protection **but only limited chemical protection.**

EVACUATION

Immediate precautionary measure

- Isolate spill or leak area for at least 25 meters (75 feet) in all directions.

Large Spill

- Consider initial downwind evacuation for at least 100 meters (330 feet).

Fire

- If tank, rail tank car or highway tank is involved in a fire, ISOLATE for 800 meters (1/2 mile) in all directions; also, consider initial evacuation for 800 meters (1/2 mile) in all directions.

EMERGENCY RESPONSE**FIRE****Small Fire**

- Dry chemical, CO₂, sand, earth, water spray or regular foam.

Large Fire

- Water spray, fog or regular foam.
- If it can be done safely, move undamaged containers away from the area around the fire.

Fire Involving Metal Pigments or Pastes (e.g. "Aluminum Paste")

- Aluminum Paste fires should be treated as a combustible metal fire. Use DRY sand, graphite powder, dry sodium chloride-based extinguishers or class D extinguishers. Also, see GUIDE 170.

Fire Involving Tanks, Rail Tank Cars or Highway Tanks

- Cool containers with flooding quantities of water until well after fire is out.
- For massive fire, use unmanned master stream devices or monitor nozzles; if this is impossible, withdraw from area and let fire burn.
- Withdraw immediately in case of rising sound from venting safety devices or discoloration of tank.
- ALWAYS stay away from tanks in direct contact with flames.

SPILL OR LEAK

- ELIMINATE all ignition sources (no smoking, flares, sparks or flames) from immediate area.
- Do not touch or walk through spilled material.

Small Dry Spill

- With clean shovel, place material into clean, dry container and cover loosely; move containers from spill area.

Large Spill

- Wet down with water and dike for later disposal.
- Prevent entry into waterways, sewers, basements or confined areas.

FIRST AID

Refer to the "General First Aid" section.

Specific First Aid:

- Removal of solidified molten material from skin requires medical assistance.



In Canada, an Emergency Response Assistance Plan (ERAP) may be required for this product. Please consult the shipping paper and/or the "ERAP" section.

GUIDE 134

FLAMMABLE SOLIDS - TOXIC AND/OR CORROSIVE

POTENTIAL HAZARDS

FIRE OR EXPLOSION

- Flammable/combustible material.
- May be ignited by heat, sparks or flames.
- When heated, vapors may form explosive mixtures with air: indoors, outdoors and sewers explosion hazards.
- Corrosives in contact with metals may evolve flammable hydrogen gas.
- Containers may explode when heated.

HEALTH

- **TOXIC and/or CORROSIVE**; inhalation, ingestion or skin contact with material may cause severe injury or death.
- Fire will produce irritating, corrosive and/or toxic gases.
- Runoff from fire control or dilution water may be corrosive and/or toxic and cause environmental contamination.

PUBLIC SAFETY

- **CALL 911. Then call emergency response telephone number on shipping paper.** If shipping paper not available or no answer, refer to appropriate telephone number listed on the inside back cover.
- Stay upwind, uphill and/or upstream.
- Keep unauthorized personnel away.
- Ventilate closed spaces before entering, but only if properly trained and equipped.

PROTECTIVE CLOTHING

- Wear positive pressure self-contained breathing apparatus (SCBA).
- Wear chemical protective clothing that is specifically recommended by the manufacturer **when there is NO RISK OF FIRE.**
- Structural firefighters' protective clothing provides thermal protection **but only limited chemical protection.**

EVACUATION

Immediate precautionary measure

- Isolate spill or leak area for at least 25 meters (75 feet) in all directions.

Large Spill

- Consider initial downwind evacuation for at least 100 meters (330 feet).

Fire

- If tank, rail tank car or highway tank is involved in a fire, ISOLATE for 800 meters (1/2 mile) in all directions; also, consider initial evacuation for 800 meters (1/2 mile) in all directions.

EMERGENCY RESPONSE

FIRE**Small Fire**

- Dry chemical, CO₂, water spray or alcohol-resistant foam.

Large Fire

- Water spray, fog or alcohol-resistant foam.
- If it can be done safely, move undamaged containers away from the area around the fire.
- Avoid aiming straight or solid streams directly onto the product.
- Do not get water inside containers.
- Dike runoff from fire control for later disposal.

Fire Involving Tanks, Rail Tank Cars or Highway Tanks

- Fight fire from maximum distance or use unmanned master stream devices or monitor nozzles.
- Cool containers with flooding quantities of water until well after fire is out.
- Withdraw immediately in case of rising sound from venting safety devices or discoloration of tank.
- ALWAYS stay away from tanks in direct contact with flames.

SPILL OR LEAK

- ELIMINATE all ignition sources (no smoking, flares, sparks or flames) from immediate area.
- Stop leak if you can do it without risk.
- Do not touch damaged containers or spilled material unless wearing appropriate protective clothing.
- Prevent entry into waterways, sewers, basements or confined areas.
- Use clean, non-sparking tools to collect material and place it into loosely covered plastic containers for later disposal.

FIRST AID

Refer to the "General First Aid" section.

Specific First Aid:

- For corrosives, in case of contact, immediately flush skin or eyes with running water for at least 30 minutes. Additional flushing may be required.



In Canada, an Emergency Response Assistance Plan (ERAP) may be required for this product. Please consult the shipping paper and/or the "ERAP" section.

GUIDE SUBSTANCES - SPONTANEOUSLY COMBUSTIBLE

135

POTENTIAL HAZARDS

FIRE OR EXPLOSION

- Flammable/combustible material.
- May ignite on contact with moist air or moisture.
- May burn rapidly with flare-burning effect.
- Some react vigorously or explosively on contact with water.
- Some may decompose explosively when heated or involved in a fire.
- May re-ignite after fire is extinguished.
- Runoff may create fire or explosion hazard.
- Containers may explode when heated.

HEALTH

- Fire will produce irritating, corrosive and/or toxic gases.
- Inhalation of decomposition products may cause severe injury or death.
- Contact with substance may cause severe burns to skin and eyes.
- Runoff from fire control or dilution water may cause environmental contamination.

CAUTION: Pentaborane (UN1380) is highly toxic and may be fatal if inhaled, ingested or absorbed through skin.

PUBLIC SAFETY

- **CALL 911. Then call emergency response telephone number on shipping paper.** If shipping paper not available or no answer, refer to appropriate telephone number listed on the inside back cover.
- Stay upwind, uphill and/or upstream.
- Keep unauthorized personnel away.

PROTECTIVE CLOTHING

- Wear positive pressure self-contained breathing apparatus (SCBA).
- Wear chemical protective clothing that is specifically recommended by the manufacturer **when there is NO RISK OF FIRE.**
- Structural firefighters' protective clothing provides thermal protection **but only limited chemical protection.**

EVACUATION

Immediate precautionary measure

- Isolate spill or leak area in all directions for at least 50 meters (150 feet) for liquids and at least 25 meters (75 feet) for solids.

Spill

- For **highlighted materials**: see Table 1 - Initial Isolation and Protective Action Distances.
- For non-highlighted materials: increase the immediate precautionary measure distance, in the downwind direction, as necessary.

Fire

- If tank, rail tank car or highway tank is involved in a fire, ISOLATE for 800 meters (1/2 mile) in all directions; also, consider initial evacuation for 800 meters (1/2 mile) in all directions.

EMERGENCY RESPONSE

FIRE

- **DO NOT USE WATER, CO₂ OR FOAM ON MATERIAL ITSELF.**
- Some of these materials may react violently with water.

CAUTION: For Xanthates, UN3342 and for Dithionite (Hydrosulfite/Hydrosulphite) UN1384, UN1923 and UN1929, USE FLOODING AMOUNTS OF WATER for SMALL AND LARGE fires to stop the reaction. Smothering will not work for these materials, they do not need air to burn.

Small Fire

- Dry chemical, soda ash, lime or DRY sand, **EXCEPT for UN1384, UN1923, UN1929 and UN3342.**

Large Fire

- DRY sand, dry chemical, soda ash or lime **EXCEPT for UN1384, UN1923, UN1929 and UN3342**, or withdraw from area and let fire burn.

CAUTION: UN3342 when flooded with water will continue to evolve flammable Carbon disulfide/Carbon disulphide vapors.

- If it can be done safely, move undamaged containers away from the area around the fire.

Fire Involving Tanks, Rail Tank Cars or Highway Tanks

- Fight fire from maximum distance or use unmanned master stream devices or monitor nozzles.
- Do not get water inside containers or in contact with substance.
- Cool containers with flooding quantities of water until well after fire is out.
- Withdraw immediately in case of rising sound from venting safety devices or discoloration of tank.
- **ALWAYS** stay away from tanks in direct contact with flames.

SPILL OR LEAK

- **ELIMINATE** all ignition sources (no smoking, flares, sparks or flames) from immediate area.
- Do not touch or walk through spilled material.
- Stop leak if you can do it without risk.

Small Spill

CAUTION: For spills of Xanthates, UN3342 and for Dithionite (Hydrosulfite/Hydrosulphite), UN1384, UN1923 and UN1929, dissolve in 5 parts water and collect for proper disposal.

CAUTION: UN3342 when flooded with water will continue to evolve flammable Carbon disulfide/Carbon disulphide vapors.

- Cover with DRY earth, DRY sand or other non-combustible material followed with plastic sheet to minimize spreading or contact with rain.
- Use clean, non-sparking tools to collect material and place it into loosely covered plastic containers for later disposal.
- Prevent entry into waterways, sewers, basements or confined areas.

FIRST AID

Refer to the "General First Aid" section.



In Canada, an Emergency Response Assistance Plan (ERAP) may be required for this product. Please consult the shipping paper and/or the "ERAP" section.

POTENTIAL HAZARDS

FIRE OR EXPLOSION

- Extremely flammable; will ignite itself if exposed to air.
- Burns rapidly, releasing dense, white, irritating fumes.
- Substance may be transported in a molten form.
- May re-ignite after fire is extinguished.
- Corrosives in contact with metals may evolve flammable hydrogen gas.
- Containers may explode when heated.

HEALTH

- Fire will produce irritating, corrosive and/or toxic gases.
- **TOXIC and/or CORROSIVE**; ingestion of substance or inhalation of decomposition products will cause severe injury or death.
- Contact with substance may cause severe burns to skin and eyes.
- Some effects may be experienced due to skin absorption.
- Runoff from fire control or dilution water may be corrosive and/or toxic and cause environmental contamination.

PUBLIC SAFETY

- **CALL 911. Then call emergency response telephone number on shipping paper.** If shipping paper not available or no answer, refer to appropriate telephone number listed on the inside back cover.
- Stay upwind, uphill and/or upstream.
- Keep unauthorized personnel away.

PROTECTIVE CLOTHING

- Wear positive pressure self-contained breathing apparatus (SCBA).
- Wear chemical protective clothing that is specifically recommended by the manufacturer **when there is NO RISK OF FIRE**.
- Structural firefighters' protective clothing provides thermal protection **but only limited chemical protection**.
- **For Phosphorus (UN1381): Special aluminized protective clothing should be worn when direct contact with the substance is possible.**

EVACUATION

Immediate precautionary measure

- Isolate spill or leak area in all directions for at least 50 meters (150 feet) for liquids and at least 25 meters (75 feet) for solids.

Spill

- For **highlighted materials**: see Table 1 - Initial Isolation and Protective Action Distances.
- For non-highlighted materials: increase the immediate precautionary measure distance, in the downwind direction, as necessary.

Fire

- If tank, rail tank car or highway tank is involved in a fire, ISOLATE for 800 meters (1/2 mile) in all directions; also, consider initial evacuation for 800 meters (1/2 mile) in all directions.

EMERGENCY RESPONSE

FIRE

Small Fire

- Water spray, wet sand or wet earth.

Large Fire

- Water spray or fog.
- **Do not scatter spilled material with high-pressure water streams.**
- If it can be done safely, move undamaged containers away from the area around the fire.

Fire Involving Tanks, Rail Tank Cars or Highway Tanks

- Fight fire from maximum distance or use unmanned master stream devices or monitor nozzles.
- Cool containers with flooding quantities of water until well after fire is out.
- Withdraw immediately in case of rising sound from venting safety devices or discoloration of tank.
- ALWAYS stay away from tanks in direct contact with flames.

SPILL OR LEAK

- ELIMINATE all ignition sources (no smoking, flares, sparks or flames) from immediate area.
- Do not touch or walk through spilled material.
- Do not touch damaged containers or spilled material unless wearing appropriate protective clothing.
- Stop leak if you can do it without risk.

Small Spill

- Cover with water, sand or earth. Shovel into metal container and keep material under water.

Large Spill

- Dike for later disposal and cover with wet sand or earth.
- Prevent entry into waterways, sewers, basements or confined areas.

FIRST AID

Refer to the "General First Aid" section.

Specific First Aid:

- In case of contact with substance, keep exposed skin areas immersed in water or covered with wet bandages until medical attention is received.
- Removal of solidified molten material from skin requires medical assistance.
- Remove and isolate contaminated clothing and shoes at the site and place in metal container filled with water. Fire hazard if allowed to dry.



In Canada, an Emergency Response Assistance Plan (ERAP) may be required for this product. Please consult the shipping paper and/or the "ERAP" section.

GUIDE SUBSTANCES - WATER-REACTIVE - CORROSIVE

137

POTENTIAL HAZARDS

HEALTH

- **CORROSIVE and/or TOXIC**; inhalation, ingestion or contact (skin, eyes) with vapors, dusts or substance may cause severe injury, burns or death.
- Fire will produce irritating, corrosive and/or toxic gases.
- Reaction with water may generate much heat that will increase the concentration of fumes in the air.
- Contact with molten substance may cause severe burns to skin and eyes.
- Runoff from fire control or dilution water may cause environmental contamination.

FIRE OR EXPLOSION

- **EXCEPT FOR ACETIC ANHYDRIDE (UN1715), THAT IS FLAMMABLE**, some of these materials may burn, but none ignite readily.
- May ignite combustibles (wood, paper, oil, clothing, etc.).
- Substance will react with water (some violently), releasing corrosive and/or toxic gases and runoff.
- Flammable/toxic gases may accumulate in confined areas (basement, tanks, hopper/tank cars, etc.).
- Contact with metals may evolve flammable hydrogen gas.
- Containers may explode when heated or if contaminated with water.
- Substance may be transported in a molten form.

PUBLIC SAFETY

- **CALL 911. Then call emergency response telephone number on shipping paper.** If shipping paper not available or no answer, refer to appropriate telephone number listed on the inside back cover.
- Keep unauthorized personnel away.
- Stay upwind, uphill and/or upstream.
- Ventilate closed spaces before entering, but only if properly trained and equipped.

PROTECTIVE CLOTHING

- Wear positive pressure self-contained breathing apparatus (SCBA).
- Wear chemical protective clothing that is specifically recommended by the manufacturer **when there is NO RISK OF FIRE**.
- Structural firefighters' protective clothing provides thermal protection **but only limited chemical protection**.

EVACUATION

Immediate precautionary measure

- Isolate spill or leak area in all directions for at least 50 meters (150 feet) for liquids and at least 25 meters (75 feet) for solids.

Spill

- For **highlighted materials**: see Table 1 - Initial Isolation and Protective Action Distances.
- For non-highlighted materials: increase the immediate precautionary measure distance, in the downwind direction, as necessary.

Fire

- If tank, rail tank car or highway tank is involved in a fire, ISOLATE for 800 meters (1/2 mile) in all directions; also, consider initial evacuation for 800 meters (1/2 mile) in all directions.

EMERGENCY RESPONSE

FIRE

- When material is not involved in fire, do not use water on material itself.

Small Fire

- Dry chemical or CO₂.
- If it can be done safely, move undamaged containers away from the area around the fire.

Large Fire

- Flood fire area with large quantities of water, while knocking down vapors with water fog. If insufficient water supply, responders should withdraw.

Fire Involving Tanks, Rail Tank Cars or Highway Tanks

- Cool containers with flooding quantities of water until well after fire is out.
- Do not get water inside containers.
- Withdraw immediately in case of rising sound from venting safety devices or discoloration of tank.
- ALWAYS stay away from tanks in direct contact with flames.

SPILL OR LEAK

- Do not touch damaged containers or spilled material unless wearing appropriate protective clothing.
- Stop leak if you can do it without risk.
- Use water spray to reduce vapors; do not put water directly on leak, spill area or inside container.
- Keep combustibles (wood, paper, oil, etc.) away from spilled material.

Small Spill

- Cover with DRY earth, DRY sand or other non-combustible material followed with plastic sheet to minimize spreading or contact with rain.
- Use clean, non-sparking tools to collect material and place it into loosely covered plastic containers for later disposal.
- Prevent entry into waterways, sewers, basements or confined areas.

FIRST AID

Refer to the "General First Aid" section.

Specific First Aid:

- For corrosives, in case of contact, immediately flush skin or eyes with running water for at least 30 minutes. Additional flushing may be required.
- Removal of solidified molten material from skin requires medical assistance.



In Canada, an Emergency Response Assistance Plan (ERAP) may be required for this product. Please consult the shipping paper and/or the "ERAP" section.

GUIDE 138 SUBSTANCES - WATER-REACTIVE (EMITTING FLAMMABLE GASES)

POTENTIAL HAZARDS

FIRE OR EXPLOSION

- Produce flammable gases on contact with water.
- May ignite on contact with water or moist air.
- Some react vigorously or explosively on contact with water.
- May be ignited by heat, sparks or flames.
- May re-ignite after fire is extinguished.
- Some are transported in highly flammable liquids.
- Runoff may create fire or explosion hazard.

HEALTH

- Inhalation or contact with vapors, substance or decomposition products may cause severe injury or death.
- May produce corrosive solutions on contact with water.
- Fire will produce irritating, corrosive and/or toxic gases.
- Runoff from fire control or dilution water may cause environmental contamination.

PUBLIC SAFETY

- **CALL 911. Then call emergency response telephone number on shipping paper.** If shipping paper not available or no answer, refer to appropriate telephone number listed on the inside back cover.
- Keep unauthorized personnel away.
- Stay upwind, uphill and/or upstream.
- Ventilate closed spaces before entering, but only if properly trained and equipped.

PROTECTIVE CLOTHING

- Wear positive pressure self-contained breathing apparatus (SCBA).
- Wear chemical protective clothing that is specifically recommended by the manufacturer **when there is NO RISK OF FIRE.**
- Structural firefighters' protective clothing provides thermal protection **but only limited chemical protection.**

EVACUATION

Immediate precautionary measure

- Isolate spill or leak area in all directions for at least 50 meters (150 feet) for liquids and at least 25 meters (75 feet) for solids.

Large Spill

- Consider initial downwind evacuation for at least 300 meters (1000 feet).

Fire

- If tank, rail tank car or highway tank is involved in a fire, ISOLATE for 800 meters (1/2 mile) in all directions; also, consider initial evacuation for 800 meters (1/2 mile) in all directions.

EMERGENCY RESPONSE

FIRE

- **DO NOT USE WATER OR FOAM.**

Small Fire

- Dry chemical, soda ash, lime or sand.

Large Fire

- DRY sand, dry chemical, soda ash or lime or withdraw from area and let fire burn.
- If it can be done safely, move undamaged containers away from the area around the fire.

Fire Involving Metals or Powders (Aluminum, Lithium, Magnesium, etc.)

- Use dry chemical, DRY sand, sodium chloride powder, graphite powder or class D extinguishers; in addition, for Lithium you may use Lith-X® powder or copper powder. Also, see GUIDE 170.

Fire Involving Tanks, Rail Tank Cars or Highway Tanks

- Fight fire from maximum distance or use unmanned master stream devices or monitor nozzles.
- Do not get water inside containers.
- Cool containers with flooding quantities of water until well after fire is out.
- Withdraw immediately in case of rising sound from venting safety devices or discoloration of tank.
- ALWAYS stay away from tanks in direct contact with flames.

SPILL OR LEAK

- ELIMINATE all ignition sources (no smoking, flares, sparks or flames) from immediate area.
- Do not touch or walk through spilled material.
- Stop leak if you can do it without risk.
- Use water spray to reduce vapors or divert vapor cloud drift. Avoid allowing water runoff to contact spilled material.
- **DO NOT GET WATER on spilled substance or inside containers.**

Small Spill

- Cover with DRY earth, DRY sand or other non-combustible material followed with plastic sheet to minimize spreading or contact with rain.
- Dike for later disposal; do not apply water unless directed to do so.

Powder Spill

- Cover powder spill with plastic sheet or tarp to minimize spreading and keep powder dry.
- **DO NOT CLEAN-UP OR DISPOSE OF, EXCEPT UNDER SUPERVISION OF A SPECIALIST.**

FIRST AID

Refer to the "General First Aid" section.

Specific First Aid:

- In case of contact with substance, wipe from skin immediately; flush skin or eyes with running water for at least 20 minutes.



In Canada, an Emergency Response Assistance Plan (ERAP) may be required for this product. Please consult the shipping paper and/or the "ERAP" section.

GUIDE 139 SUBSTANCES - WATER-REACTIVE (EMITTING FLAMMABLE AND TOXIC GASES)

POTENTIAL HAZARDS

FIRE OR EXPLOSION

- Produce flammable and toxic gases on contact with water.
- May ignite on contact with water or moist air.
- Some react vigorously or explosively on contact with water.
- May be ignited by heat, sparks or flames.
- May re-ignite after fire is extinguished.
- Some are transported in highly flammable liquids.
- Containers may explode when heated.
- Runoff may create fire or explosion hazard.

HEALTH

- Highly toxic: contact with water produces toxic gas, may be fatal if inhaled.
- Inhalation or contact with vapors, substance or decomposition products may cause severe injury or death.
- May produce corrosive solutions on contact with water.
- Fire will produce irritating, corrosive and/or toxic gases.
- Runoff from fire control or dilution water may cause environmental contamination.

PUBLIC SAFETY

- **CALL 911. Then call emergency response telephone number on shipping paper.** If shipping paper not available or no answer, refer to appropriate telephone number listed on the inside back cover.
- Keep unauthorized personnel away.
- Stay upwind, uphill and/or upstream.
- Ventilate closed spaces before entering, but only if properly trained and equipped.

PROTECTIVE CLOTHING

- Wear positive pressure self-contained breathing apparatus (SCBA).
- Wear chemical protective clothing that is specifically recommended by the manufacturer **when there is NO RISK OF FIRE.**
- Structural firefighters' protective clothing provides thermal protection **but only limited chemical protection.**

EVACUATION

Immediate precautionary measure

- Isolate spill or leak area in all directions for at least 50 meters (150 feet) for liquids and at least 25 meters (75 feet) for solids.

Spill

- For **highlighted materials**: see Table 1 - Initial Isolation and Protective Action Distances.
- For non-highlighted materials: increase the immediate precautionary measure distance, in the downwind direction, as necessary.

Fire

- If tank, rail tank car or highway tank is involved in a fire, ISOLATE for 800 meters (1/2 mile) in all directions; also, consider initial evacuation for 800 meters (1/2 mile) in all directions.

EMERGENCY RESPONSE

FIRE

- **DO NOT USE WATER OR FOAM. (FOAM MAY BE USED FOR CHLOROSILANES, SEE BELOW)**

Small Fire

- Dry chemical, soda ash, lime or sand.

Large Fire

- DRY sand, dry chemical, soda ash or lime or withdraw from area and let fire burn.
- **FOR CHLOROSILANES, DO NOT USE WATER;** use alcohol-resistant foam; **DO NOT USE** dry chemicals, soda ash or lime on chlorosilane fires (large or small) as they may release large quantities of hydrogen gas that may explode.
- If it can be done safely, move undamaged containers away from the area around the fire.

Fire Involving Tanks, Rail Tank Cars or Highway Tanks

- Fight fire from maximum distance or use unmanned master stream devices or monitor nozzles.
- Cool containers with flooding quantities of water until well after fire is out.
- Do not get water inside containers.
- Withdraw immediately in case of rising sound from venting safety devices or discoloration of tank.
- **ALWAYS** stay away from tanks in direct contact with flames.

SPILL OR LEAK

- **ELIMINATE** all ignition sources (no smoking, flares, sparks or flames) from immediate area.
- Do not touch or walk through spilled material.
- Stop leak if you can do it without risk.
- **DO NOT GET WATER on spilled substance or inside containers.**
- Use water spray to reduce vapors or divert vapor cloud drift. Avoid allowing water runoff to contact spilled material.
- **FOR CHLOROSILANES,** use alcohol-resistant foam to reduce vapors.

Small Spill

- Cover with DRY earth, DRY sand or other non-combustible material followed with plastic sheet to minimize spreading or contact with rain.
- Dike for later disposal; do not apply water unless directed to do so.

Powder Spill

- Cover powder spill with plastic sheet or tarp to minimize spreading and keep powder dry.
- **DO NOT CLEAN-UP OR DISPOSE OF, EXCEPT UNDER SUPERVISION OF A SPECIALIST.**

FIRST AID

Refer to the "General First Aid" section.

Specific First Aid:

- In case of contact with substance, wipe from skin immediately; flush skin or eyes with running water for at least 20 minutes.



In Canada, an Emergency Response Assistance Plan (ERAP) may be required for this product. Please consult the shipping paper and/or the "ERAP" section.

POTENTIAL HAZARDS

FIRE OR EXPLOSION

CAUTION: Ammonium nitrate products may explode if involved in fire or contaminated with hydrocarbons (fuels), organic matter, other contaminants or when hot molten and contained. Treat as an explosive (GUIDE 112).

- These substances will accelerate burning when involved in a fire.
- Some may decompose explosively when heated or involved in a fire.
- May explode from heat or contamination.
- Some will react explosively with hydrocarbons (fuels).
- May ignite combustibles (wood, paper, oil, clothing, etc.).
- Containers may explode when heated.
- Runoff may create fire or explosion hazard.

HEALTH

- Inhalation, ingestion or contact (skin, eyes) with vapors or substance may cause severe injury, burns or death.
- Fire may produce irritating, corrosive and/or toxic gases.
- Runoff from fire control or dilution water may cause environmental contamination.

PUBLIC SAFETY

- **CALL 911. Then call emergency response telephone number on shipping paper.** If shipping paper not available or no answer, refer to appropriate telephone number listed on the inside back cover.
- Keep unauthorized personnel away.
- Stay upwind, uphill and/or upstream.
- Ventilate closed spaces before entering, but only if properly trained and equipped.

PROTECTIVE CLOTHING

- Wear positive pressure self-contained breathing apparatus (SCBA).
- Wear chemical protective clothing that is specifically recommended by the manufacturer **when there is NO RISK OF FIRE.**
- Structural firefighters' protective clothing provides thermal protection **but only limited chemical protection.**

EVACUATION

Immediate precautionary measure

- Isolate spill or leak area in all directions for at least 50 meters (150 feet) for liquids and at least 25 meters (75 feet) for solids.

Large Spill

- Consider initial downwind evacuation for at least 100 meters (330 feet).

Fire

- If tank, rail tank car or highway tank is involved in a fire, ISOLATE for 800 meters (1/2 mile) in all directions; also, consider initial evacuation for 800 meters (1/2 mile) in all directions.
- If **ammonium nitrate products** are in a tank, rail car or truck and involved in a fire, ISOLATE for 1600 meters (1 mile) in all directions; also, initiate evacuation including emergency responders for 1600 meters (1 mile) in all directions.

EMERGENCY RESPONSE**FIRE****Small Fire**

- Use water. Do not use dry chemicals or foams. CO₂ or Halon® may provide limited control.

Large Fire

- Flood fire area with water from a distance.
- Do not move cargo or vehicle if cargo has been exposed to heat.
- If it can be done safely, move undamaged containers away from the area around the fire.

Fire Involving Tanks, Rail Tank Cars or Highway Tanks

- For **ammonium nitrate products**: Do not fight cargo fire. Withdraw, evacuate and isolate area for at least 1600 meters (1 mile). Treat as an explosive (GUIDE 112). Do not enter area for 24 hours or until expert advice has been provided.
- Fight fire from maximum distance or use unmanned master stream devices or monitor nozzles.
- Cool containers with flooding quantities of water until well after fire is out.
- ALWAYS stay away from tanks in direct contact with flames.
- For massive fire, use unmanned master stream devices or monitor nozzles; if this is impossible, withdraw from area and let fire burn.

SPILL OR LEAK

- Keep combustibles (wood, paper, oil, etc.) away from spilled material.
- Do not touch damaged containers or spilled material unless wearing appropriate protective clothing.
- Stop leak if you can do it without risk.
- Do not get water inside containers.

Small Dry Spill

- With clean shovel, place material into clean, dry container and cover loosely; move containers from spill area.

Small Liquid Spill

- Use a non-combustible material like vermiculite or sand to soak up the product and place into a container for later disposal.

Large Spill

- Dike far ahead of liquid spill for later disposal.

FIRST AID

Refer to the "General First Aid" section.

Specific First Aid:

- Contaminated clothing may be a fire risk when dry.



In Canada, an Emergency Response Assistance Plan (ERAP) may be required for this product. Please consult the shipping paper and/or the "ERAP" section.

POTENTIAL HAZARDS

FIRE OR EXPLOSION

- These substances will accelerate burning when involved in a fire.
- May explode from heat or contamination.
- Some may burn rapidly.
- Some will react explosively with hydrocarbons (fuels).
- May ignite combustibles (wood, paper, oil, clothing, etc.).
- Containers may explode when heated.
- Runoff may create fire or explosion hazard.

HEALTH

- Toxic by ingestion.
- Inhalation of dust is toxic.
- Fire may produce irritating, corrosive and/or toxic gases.
- Contact with substance may cause severe burns to skin and eyes.
- Runoff from fire control or dilution water may cause environmental contamination.

PUBLIC SAFETY

- **CALL 911. Then call emergency response telephone number on shipping paper.** If shipping paper not available or no answer, refer to appropriate telephone number listed on the inside back cover.
- Keep unauthorized personnel away.
- Stay upwind, uphill and/or upstream.
- Ventilate closed spaces before entering, but only if properly trained and equipped.

PROTECTIVE CLOTHING

- Wear positive pressure self-contained breathing apparatus (SCBA).
- Wear chemical protective clothing that is specifically recommended by the manufacturer **when there is NO RISK OF FIRE.**
- Structural firefighters' protective clothing provides thermal protection **but only limited chemical protection.**

EVACUATION

Immediate precautionary measure

- Isolate spill or leak area in all directions for at least 50 meters (150 feet) for liquids and at least 25 meters (75 feet) for solids.

Large Spill

- Consider initial downwind evacuation for at least 100 meters (330 feet).

Fire

- If tank, rail tank car or highway tank is involved in a fire, ISOLATE for 800 meters (1/2 mile) in all directions; also, consider initial evacuation for 800 meters (1/2 mile) in all directions.

EMERGENCY RESPONSE**FIRE****Small Fire**

- Use water. Do not use dry chemicals or foams. CO₂ or Halon® may provide limited control.

Large Fire

- Flood fire area with water from a distance.
- Do not move cargo or vehicle if cargo has been exposed to heat.
- If it can be done safely, move undamaged containers away from the area around the fire.

Fire Involving Tanks, Rail Tank Cars or Highway Tanks

- Fight fire from maximum distance or use unmanned master stream devices or monitor nozzles.
- Cool containers with flooding quantities of water until well after fire is out.
- ALWAYS stay away from tanks in direct contact with flames.
- For massive fire, use unmanned master stream devices or monitor nozzles; if this is impossible, withdraw from area and let fire burn.

SPILL OR LEAK

- Keep combustibles (wood, paper, oil, etc.) away from spilled material.
- Do not touch damaged containers or spilled material unless wearing appropriate protective clothing.
- Stop leak if you can do it without risk.

Small Dry Spill

- With clean shovel, place material into clean, dry container and cover loosely; move containers from spill area.

Large Spill

- Dike far ahead of spill for later disposal.

FIRST AID

Refer to the "General First Aid" section.

Specific First Aid:

- Contaminated clothing may be a fire risk when dry.



In Canada, an Emergency Response Assistance Plan (ERAP) may be required for this product. Please consult the shipping paper and/or the "ERAP" section.

GUIDE OXIDIZERS - TOXIC (LIQUID)

142

POTENTIAL HAZARDS

FIRE OR EXPLOSION

- These substances will accelerate burning when involved in a fire.
- May explode from heat or contamination.
- Some will react explosively with hydrocarbons (fuels).
- May ignite combustibles (wood, paper, oil, clothing, etc.).
- Containers may explode when heated.
- Runoff may create fire or explosion hazard.

HEALTH

- **TOXIC**; inhalation, ingestion or contact (skin, eyes) with vapors or substance may cause severe injury, burns or death.
- Fire may produce irritating, corrosive and/or toxic gases.
- Toxic/flammable fumes may accumulate in confined areas (basement, tanks, tank cars, etc.).
- Runoff from fire control or dilution water may cause environmental contamination.

PUBLIC SAFETY

- **CALL 911. Then call emergency response telephone number on shipping paper.** If shipping paper not available or no answer, refer to appropriate telephone number listed on the inside back cover.
- Keep unauthorized personnel away.
- Stay upwind, uphill and/or upstream.
- Ventilate closed spaces before entering, but only if properly trained and equipped.

PROTECTIVE CLOTHING

- Wear positive pressure self-contained breathing apparatus (SCBA).
- Wear chemical protective clothing that is specifically recommended by the manufacturer **when there is NO RISK OF FIRE.**
- Structural firefighters' protective clothing provides thermal protection **but only limited chemical protection.**

EVACUATION

Immediate precautionary measure

- Isolate spill or leak area for at least 50 meters (150 feet) in all directions.

Spill

- For **highlighted materials**: see Table 1 - Initial Isolation and Protective Action Distances.
- For non-highlighted materials: increase the immediate precautionary measure distance, in the downwind direction, as necessary.

Fire

- If tank, rail tank car or highway tank is involved in a fire, ISOLATE for 800 meters (1/2 mile) in all directions; also, consider initial evacuation for 800 meters (1/2 mile) in all directions.

EMERGENCY RESPONSE

FIRE**Small Fire**

- Use water. Do not use dry chemicals or foams. CO₂ or Halon® may provide limited control.

Large Fire

- Flood fire area with water from a distance.
- Do not move cargo or vehicle if cargo has been exposed to heat.
- If it can be done safely, move undamaged containers away from the area around the fire.

Fire Involving Tanks, Rail Tank Cars or Highway Tanks

- Fight fire from maximum distance or use unmanned master stream devices or monitor nozzles.
- Cool containers with flooding quantities of water until well after fire is out.
- ALWAYS stay away from tanks in direct contact with flames.
- For massive fire, use unmanned master stream devices or monitor nozzles; if this is impossible, withdraw from area and let fire burn.

SPILL OR LEAK

- Keep combustibles (wood, paper, oil, etc.) away from spilled material.
- Do not touch damaged containers or spilled material unless wearing appropriate protective clothing.
- Stop leak if you can do it without risk.
- Use water spray to reduce vapors or divert vapor cloud drift.
- Do not get water inside containers.

Small Liquid Spill

- Use a non-combustible material like vermiculite or sand to soak up the product and place into a container for later disposal.

Large Spill

- Dike far ahead of liquid spill for later disposal.

FIRST AID

Refer to the "General First Aid" section.

Specific First Aid:

- Contaminated clothing may be a fire risk when dry.



In Canada, an Emergency Response Assistance Plan (ERAP) may be required for this product. Please consult the shipping paper and/or the "ERAP" section.

POTENTIAL HAZARDS

FIRE OR EXPLOSION

- May explode from friction, heat or contamination.
- These substances will accelerate burning when involved in a fire.
- May ignite combustibles (wood, paper, oil, clothing, etc.).
- Some will react explosively with hydrocarbons (fuels).
- Containers may explode when heated.
- Runoff may create fire or explosion hazard.

HEALTH

- **TOXIC**; inhalation, ingestion or contact (skin, eyes) with vapors, dusts or substance may cause severe injury, burns or death.
- Fire may produce irritating and/or toxic gases.
- Toxic fumes or dust may accumulate in confined areas (basement, tanks, hopper/tank cars, etc.).
- Runoff from fire control or dilution water may cause environmental contamination.

PUBLIC SAFETY

- **CALL 911. Then call emergency response telephone number on shipping paper.** If shipping paper not available or no answer, refer to appropriate telephone number listed on the inside back cover.
- Keep unauthorized personnel away.
- Stay upwind, uphill and/or upstream.
- Ventilate closed spaces before entering, but only if properly trained and equipped.

PROTECTIVE CLOTHING

- Wear positive pressure self-contained breathing apparatus (SCBA).
- Wear chemical protective clothing that is specifically recommended by the manufacturer **when there is NO RISK OF FIRE.**
- Structural firefighters' protective clothing provides thermal protection **but only limited chemical protection.**

EVACUATION

Immediate precautionary measure

- Isolate spill or leak area in all directions for at least 50 meters (150 feet) for liquids and at least 25 meters (75 feet) for solids.

Spill

- For **highlighted materials**: see Table 1 - Initial Isolation and Protective Action Distances.
- For non-highlighted materials: increase the immediate precautionary measure distance, in the downwind direction, as necessary.

Fire

- If tank, rail tank car or highway tank is involved in a fire, ISOLATE for 800 meters (1/2 mile) in all directions; also, consider initial evacuation for 800 meters (1/2 mile) in all directions.

EMERGENCY RESPONSE

FIRE**Small Fire**

- Use water. Do not use dry chemicals or foams. CO₂ or Halon® may provide limited control.

Large Fire

- Flood fire area with water from a distance.
- Do not move cargo or vehicle if cargo has been exposed to heat.
- If it can be done safely, move undamaged containers away from the area around the fire.
- Do not get water inside containers: a violent reaction may occur.

Fire Involving Tanks, Rail Tank Cars or Highway Tanks

- Cool containers with flooding quantities of water until well after fire is out.
- Dike runoff from fire control for later disposal.
- ALWAYS stay away from tanks in direct contact with flames.
- For massive fire, use unmanned master stream devices or monitor nozzles; if this is impossible, withdraw from area and let fire burn.

SPILL OR LEAK

- Keep combustibles (wood, paper, oil, etc.) away from spilled material.
- Do not touch damaged containers or spilled material unless wearing appropriate protective clothing.
- Use water spray to reduce vapors or divert vapor cloud drift.
- Prevent entry into waterways, sewers, basements or confined areas.

Small Spill

- Flush area with large amounts of water.

Large Spill

- **DO NOT CLEAN-UP OR DISPOSE OF, EXCEPT UNDER SUPERVISION OF A SPECIALIST.**

FIRST AID

Refer to the "General First Aid" section.

Specific First Aid:

- Contaminated clothing may be a fire risk when dry.



In Canada, an Emergency Response Assistance Plan (ERAP) may be required for this product. Please consult the shipping paper and/or the "ERAP" section.

GUIDE OXIDIZERS (WATER-REACTIVE)

144

POTENTIAL HAZARDS

FIRE OR EXPLOSION

- May ignite combustibles (wood, paper, oil, clothing, etc.).
- React vigorously and/or explosively with water.
- Produce toxic and/or corrosive substances on contact with water.
- Flammable/toxic gases may accumulate in tanks and hopper cars.
- Some may produce flammable hydrogen gas upon contact with metals.
- Containers may explode when heated.
- Runoff may create fire or explosion hazard.

HEALTH

- **TOXIC**; inhalation or contact with vapor, substance, or decomposition products may cause severe injury or death.
- Fire will produce irritating, corrosive and/or toxic gases.
- Runoff from fire control or dilution water may cause environmental contamination.

PUBLIC SAFETY

- **CALL 911. Then call emergency response telephone number on shipping paper.** If shipping paper not available or no answer, refer to appropriate telephone number listed on the inside back cover.
- Keep unauthorized personnel away.
- Stay upwind, uphill and/or upstream.
- Ventilate closed spaces before entering, but only if properly trained and equipped.

PROTECTIVE CLOTHING

- Wear positive pressure self-contained breathing apparatus (SCBA).
- Wear chemical protective clothing that is specifically recommended by the manufacturer **when there is NO RISK OF FIRE.**
- Structural firefighters' protective clothing provides thermal protection **but only limited chemical protection.**

EVACUATION

Immediate precautionary measure

- Isolate spill or leak area in all directions for at least 50 meters (150 feet) for liquids and at least 25 meters (75 feet) for solids.

Spill

- For **highlighted materials**: see Table 1 - Initial Isolation and Protective Action Distances.
- For non-highlighted materials: increase the immediate precautionary measure distance, in the downwind direction, as necessary.

Fire

- If tank, rail tank car or highway tank is involved in a fire, ISOLATE for 800 meters (1/2 mile) in all directions; also, consider initial evacuation for 800 meters (1/2 mile) in all directions.

EMERGENCY RESPONSE

FIRE

- **DO NOT USE WATER OR FOAM.**

Small Fire

- Dry chemical, soda ash or lime.

Large Fire

- DRY sand, dry chemical, soda ash or lime or withdraw from area and let fire burn.
- Do not move cargo or vehicle if cargo has been exposed to heat.
- If it can be done safely, move undamaged containers away from the area around the fire.

Fire Involving Tanks, Rail Tank Cars or Highway Tanks

- Fight fire from maximum distance or use unmanned master stream devices or monitor nozzles.
- Cool containers with flooding quantities of water until well after fire is out.
- Withdraw immediately in case of rising sound from venting safety devices or discoloration of tank.
- ALWAYS stay away from tanks in direct contact with flames.

SPILL OR LEAK

- ELIMINATE all ignition sources (no smoking, flares, sparks or flames) from immediate area.
- Do not touch damaged containers or spilled material unless wearing appropriate protective clothing.
- Stop leak if you can do it without risk.
- Use water spray to reduce vapors or divert vapor cloud drift. Avoid allowing water runoff to contact spilled material.
- **DO NOT GET WATER on spilled substance or inside containers.**

Small Spill

- Cover with DRY earth, DRY sand or other non-combustible material followed with plastic sheet to minimize spreading or contact with rain.

Large Spill

- **DO NOT CLEAN-UP OR DISPOSE OF, EXCEPT UNDER SUPERVISION OF A SPECIALIST.**

FIRST AID

Refer to the "General First Aid" section.

Specific First Aid:

- Contaminated clothing may be a fire risk when dry.



In Canada, an Emergency Response Assistance Plan (ERAP) may be required for this product. Please consult the shipping paper and/or the "ERAP" section.

GUIDE 145 ORGANIC PEROXIDES (HEAT AND CONTAMINATION SENSITIVE)

POTENTIAL HAZARDS

FIRE OR EXPLOSION

- May explode from heat or contamination.
- May ignite combustibles (wood, paper, oil, clothing, etc.).
- May be ignited by heat, sparks or flames.
- May burn rapidly with flare-burning effect.
- Containers may explode when heated.
- Runoff may create fire or explosion hazard.

HEALTH

- Fire may produce irritating, corrosive and/or toxic gases.
- Ingestion or contact (skin, eyes) with substance may cause severe injury or burns.
- Runoff from fire control or dilution water may cause environmental contamination.

PUBLIC SAFETY

- **CALL 911. Then call emergency response telephone number on shipping paper.** If shipping paper not available or no answer, refer to appropriate telephone number listed on the inside back cover.
- Keep unauthorized personnel away.
- Stay upwind, uphill and/or upstream.

PROTECTIVE CLOTHING

- Wear positive pressure self-contained breathing apparatus (SCBA).
- Wear chemical protective clothing that is specifically recommended by the manufacturer **when there is NO RISK OF FIRE.**
- Structural firefighters' protective clothing provides thermal protection **but only limited chemical protection.**

EVACUATION

Immediate precautionary measure

- Isolate spill or leak area in all directions for at least 50 meters (150 feet) for liquids and at least 25 meters (75 feet) for solids.

Large Spill

- Consider initial evacuation for at least 250 meters (800 feet) in all directions.

Fire

- If tank, rail tank car or highway tank is involved in a fire, ISOLATE for 800 meters (1/2 mile) in all directions; also, consider initial evacuation for 800 meters (1/2 mile) in all directions.

EMERGENCY RESPONSE

FIRE

Small Fire

- Water spray or fog is preferred; if water not available use dry chemical, CO₂ or regular foam.

Large Fire

- Flood fire area with water from a distance.
- Use water spray or fog; avoid aiming straight or solid streams directly onto the product.
- Do not move cargo or vehicle if cargo has been exposed to heat.
- If it can be done safely, move undamaged containers away from the area around the fire.

Fire Involving Tanks, Rail Tank Cars or Highway Tanks

- Fight fire from maximum distance or use unmanned master stream devices or monitor nozzles.
- Cool containers with flooding quantities of water until well after fire is out.
- ALWAYS stay away from tanks in direct contact with flames.
- For massive fire, use unmanned master stream devices or monitor nozzles; if this is impossible, withdraw from area and let fire burn.

SPILL OR LEAK

- ELIMINATE all ignition sources (no smoking, flares, sparks or flames) from immediate area.
- Keep combustibles (wood, paper, oil, etc.) away from spilled material.
- Do not touch damaged containers or spilled material unless wearing appropriate protective clothing.
- Keep substance wet using water spray.
- Stop leak if you can do it without risk.

Small Spill

- Pick up with inert, damp, non-combustible material using clean, non-sparking tools and place into loosely covered plastic containers for later disposal.

Large Spill

- Wet down with water and dike for later disposal.
- Prevent entry into waterways, sewers, basements or confined areas.
- **DO NOT CLEAN-UP OR DISPOSE OF, EXCEPT UNDER SUPERVISION OF A SPECIALIST.**

FIRST AID

Refer to the "General First Aid" section.

Specific First Aid:

- Contaminated clothing may be a fire risk when dry.

POTENTIAL HAZARDS

FIRE OR EXPLOSION

- May explode from heat, shock, friction or contamination.
- May ignite combustibles (wood, paper, oil, clothing, etc.).
- May be ignited by heat, sparks or flames.
- May burn rapidly with flare-burning effect.
- Containers may explode when heated.
- Runoff may create fire or explosion hazard.

HEALTH

- Fire may produce irritating, corrosive and/or toxic gases.
- Ingestion or contact (skin, eyes) with substance may cause severe injury or burns.
- Runoff from fire control or dilution water may cause environmental contamination.

PUBLIC SAFETY

- **CALL 911. Then call emergency response telephone number on shipping paper.** If shipping paper not available or no answer, refer to appropriate telephone number listed on the inside back cover.
- Keep unauthorized personnel away.
- Stay upwind, uphill and/or upstream.

PROTECTIVE CLOTHING

- Wear positive pressure self-contained breathing apparatus (SCBA).
- Wear chemical protective clothing that is specifically recommended by the manufacturer **when there is NO RISK OF FIRE.**
- Structural firefighters' protective clothing provides thermal protection **but only limited chemical protection.**

EVACUATION

Immediate precautionary measure

- Isolate spill or leak area in all directions for at least 50 meters (150 feet) for liquids and at least 25 meters (75 feet) for solids.

Large Spill

- Consider initial evacuation for at least 250 meters (800 feet) in all directions.

Fire

- If tank, rail tank car or highway tank is involved in a fire, ISOLATE for 800 meters (1/2 mile) in all directions; also, consider initial evacuation for 800 meters (1/2 mile) in all directions.

EMERGENCY RESPONSE

FIRE

Small Fire

- Water spray or fog is preferred; if water not available use dry chemical, CO₂ or regular foam.

Large Fire

- Flood fire area with water from a distance.
- Use water spray or fog; avoid aiming straight or solid streams directly onto the product.
- Do not move cargo or vehicle if cargo has been exposed to heat.
- If it can be done safely, move undamaged containers away from the area around the fire.

Fire Involving Tanks, Rail Tank Cars or Highway Tanks

- Fight fire from maximum distance or use unmanned master stream devices or monitor nozzles.
- Cool containers with flooding quantities of water until well after fire is out.
- ALWAYS stay away from tanks in direct contact with flames.
- For massive fire, use unmanned master stream devices or monitor nozzles; if this is impossible, withdraw from area and let fire burn.

SPILL OR LEAK

- ELIMINATE all ignition sources (no smoking, flares, sparks or flames) from immediate area.
- Keep combustibles (wood, paper, oil, etc.) away from spilled material.
- Do not touch damaged containers or spilled material unless wearing appropriate protective clothing.
- Keep substance wet using water spray.
- Stop leak if you can do it without risk.

Small Spill

- Pick up with inert, damp, non-combustible material using clean, non-sparking tools and place into loosely covered plastic containers for later disposal.

Large Spill

- Wet down with water and dike for later disposal.
- Prevent entry into waterways, sewers, basements or confined areas.
- **DO NOT CLEAN-UP OR DISPOSE OF, EXCEPT UNDER SUPERVISION OF A SPECIALIST.**

FIRST AID

Refer to the "General First Aid" section.

Specific First Aid:

- Contaminated clothing may be a fire risk when dry.



In Canada, an Emergency Response Assistance Plan (ERAP) may be required for this product. Please consult the shipping paper and/or the "ERAP" section.

GUIDE LITHIUM ION AND SODIUM ION BATTERIES

147

POTENTIAL HAZARDS

FIRE OR EXPLOSION

- Lithium ion and sodium ion batteries contain flammable liquid electrolyte that may vent, ignite and produce sparks when subjected to high temperatures (> 150°C (302°F)), when damaged or abused (e.g., mechanical damage or electrical overcharging).
- May burn rapidly with flare-burning effect.
- May ignite other batteries in close proximity.

HEALTH

- Contact with battery electrolyte may be irritating to skin, eyes and mucous membranes.
- Fire will produce irritating, corrosive and/or toxic gases.
- Burning batteries may produce toxic hydrogen fluoride gas (see GUIDE 125).
- Fumes may cause dizziness or asphyxiation.

PUBLIC SAFETY

- **CALL 911. Then call emergency response telephone number on shipping paper.** If shipping paper not available or no answer, refer to appropriate telephone number listed on the inside back cover.
- Keep unauthorized personnel away.
- Stay upwind, uphill and/or upstream.
- Ventilate closed spaces before entering, but only if properly trained and equipped.

PROTECTIVE CLOTHING

- Wear positive pressure self-contained breathing apparatus (SCBA).
- Structural firefighters' protective clothing provides thermal protection **but only limited chemical protection.**

EVACUATION

Immediate precautionary measure

- Isolate spill or leak area for at least 25 meters (75 feet) in all directions.

Spill

- Increase the immediate precautionary measure distance, in the downwind direction, as necessary.

Fire

- If rail car or trailer is involved in a fire, ISOLATE for 500 meters (1/3 mile) in all directions; also initiate evacuation including emergency responders for 500 meters (1/3 mile) in all directions.

EMERGENCY RESPONSE

FIRE

- A lithium ion or sodium ion battery fire may reignite at any point after the initial fire is extinguished, up to weeks later.
- Use thermal imaging, if available, to continuously monitor the battery.
- Reignition can be accompanied by off-gassing of white smoke or electrical arcs or sparks that reignite with visible flames or fire.

CAUTION: The use of salt water for firefighting is not recommended since it may increase production of hydrogen and hydrogen fluoride gas.

Vehicle Fire

- If battery is not connected to a vehicle, see “Small Fire or Fire Involving Small Battery” below.
- Check manufacturer’s specific emergency response guide before attempting to disable vehicle.
- Turn off the ignition and disconnect the 12-volt battery if it can be done safely.
- Never cut the high voltage (HV) or medium voltage (MV) cabling.
- Never touch damaged or submerged HV or MV cables or components.
- If available, use **large amount of water** to extinguish or suppress a high-voltage battery fire. Using small amount of water could release toxic gases.
- If possible, spray water directly onto battery.
- DO NOT pierce, cut, pry, or dismantle any of the vehicle’s structure to access the battery. Contact with a high voltage component may cause an electric shock.

Small Fire or Fire Involving Small Battery (e.g., personal electronic devices, e-bike, etc.)

- Water spray only (large amounts); do not use dry chemical, CO₂ or Halon®.

Large Fire or Fire Involving Large Battery or Multiple Small Batteries

- Allow battery fire to burn itself out and protect surroundings.
- Safely remove undamaged containers from area.
- Apply water spray to neighboring batteries to reduce the spread of the hazard.

SPILL OR LEAK

- ELIMINATE all ignition sources (no smoking, flares, sparks or flames) from immediate area.
- Do not touch or walk through spilled material.
- Absorb with earth, sand or other non-combustible material.
- Leaking batteries and contaminated absorbent material should be placed in metal containers.

FIRST AID

Refer to the “General First Aid” section.

POTENTIAL HAZARDS**FIRE OR EXPLOSION**

- May explode from heat, contamination or loss of temperature control.
- These materials are particularly sensitive to temperature rises. Above a given "Control Temperature" they may decompose violently and catch fire.
- May ignite combustibles (wood, paper, oil, clothing, etc.).
- May ignite spontaneously if exposed to air.
- May be ignited by heat, sparks or flames.
- May burn rapidly with flare-burning effect.
- Containers may explode when heated.
- Runoff may create fire or explosion hazard.

HEALTH

- Fire may produce irritating, corrosive and/or toxic gases.
- Ingestion or contact (skin, eyes) with substance may cause severe injury or burns.
- Runoff from fire control or dilution water may cause environmental contamination.

PUBLIC SAFETY

- **CALL 911. Then call emergency response telephone number on shipping paper.** If shipping paper not available or no answer, refer to appropriate telephone number listed on the inside back cover.
- Keep unauthorized personnel away.
- Stay upwind, uphill and/or upstream.

PROTECTIVE CLOTHING

- Wear positive pressure self-contained breathing apparatus (SCBA).
- Wear chemical protective clothing that is specifically recommended by the manufacturer **when there is NO RISK OF FIRE.**
- Structural firefighters' protective clothing provides thermal protection **but only limited chemical protection.**

EVACUATION**Immediate precautionary measure**

- Isolate spill or leak area in all directions for at least 50 meters (150 feet) for liquids and at least 25 meters (75 feet) for solids.

Large Spill

- Consider initial evacuation for at least 250 meters (800 feet) in all directions.

Fire

- If tank, rail tank car or highway tank is involved in a fire, ISOLATE for 800 meters (1/2 mile) in all directions; also, consider initial evacuation for 800 meters (1/2 mile) in all directions.

EMERGENCY RESPONSE

FIRE

- The temperature of the substance must be maintained at or below the “Control Temperature” at all times.

Small Fire

- Water spray or fog is preferred; if water not available use dry chemical, CO₂ or regular foam.

Large Fire

- Flood fire area with water from a distance.
- Use water spray or fog; avoid aiming straight or solid streams directly onto the product.
- Do not move cargo or vehicle if cargo has been exposed to heat.
- If it can be done safely, move undamaged containers away from the area around the fire.

Fire Involving Tanks, Rail Tank Cars or Highway Tanks

- Fight fire from maximum distance or use unmanned master stream devices or monitor nozzles.
- Cool containers with flooding quantities of water until well after fire is out.
- **BEWARE OF POSSIBLE CONTAINER EXPLOSION.**
- ALWAYS stay away from tanks in direct contact with flames.
- For massive fire, use unmanned master stream devices or monitor nozzles; if this is impossible, withdraw from area and let fire burn.

SPILL OR LEAK

- **DO NOT allow the substance to warm up. Use a coolant agent such as dry ice or ice (wear thermal protective gloves). If this is not possible or none can be obtained, evacuate the area immediately.**
- ELIMINATE all ignition sources (no smoking, flares, sparks or flames) from immediate area.
- Keep combustibles (wood, paper, oil, etc.) away from spilled material.
- Do not touch or walk through spilled material.
- Stop leak if you can do it without risk.

Small Spill

- Pick up with inert, damp, non-combustible material using clean, non-sparking tools and place into loosely covered plastic containers for later disposal.

Large Spill

- Dike far ahead of liquid spill for later disposal.
- Prevent entry into waterways, sewers, basements or confined areas.
- **DO NOT CLEAN-UP OR DISPOSE OF, EXCEPT UNDER SUPERVISION OF A SPECIALIST.**

FIRST AID

Refer to the “General First Aid” section.

Specific First Aid:

- Contaminated clothing may be a fire risk when dry.



In Canada, an Emergency Response Assistance Plan (ERAP) may be required for this product. Please consult the shipping paper and/or the “ERAP” section.

GUIDE SUBSTANCES (SELF-REACTIVE)

149

POTENTIAL HAZARDS

FIRE OR EXPLOSION

- **Self-decomposition, self-polymerization, or self-ignition may be triggered by heat, chemical reaction, friction or impact.**
- May be ignited by heat, sparks or flames.
- Some may decompose explosively when heated or involved in a fire.
- Those substances designated with a **(P)** may polymerize explosively when heated or involved in a fire.
- May burn violently. Decomposition or polymerization may be self-accelerating and produce large amounts of gases.
- Vapors or dust may form explosive mixtures with air.

HEALTH

- Inhalation or contact with vapors, substance or decomposition products may cause severe injury or death.
- May produce irritating, toxic and/or corrosive gases.
- Runoff from fire control or dilution water may cause environmental contamination.

PUBLIC SAFETY

- **CALL 911. Then call emergency response telephone number on shipping paper.** If shipping paper not available or no answer, refer to appropriate telephone number listed on the inside back cover.
- Keep unauthorized personnel away.
- Stay upwind, uphill and/or upstream.

PROTECTIVE CLOTHING

- Wear positive pressure self-contained breathing apparatus (SCBA).
- Wear chemical protective clothing that is specifically recommended by the manufacturer **when there is NO RISK OF FIRE.**
- Structural firefighters' protective clothing provides thermal protection **but only limited chemical protection.**

EVACUATION

Immediate precautionary measure

- Isolate spill or leak area in all directions for at least 50 meters (150 feet) for liquids and at least 25 meters (75 feet) for solids.

Large Spill

- Consider initial evacuation for at least 250 meters (800 feet) in all directions.

Fire

- If tank, rail tank car or highway tank is involved in a fire, ISOLATE for 800 meters (1/2 mile) in all directions; also, consider initial evacuation for 800 meters (1/2 mile) in all directions.

EMERGENCY RESPONSE

FIRE**Small Fire**

- Dry chemical, CO₂, water spray or regular foam.

Large Fire

- Flood fire area with water from a distance.
- If it can be done safely, move undamaged containers away from the area around the fire.

Fire Involving Tanks, Rail Tank Cars or Highway Tanks

- **BEWARE OF POSSIBLE CONTAINER EXPLOSION.**
- Fight fire from maximum distance or use unmanned master stream devices or monitor nozzles.
- Cool containers with flooding quantities of water until well after fire is out.
- Withdraw immediately in case of rising sound from venting safety devices or discoloration of tank.
- ALWAYS stay away from tanks in direct contact with flames.

SPILL OR LEAK

- ELIMINATE all ignition sources (no smoking, flares, sparks or flames) from immediate area.
- Do not touch or walk through spilled material.
- Stop leak if you can do it without risk.

Small Spill

- Pick up with inert, damp, non-combustible material using clean, non-sparking tools and place into loosely covered plastic containers for later disposal.
- Prevent entry into waterways, sewers, basements or confined areas.

FIRST AID

Refer to the "General First Aid" section.



In Canada, an Emergency Response Assistance Plan (ERAP) may be required for this product. Please consult the shipping paper and/or the "ERAP" section.

POTENTIAL HAZARDS

FIRE OR EXPLOSION

- **Self-decomposition, self-polymerization, or self-ignition may be triggered by heat, chemical reaction, friction or impact.**
- Self-accelerating decomposition may occur if the specific "control temperature" is not maintained.
- These materials are particularly sensitive to temperature rises. Above a given "Control Temperature" they may decompose or polymerize violently and catch fire.
- May be ignited by heat, sparks or flames.
- Those substances designated with a (P) may polymerize explosively when heated or involved in a fire.
- Some may decompose explosively when heated or involved in a fire.
- May burn violently. Decomposition or polymerization may be self-accelerating and produce large amounts of gases.
- Vapors or dust may form explosive mixtures with air.

HEALTH

- Inhalation or contact with vapors, substance or decomposition products may cause severe injury or death.
- May produce irritating, toxic and/or corrosive gases.
- Runoff from fire control or dilution water may cause environmental contamination.

PUBLIC SAFETY

- **CALL 911. Then call emergency response telephone number on shipping paper.** If shipping paper not available or no answer, refer to appropriate telephone number listed on the inside back cover.
- Keep unauthorized personnel away.
- Stay upwind, uphill and/or upstream.

PROTECTIVE CLOTHING

- Wear positive pressure self-contained breathing apparatus (SCBA).
- Wear chemical protective clothing that is specifically recommended by the manufacturer **when there is NO RISK OF FIRE.**
- Structural firefighters' protective clothing provides thermal protection **but only limited chemical protection.**

EVACUATION

Immediate precautionary measure

- Isolate spill or leak area in all directions for at least 50 meters (150 feet) for liquids and at least 25 meters (75 feet) for solids.

Large Spill

- Consider initial evacuation for at least 250 meters (800 feet) in all directions.

Fire

- If tank, rail tank car or highway tank is involved in a fire, ISOLATE for 800 meters (1/2 mile) in all directions; also, consider initial evacuation for 800 meters (1/2 mile) in all directions.

EMERGENCY RESPONSE

FIRE

- The temperature of the substance must be maintained at or below the “Control Temperature” at all times.

Small Fire

- Dry chemical, CO₂, water spray or regular foam.

Large Fire

- Flood fire area with water from a distance.
- If it can be done safely, move undamaged containers away from the area around the fire.

Fire Involving Tanks, Rail Tank Cars or Highway Tanks

- **BEWARE OF POSSIBLE CONTAINER EXPLOSION.**
- Fight fire from maximum distance or use unmanned master stream devices or monitor nozzles.
- Cool containers with flooding quantities of water until well after fire is out.
- Withdraw immediately in case of rising sound from venting safety devices or discoloration of tank.
- ALWAYS stay away from tanks in direct contact with flames.

SPILL OR LEAK

- **DO NOT allow the substance to warm up. Use a coolant agent such as dry ice or ice (wear thermal protective gloves). If this is not possible or none can be obtained, evacuate the area immediately.**
- ELIMINATE all ignition sources (no smoking, flares, sparks or flames) from immediate area.
- Do not touch or walk through spilled material.
- Stop leak if you can do it without risk.

Small Spill

- Pick up with inert, damp, non-combustible material using clean, non-sparking tools and place into loosely covered plastic containers for later disposal.
- Prevent entry into waterways, sewers, basements or confined areas.
- **DO NOT CLEAN-UP OR DISPOSE OF, EXCEPT UNDER SUPERVISION OF A SPECIALIST.**

FIRST AID

Refer to the “General First Aid” section.



In Canada, an Emergency Response Assistance Plan (ERAP) may be required for this product. Please consult the shipping paper and/or the “ERAP” section.

GUIDE SUBSTANCES - TOXIC (NON-COMBUSTIBLE)

151

POTENTIAL HAZARDS

HEALTH

- **Highly toxic**, may be fatal if inhaled, ingested or absorbed through skin.
- Avoid any skin contact.
- Fire may produce irritating, corrosive and/or toxic gases.
- Runoff from fire control or dilution water may be corrosive and/or toxic and cause environmental contamination.

FIRE OR EXPLOSION

- Non-combustible, substance itself does not burn but may decompose upon heating to produce corrosive and/or toxic fumes.
- Containers may explode when heated.
- Runoff may pollute waterways.

PUBLIC SAFETY

- **CALL 911. Then call emergency response telephone number on shipping paper.** If shipping paper not available or no answer, refer to appropriate telephone number listed on the inside back cover.
- Keep unauthorized personnel away.
- Stay upwind, uphill and/or upstream.

PROTECTIVE CLOTHING

- Wear positive pressure self-contained breathing apparatus (SCBA).
- Wear chemical protective clothing that is specifically recommended by the manufacturer **when there is NO RISK OF FIRE.**
- Structural firefighters' protective clothing provides thermal protection **but only limited chemical protection.**

EVACUATION

Immediate precautionary measure

- Isolate spill or leak area in all directions for at least 50 meters (150 feet) for liquids and at least 25 meters (75 feet) for solids.

Spill

- For **highlighted materials**: see Table 1 - Initial Isolation and Protective Action Distances.
- For non-highlighted materials: increase the immediate precautionary measure distance, in the downwind direction, as necessary.

Fire

- If tank, rail tank car or highway tank is involved in a fire, ISOLATE for 800 meters (1/2 mile) in all directions; also, consider initial evacuation for 800 meters (1/2 mile) in all directions.

EMERGENCY RESPONSE

FIRE**Small Fire**

- Dry chemical, CO₂ or water spray.

Large Fire

- Water spray, fog or regular foam.
- If it can be done safely, move undamaged containers away from the area around the fire.
- Dike runoff from fire control for later disposal.
- Avoid aiming straight or solid streams directly onto the product.

Fire Involving Tanks, Rail Tank Cars or Highway Tanks

- Fight fire from maximum distance or use unmanned master stream devices or monitor nozzles.
- Do not get water inside containers.
- Cool containers with flooding quantities of water until well after fire is out.
- Withdraw immediately in case of rising sound from venting safety devices or discoloration of tank.
- ALWAYS stay away from tanks in direct contact with flames.
- For massive fire, use unmanned master stream devices or monitor nozzles; if this is impossible, withdraw from area and let fire burn.

SPILL OR LEAK

- Do not touch damaged containers or spilled material unless wearing appropriate protective clothing.
- Stop leak if you can do it without risk.
- Prevent entry into waterways, sewers, basements or confined areas.
- Cover with plastic sheet to prevent spreading.
- Absorb or cover with dry earth, sand or other non-combustible material and transfer to containers.
- DO NOT GET WATER INSIDE CONTAINERS.
- For solids, prevent dust cloud and avoid inhalation of dust.

FIRST AID

Refer to the "General First Aid" section.



In Canada, an Emergency Response Assistance Plan (ERAP) may be required for this product. Please consult the shipping paper and/or the "ERAP" section.

GUIDE SUBSTANCES - TOXIC (COMBUSTIBLE)

152

POTENTIAL HAZARDS

HEALTH

- **Highly toxic**, may be fatal if inhaled, ingested or absorbed through skin.
- Contact with molten substance may cause severe burns to skin and eyes.
- Avoid any skin contact.
- Fire may produce irritating, corrosive and/or toxic gases.
- Runoff from fire control or dilution water may be corrosive and/or toxic and cause environmental contamination.

FIRE OR EXPLOSION

- Combustible material: may burn but does not ignite readily.
- Containers may explode when heated.
- Those substances designated with a **(P)** may polymerize explosively when heated or involved in a fire.
- Runoff may pollute waterways.
- Substance may be transported in a molten form.

PUBLIC SAFETY

- **CALL 911. Then call emergency response telephone number on shipping paper.** If shipping paper not available or no answer, refer to appropriate telephone number listed on the inside back cover.
- Keep unauthorized personnel away.
- Stay upwind, uphill and/or upstream.

PROTECTIVE CLOTHING

- Wear positive pressure self-contained breathing apparatus (SCBA).
- Wear chemical protective clothing that is specifically recommended by the manufacturer **when there is NO RISK OF FIRE.**
- Structural firefighters' protective clothing provides thermal protection **but only limited chemical protection.**

EVACUATION

Immediate precautionary measure

- Isolate spill or leak area in all directions for at least 50 meters (150 feet) for liquids and at least 25 meters (75 feet) for solids.

Spill

- For **highlighted materials**: see Table 1 - Initial Isolation and Protective Action Distances.
- For non-highlighted materials: increase the immediate precautionary measure distance, in the downwind direction, as necessary.

Fire

- If tank, rail tank car or highway tank is involved in a fire, ISOLATE for 800 meters (1/2 mile) in all directions; also, consider initial evacuation for 800 meters (1/2 mile) in all directions.

EMERGENCY RESPONSE

FIRE**Small Fire**

- Dry chemical, CO₂ or water spray.

Large Fire

- Water spray, fog or regular foam.
- If it can be done safely, move undamaged containers away from the area around the fire.
- Dike runoff from fire control for later disposal.
- Avoid aiming straight or solid streams directly onto the product.

Fire Involving Tanks, Rail Tank Cars or Highway Tanks

- Fight fire from maximum distance or use unmanned master stream devices or monitor nozzles.
- Do not get water inside containers.
- Cool containers with flooding quantities of water until well after fire is out.
- Withdraw immediately in case of rising sound from venting safety devices or discoloration of tank.
- ALWAYS stay away from tanks in direct contact with flames.
- For massive fire, use unmanned master stream devices or monitor nozzles; if this is impossible, withdraw from area and let fire burn.

SPILL OR LEAK

- ELIMINATE all ignition sources (no smoking, flares, sparks or flames) from immediate area.
- Do not touch damaged containers or spilled material unless wearing appropriate protective clothing.
- Stop leak if you can do it without risk.
- Prevent entry into waterways, sewers, basements or confined areas.
- Cover with plastic sheet to prevent spreading.
- Absorb or cover with dry earth, sand or other non-combustible material and transfer to containers.
- DO NOT GET WATER INSIDE CONTAINERS.

FIRST AID

Refer to the "General First Aid" section.

Specific First Aid:

- Removal of solidified molten material from skin requires medical assistance.



In Canada, an Emergency Response Assistance Plan (ERAP) may be required for this product. Please consult the shipping paper and/or the "ERAP" section.

GUIDE SUBSTANCES - TOXIC AND/OR CORROSIVE 153 (COMBUSTIBLE)

POTENTIAL HAZARDS

HEALTH

- **TOXIC and/or CORROSIVE**; inhalation, ingestion or skin contact with material may cause severe injury or death.
- Methyl bromoacetate (UN2643) is an eye irritant/lachrymator (causes flow of tears).
- Contact with molten substance may cause severe burns to skin and eyes.
- Avoid any skin contact.
- Fire may produce irritating, corrosive and/or toxic gases.
- Runoff from fire control or dilution water may be corrosive and/or toxic and cause environmental contamination.

FIRE OR EXPLOSION

- Combustible material: may burn but does not ignite readily.
- When heated, vapors may form explosive mixtures with air: indoors, outdoors and sewers explosion hazards.
- Those substances designated with a **(P)** may polymerize explosively when heated or involved in a fire.
- Corrosives in contact with metals may evolve flammable hydrogen gas.
- Containers may explode when heated.
- Runoff may pollute waterways.
- Substance may be transported in a molten form.

PUBLIC SAFETY

- **CALL 911. Then call emergency response telephone number on shipping paper.** If shipping paper not available or no answer, refer to appropriate telephone number listed on the inside back cover.
- Keep unauthorized personnel away.
- Stay upwind, uphill and/or upstream.
- Ventilate closed spaces before entering, but only if properly trained and equipped.

PROTECTIVE CLOTHING

- Wear positive pressure self-contained breathing apparatus (SCBA).
- Wear chemical protective clothing that is specifically recommended by the manufacturer **when there is NO RISK OF FIRE.**
- Structural firefighters' protective clothing provides thermal protection **but only limited chemical protection.**

EVACUATION

Immediate precautionary measure

- Isolate spill or leak area in all directions for at least 50 meters (150 feet) for liquids and at least 25 meters (75 feet) for solids.

Spill

- For **highlighted materials**: see Table 1 - Initial Isolation and Protective Action Distances.
- For non-highlighted materials: increase the immediate precautionary measure distance, in the downwind direction, as necessary.

Fire

- If tank, rail tank car or highway tank is involved in a fire, ISOLATE for 800 meters (1/2 mile) in all directions; also, consider initial evacuation for 800 meters (1/2 mile) in all directions.

EMERGENCY RESPONSE

FIRE**Small Fire**

- Dry chemical, CO₂ or water spray.

Large Fire

- Dry chemical, CO₂, alcohol-resistant foam or water spray.
- If it can be done safely, move undamaged containers away from the area around the fire.
- Dike runoff from fire control for later disposal.

Fire Involving Tanks, Rail Tank Cars or Highway Tanks

- Fight fire from maximum distance or use unmanned master stream devices or monitor nozzles.
- Do not get water inside containers.
- Cool containers with flooding quantities of water until well after fire is out.
- Withdraw immediately in case of rising sound from venting safety devices or discoloration of tank.
- ALWAYS stay away from tanks in direct contact with flames.

SPILL OR LEAK

- ELIMINATE all ignition sources (no smoking, flares, sparks or flames) from immediate area.
- Do not touch damaged containers or spilled material unless wearing appropriate protective clothing.
- Stop leak if you can do it without risk.
- Prevent entry into waterways, sewers, basements or confined areas.
- Absorb or cover with dry earth, sand or other non-combustible material and transfer to containers.
- DO NOT GET WATER INSIDE CONTAINERS.

FIRST AID

Refer to the "General First Aid" section.

Specific First Aid:

- For corrosives, in case of contact, immediately flush skin or eyes with running water for at least 30 minutes. Additional flushing may be required.
- Removal of solidified molten material from skin requires medical assistance.



In Canada, an Emergency Response Assistance Plan (ERAP) may be required for this product. Please consult the shipping paper and/or the "ERAP" section.

GUIDE 154 SUBSTANCES - TOXIC AND/OR CORROSIVE (NON-COMBUSTIBLE)

POTENTIAL HAZARDS

HEALTH

- **TOXIC and/or CORROSIVE**; inhalation, ingestion or skin contact with material may cause severe injury or death.
- Contact with molten substance may cause severe burns to skin and eyes.
- Avoid any skin contact.
- Fire may produce irritating, corrosive and/or toxic gases.
- Runoff from fire control or dilution water may be corrosive and/or toxic and cause environmental contamination.

FIRE OR EXPLOSION

- Non-combustible, substance itself does not burn but may decompose upon heating to produce corrosive and/or toxic fumes.
- Some are oxidizers and may ignite combustibles (wood, paper, oil, clothing, etc.).
- Corrosives in contact with metals may evolve flammable hydrogen gas.
- Containers may explode when heated.
- For electric vehicles or equipment, GUIDE 147 (lithium ion or sodium ion batteries) or GUIDE 138 (sodium batteries) should also be consulted.

PUBLIC SAFETY

- **CALL 911. Then call emergency response telephone number on shipping paper.** If shipping paper not available or no answer, refer to appropriate telephone number listed on the inside back cover.
- Keep unauthorized personnel away.
- Stay upwind, uphill and/or upstream.
- Ventilate closed spaces before entering, but only if properly trained and equipped.

PROTECTIVE CLOTHING

- Wear positive pressure self-contained breathing apparatus (SCBA).
- Wear chemical protective clothing that is specifically recommended by the manufacturer **when there is NO RISK OF FIRE.**
- Structural firefighters' protective clothing provides thermal protection **but only limited chemical protection.**

EVACUATION

Immediate precautionary measure

- Isolate spill or leak area in all directions for at least 50 meters (150 feet) for liquids and at least 25 meters (75 feet) for solids.

Spill

- For **highlighted materials**: see Table 1 - Initial Isolation and Protective Action Distances.
- For non-highlighted materials: increase the immediate precautionary measure distance, in the downwind direction, as necessary.

Fire

- If tank, rail tank car or highway tank is involved in a fire, ISOLATE for 800 meters (1/2 mile) in all directions; also, consider initial evacuation for 800 meters (1/2 mile) in all directions.

EMERGENCY RESPONSE

FIRE**Small Fire**

- Dry chemical, CO₂ or water spray.

Large Fire

- Dry chemical, CO₂, alcohol-resistant foam or water spray.
- If it can be done safely, move undamaged containers away from the area around the fire.
- Dike runoff from fire control for later disposal.

Fire Involving Tanks, Rail Tank Cars or Highway Tanks

- Fight fire from maximum distance or use unmanned master stream devices or monitor nozzles.
- Do not get water inside containers.
- Cool containers with flooding quantities of water until well after fire is out.
- Withdraw immediately in case of rising sound from venting safety devices or discoloration of tank.
- ALWAYS stay away from tanks in direct contact with flames.

SPILL OR LEAK

- ELIMINATE all ignition sources (no smoking, flares, sparks or flames) from immediate area.
- Do not touch damaged containers or spilled material unless wearing appropriate protective clothing.
- Stop leak if you can do it without risk.
- Prevent entry into waterways, sewers, basements or confined areas.
- Absorb or cover with dry earth, sand or other non-combustible material and transfer to containers.
- DO NOT GET WATER INSIDE CONTAINERS.

FIRST AID

Refer to the "General First Aid" section.

Specific First Aid:

- For corrosives, in case of contact, immediately flush skin or eyes with running water for at least 30 minutes. Additional flushing may be required.



In Canada, an Emergency Response Assistance Plan (ERAP) may be required for this product. Please consult the shipping paper and/or the "ERAP" section.

GUIDE SUBSTANCES - TOXIC AND/OR CORROSIVE 155 (FLAMMABLE/WATER-SENSITIVE)

POTENTIAL HAZARDS

FIRE OR EXPLOSION

- **HIGHLY FLAMMABLE:** Will be easily ignited by heat, sparks or flames.
- Vapors form explosive mixtures with air: indoors, outdoors and sewers explosion hazards.
- Most vapors are heavier than air. They will spread along the ground and collect in low or confined areas (sewers, basements, tanks, etc.).
- Vapors may travel to source of ignition and flash back.
- Those substances designated with a (P) may polymerize explosively when heated or involved in a fire.
- Substance will react with water (some violently) releasing flammable, toxic or corrosive gases and runoff.
- Corrosives in contact with metals may evolve flammable hydrogen gas.
- Containers may explode when heated or if contaminated with water.

HEALTH

- **TOXIC and/or CORROSIVE;** inhalation, ingestion or contact (skin, eyes) with vapors, dusts or substance may cause severe injury, burns or death.
- **Bromoacetates and chloroacetates are extremely irritating/lachrymators (cause eye irritation and flow of tears).**
- Reaction with water or moist air may release toxic, corrosive or flammable gases.
- Reaction with water may generate much heat that will increase the concentration of fumes in the air.
- Fire will produce irritating, corrosive and/or toxic gases.
- Runoff from fire control or dilution water may be corrosive and/or toxic and cause environmental contamination.

PUBLIC SAFETY

- **CALL 911. Then call emergency response telephone number on shipping paper.** If shipping paper not available or no answer, refer to appropriate telephone number listed on the inside back cover.
- Keep unauthorized personnel away.
- Stay upwind, uphill and/or upstream.
- Ventilate closed spaces before entering, but only if properly trained and equipped.

PROTECTIVE CLOTHING

- Wear positive pressure self-contained breathing apparatus (SCBA).
- Wear chemical protective clothing that is specifically recommended by the manufacturer **when there is NO RISK OF FIRE.**
- Structural firefighters' protective clothing provides thermal protection **but only limited chemical protection.**

EVACUATION

Immediate precautionary measure

- Isolate spill or leak area in all directions for at least 50 meters (150 feet) for liquids and at least 25 meters (75 feet) for solids.

Spill

- For **highlighted materials:** see Table 1 - Initial Isolation and Protective Action Distances.
- For non-highlighted materials: increase the immediate precautionary measure distance, in the downwind direction, as necessary.

Fire

- If tank, rail tank car or highway tank is involved in a fire, ISOLATE for 800 meters (1/2 mile) in all directions; also, consider initial evacuation for 800 meters (1/2 mile) in all directions.

EMERGENCY RESPONSE

FIRE

- Note: Most foams will react with the material and release corrosive/toxic gases.

CAUTION: For Acetyl chloride (UN1717), use CO₂ or dry chemical only.

Small Fire

- CO₂, dry chemical, dry sand, alcohol-resistant foam.

Large Fire

- Water spray, fog or alcohol-resistant foam.
- **FOR CHLOROSILANES, DO NOT USE WATER;** use alcohol-resistant foam.
- If it can be done safely, move undamaged containers away from the area around the fire.
- Avoid aiming straight or solid streams directly onto the product.

Fire Involving Tanks, Rail Tank Cars or Highway Tanks

- Fight fire from maximum distance or use unmanned master stream devices or monitor nozzles.
- Do not get water inside containers.
- Cool containers with flooding quantities of water until well after fire is out.
- Withdraw immediately in case of rising sound from venting safety devices or discoloration of tank.
- ALWAYS stay away from tanks in direct contact with flames.

SPILL OR LEAK

- ELIMINATE all ignition sources (no smoking, flares, sparks or flames) from immediate area.
- All equipment used when handling the product must be grounded.
- Do not touch damaged containers or spilled material unless wearing appropriate protective clothing.
- Stop leak if you can do it without risk.
- A vapor-suppressing foam may be used to reduce vapors.
- **FOR CHLOROSILANES,** use alcohol-resistant foam to reduce vapors.
- **DO NOT GET WATER on spilled substance or inside containers.**
- Use water spray to reduce vapors or divert vapor cloud drift. Avoid allowing water runoff to contact spilled material.
- Prevent entry into waterways, sewers, basements or confined areas.

Small Spill

- Cover with DRY earth, DRY sand or other non-combustible material followed with plastic sheet to minimize spreading or contact with rain.
- Use clean, non-sparking tools to collect material and place it into loosely covered plastic containers for later disposal.

FIRST AID

Refer to the "General First Aid" section.

Specific First Aid:

- For corrosives, in case of contact, immediately flush skin or eyes with running water for at least 30 minutes. Additional flushing may be required.



In Canada, an Emergency Response Assistance Plan (ERAP) may be required for this product. Please consult the shipping paper and/or the "ERAP" section.

GUIDE 156 SUBSTANCES - TOXIC AND/OR CORROSIVE (COMBUSTIBLE/WATER-SENSITIVE)

POTENTIAL HAZARDS

FIRE OR EXPLOSION

- Combustible material: may burn but does not ignite readily.
- Substance will react with water (some violently) releasing flammable, toxic or corrosive gases and runoff.
- When heated, vapors may form explosive mixtures with air: indoors, outdoors and sewers explosion hazards.
- Most vapors are heavier than air. They will spread along the ground and collect in low or confined areas (sewers, basements, tanks, etc.).
- Vapors may travel to source of ignition and flash back.
- Corrosives in contact with metals may evolve flammable hydrogen gas.
- Containers may explode when heated or if contaminated with water.

HEALTH

- **TOXIC and/or CORROSIVE**; inhalation, ingestion or contact (skin, eyes) with vapors, dusts or substance may cause severe injury, burns or death.
- Contact with molten substance may cause severe burns to skin and eyes.
- Reaction with water or moist air may release toxic, corrosive or flammable gases.
- Reaction with water may generate much heat that will increase the concentration of fumes in the air.
- Fire will produce irritating, corrosive and/or toxic gases.
- Runoff from fire control or dilution water may be corrosive and/or toxic and cause environmental contamination.

PUBLIC SAFETY

- **CALL 911. Then call emergency response telephone number on shipping paper.** If shipping paper not available or no answer, refer to appropriate telephone number listed on the inside back cover.
- Keep unauthorized personnel away.
- Stay upwind, uphill and/or upstream.
- Ventilate closed spaces before entering, but only if properly trained and equipped.

PROTECTIVE CLOTHING

- Wear positive pressure self-contained breathing apparatus (SCBA).
- Wear chemical protective clothing that is specifically recommended by the manufacturer **when there is NO RISK OF FIRE**.
- Structural firefighters' protective clothing provides thermal protection **but only limited chemical protection**.

EVACUATION

Immediate precautionary measure

- Isolate spill or leak area in all directions for at least 50 meters (150 feet) for liquids and at least 25 meters (75 feet) for solids.

Spill

- For **highlighted materials**: see Table 1 - Initial Isolation and Protective Action Distances.
- For non-highlighted materials: increase the immediate precautionary measure distance, in the downwind direction, as necessary.

Fire

- If tank, rail tank car or highway tank is involved in a fire, ISOLATE for 800 meters (1/2 mile) in all directions; also, consider initial evacuation for 800 meters (1/2 mile) in all directions.

EMERGENCY RESPONSE

FIRE

- Note: Most foams will react with the material and release corrosive/toxic gases.

CAUTION: For Acetyl bromide (UN1716), use CO₂ or dry chemical only.

Small Fire

- CO₂, dry chemical, dry sand, alcohol-resistant foam.

Large Fire

- Water spray, fog or alcohol-resistant foam.
- **FOR CHLOROSILANES, DO NOT USE WATER;** use alcohol-resistant foam.
- If it can be done safely, move undamaged containers away from the area around the fire.
- Avoid aiming straight or solid streams directly onto the product.

Fire Involving Tanks, Rail Tank Cars or Highway Tanks

- Fight fire from maximum distance or use unmanned master stream devices or monitor nozzles.
- Do not get water inside containers.
- Cool containers with flooding quantities of water until well after fire is out.
- Withdraw immediately in case of rising sound from venting safety devices or discoloration of tank.
- ALWAYS stay away from tanks in direct contact with flames.

SPILL OR LEAK

- ELIMINATE all ignition sources (no smoking, flares, sparks or flames) from immediate area.
- All equipment used when handling the product must be grounded.
- Do not touch damaged containers or spilled material unless wearing appropriate protective clothing.
- Stop leak if you can do it without risk.
- A vapor-suppressing foam may be used to reduce vapors.
- **FOR CHLOROSILANES,** use alcohol-resistant foam to reduce vapors.
- **DO NOT GET WATER on spilled substance or inside containers.**
- Use water spray to reduce vapors or divert vapor cloud drift. Avoid allowing water runoff to contact spilled material.
- Prevent entry into waterways, sewers, basements or confined areas.

Small Spill

- Cover with DRY earth, DRY sand or other non-combustible material followed with plastic sheet to minimize spreading or contact with rain.
- Use clean, non-sparking tools to collect material and place it into loosely covered plastic containers for later disposal.

FIRST AID

Refer to the "General First Aid" section.

Specific First Aid:

- For corrosives, in case of contact, immediately flush skin or eyes with running water for at least 30 minutes. Additional flushing may be required.
- Removal of solidified molten material from skin requires medical assistance.



In Canada, an Emergency Response Assistance Plan (ERAP) may be required for this product. Please consult the shipping paper and/or the "ERAP" section.

GUIDE 157 SUBSTANCES - TOXIC AND/OR CORROSIVE (NON-COMBUSTIBLE/WATER-SENSITIVE)

POTENTIAL HAZARDS

HEALTH

- **TOXIC and/or CORROSIVE**; inhalation, ingestion or contact (skin, eyes) with vapors, dusts or substance may cause severe injury, burns or death.
- Reaction with water or moist air may release toxic, corrosive or flammable gases.
- Reaction with water may generate much heat that will increase the concentration of fumes in the air.
- Fire will produce irritating, corrosive and/or toxic gases.
- Runoff from fire control or dilution water may be corrosive and/or toxic and cause environmental contamination.

FIRE OR EXPLOSION

- Non-combustible, substance itself does not burn but may decompose upon heating to produce corrosive and/or toxic fumes.
- UN1802, UN2032, UN3084, UN3093, UN1796 (above 50%), UN1826 (above 50%), and UN2031 (above 65%) may act as oxidizers. Also consult GUIDE 140.
- Vapors may accumulate in confined areas (basement, tanks, hopper/tank cars, etc.).
- Substance may react with water (some violently), releasing corrosive and/or toxic gases and runoff.
- Corrosives in contact with metals may evolve flammable hydrogen gas.
- Containers may explode when heated or if contaminated with water.

PUBLIC SAFETY

- **CALL 911. Then call emergency response telephone number on shipping paper.** If shipping paper not available or no answer, refer to appropriate telephone number listed on the inside back cover.
- Keep unauthorized personnel away.
- Stay upwind, uphill and/or upstream.
- Ventilate closed spaces before entering, but only if properly trained and equipped.

PROTECTIVE CLOTHING

- Wear positive pressure self-contained breathing apparatus (SCBA).
- Wear chemical protective clothing that is specifically recommended by the manufacturer **when there is NO RISK OF FIRE.**
- Structural firefighters' protective clothing provides thermal protection **but only limited chemical protection.**

EVACUATION

Immediate precautionary measure

- Isolate spill or leak area in all directions for at least 50 meters (150 feet) for liquids and at least 25 meters (75 feet) for solids.

Spill

- For **highlighted materials**: see Table 1 - Initial Isolation and Protective Action Distances.
- For non-highlighted materials: increase the immediate precautionary measure distance, in the downwind direction, as necessary.

Fire

- If tank, rail tank car or highway tank is involved in a fire, ISOLATE for 800 meters (1/2 mile) in all directions; also, consider initial evacuation for 800 meters (1/2 mile) in all directions.

EMERGENCY RESPONSE

FIRE

- Note: Some foams will react with the material and release corrosive/toxic gases.

Small Fire

- CO₂ (except for Cyanides), dry chemical, dry sand, alcohol-resistant foam.

Large Fire

- Water spray, fog or alcohol-resistant foam.
- If it can be done safely, move undamaged containers away from the area around the fire.
- Avoid aiming straight or solid streams directly onto the product.
- Dike runoff from fire control for later disposal.

Fire Involving Tanks, Rail Tank Cars or Highway Tanks

- Fight fire from maximum distance or use unmanned master stream devices or monitor nozzles.
- Do not get water inside containers.
- Cool containers with flooding quantities of water until well after fire is out.
- Withdraw immediately in case of rising sound from venting safety devices or discoloration of tank.
- ALWAYS stay away from tanks in direct contact with flames.

SPILL OR LEAK

- ELIMINATE all ignition sources (no smoking, flares, sparks or flames) from immediate area.
- All equipment used when handling the product must be grounded.
- Do not touch damaged containers or spilled material unless wearing appropriate protective clothing.
- Stop leak if you can do it without risk.
- A vapor-suppressing foam may be used to reduce vapors.
- DO NOT GET WATER INSIDE CONTAINERS.
- Use water spray to reduce vapors or divert vapor cloud drift. Avoid allowing water runoff to contact spilled material.
- Prevent entry into waterways, sewers, basements or confined areas.

Small Spill

- Cover with DRY earth, DRY sand or other non-combustible material followed with plastic sheet to minimize spreading or contact with rain.
- Use clean, non-sparking tools to collect material and place it into loosely covered plastic containers for later disposal.

FIRST AID

Refer to the "General First Aid" section.

Specific First Aid:

- For corrosives, in case of contact, immediately flush skin or eyes with running water for at least 30 minutes. Additional flushing may be required.
- In case of skin contact with Hydrofluoric acid (UN1790), if calcium gluconate gel is available, rinse 5 minutes, then apply gel. Otherwise, continue rinsing until medical treatment is available.



In Canada, an Emergency Response Assistance Plan (ERAP) may be required for this product. Please consult the shipping paper and/or the "ERAP" section.

POTENTIAL HAZARDS

HEALTH

- Inhalation or contact with substance may cause infection, disease or death.
- Category A Infectious Substances (UN2814, UN2900 or UN3549) are more hazardous, or are in a more hazardous form, than infectious substances shipped as Category B Biological Substances (UN3373) or clinical waste/medical waste (UN3291).
- Runoff from fire control or dilution water may cause environmental contamination.
- Damaged packages containing solid CO₂ as a refrigerant may produce water or frost from condensation of air. Do not touch this liquid as it could be contaminated by the contents of the parcel.
- Contact with solid CO₂ may cause burns, severe injury and/or frostbite.

FIRE OR EXPLOSION

- Some of these materials may burn, but none ignite readily.
- Some may be transported in flammable liquids.

PUBLIC SAFETY

- **CALL 911. Then call emergency response telephone number on shipping paper.** If shipping paper not available or no answer, refer to appropriate telephone number listed on the inside back cover.
- Keep unauthorized personnel away.
- Stay upwind, uphill and/or upstream.
- Consult the shipping paper to identify the substance involved.

PROTECTIVE CLOTHING

- Use judgement based on the amount of material present and the possible routes of exposure to select protective clothing.
- Wear appropriate respiratory protection, such as fit-tested N95 respirator (at minimum), powered air purifying respirator (PAPR), or positive pressure self-contained breathing apparatus (SCBA).
- Wear full coverage body protection (e.g., Tyvek suit), faceshield, and disposable fluid-resistant gloves (e.g., latex or nitrile).
- Wear appropriate footwear; disposable shoe covers can be worn to protect against contamination.
- Puncture- and cut-resistant gloves should be worn over fluid-resistant gloves if sharp objects (e.g., broken glass, needles) are present.
- Wear insulated gloves (e.g. cryo gloves) over fluid-resistant gloves when handling dry ice (UN1845).
- Decontaminate protective clothing and personal protective equipment after use and before cleaning or disposal with a compatible chemical disinfectant (e.g., 10% solution of bleach, equivalent to 0.5% sodium hypochlorite) or through a validated decontamination technology (e.g., autoclave) or process.
- Structural firefighters' protective clothing provides thermal protection **but only limited chemical protection.**

EVACUATION

Immediate precautionary measure

- Isolate spill or leak area for at least 25 meters (75 feet) in all directions.

EMERGENCY RESPONSE

FIRE**Small Fire**

- Dry chemical, soda ash, lime or sand.

Large Fire

- Use extinguishing agent suitable for type of surrounding fire.
- Do not scatter spilled material with high-pressure water streams.
- If it can be done safely, move undamaged containers away from the area around the fire.

SPILL OR LEAK

- Do not touch or walk through spilled material.
- Do not touch damaged containers or spilled material unless wearing appropriate protective clothing.
- Absorb with earth, sand or other non-combustible material.
- Cover damaged package or spilled material with absorbent material such as paper towel, towel or rag to absorb any liquids, and, beginning from outside edge, pour liquid bleach or other chemical disinfectant to saturate. Keep wet with liquid bleach or other disinfectant.
- **DO NOT CLEAN-UP OR DISPOSE OF, EXCEPT UNDER SUPERVISION OF A SPECIALIST.**

FIRST AID

Refer to the "General First Aid" section.

Specific First Aid:

- Move victim to an isolated area if it can be done safely.

CAUTION: Victim may be a source of contamination.

- In case of contact with substance, immediately flush eyes with running water and wash skin thoroughly with soap and water. Take caution not to break the skin.
- Additional decontamination may also be necessary.
- Effects of exposure (inhalation, ingestion, injection/inoculation or skin contact) to substance may be delayed. Victim should consult medical professional for information regarding symptoms and treatment.



In Canada, an Emergency Response Assistance Plan (ERAP) may be required for this product. Please consult the shipping paper and/or the "ERAP" section.

GUIDE SUBSTANCES (IRRITATING)

159

POTENTIAL HAZARDS

HEALTH

- Inhalation of vapors or dust is extremely irritating.
- May cause burning of eyes and lachrymation (flow of tears).
- May cause coughing, difficult breathing and nausea.
- Brief exposure effects last only a few minutes.
- Exposure in an enclosed area may be very harmful.
- Fire will produce irritating, corrosive and/or toxic gases.
- Runoff from fire control or dilution water may cause environmental contamination.

FIRE OR EXPLOSION

- Some of these materials may burn, but none ignite readily.
- Containers may explode when heated.

PUBLIC SAFETY

- **CALL 911. Then call emergency response telephone number on shipping paper.** If shipping paper not available or no answer, refer to appropriate telephone number listed on the inside back cover.
- Keep unauthorized personnel away.
- Stay upwind, uphill and/or upstream.
- Ventilate closed spaces before entering, but only if properly trained and equipped.

PROTECTIVE CLOTHING

- Wear positive pressure self-contained breathing apparatus (SCBA).
- Wear chemical protective clothing that is specifically recommended by the manufacturer **when there is NO RISK OF FIRE.**
- Structural firefighters' protective clothing provides thermal protection **but only limited chemical protection.**

EVACUATION

Immediate precautionary measure

- Isolate spill or leak area in all directions for at least 50 meters (150 feet) for liquids and at least 25 meters (75 feet) for solids.

Large Spill

- Consider initial downwind evacuation for at least 100 meters (330 feet).

Fire

- If tank, rail tank car or highway tank is involved in a fire, ISOLATE for 800 meters (1/2 mile) in all directions; also, consider initial evacuation for 800 meters (1/2 mile) in all directions.

EMERGENCY RESPONSE**FIRE****Small Fire**

- Dry chemical, CO₂, water spray or regular foam.

Large Fire

- Water spray, fog or regular foam.
- If it can be done safely, move undamaged containers away from the area around the fire.
- Dike runoff from fire control for later disposal.

Fire Involving Tanks, Rail Tank Cars or Highway Tanks

- Fight fire from maximum distance or use unmanned master stream devices or monitor nozzles.
- Do not get water inside containers.
- Cool containers with flooding quantities of water until well after fire is out.
- Withdraw immediately in case of rising sound from venting safety devices or discoloration of tank.
- ALWAYS stay away from tanks in direct contact with flames.
- For massive fire, use unmanned master stream devices or monitor nozzles; if this is impossible, withdraw from area and let fire burn.

SPILL OR LEAK

- Do not touch or walk through spilled material.
- Stop leak if you can do it without risk.

Small Spill

- Pick up with sand or other non-combustible absorbent material and place into containers for later disposal.

Large Spill

- Dike far ahead of liquid spill for later disposal.
- Prevent entry into waterways, sewers, basements or confined areas.

FIRST AID

Refer to the "General First Aid" section.



In Canada, an Emergency Response Assistance Plan (ERAP) may be required for this product. Please consult the shipping paper and/or the "ERAP" section.

GUIDE HALOGENATED SOLVENTS

160

POTENTIAL HAZARDS

HEALTH

- Toxic by ingestion.
- Vapors may cause dizziness or asphyxiation, especially when in closed or confined areas.
- Exposure in an enclosed area may be very harmful.
- Contact may irritate or burn skin and eyes.
- Fire may produce irritating and/or toxic gases.
- Runoff from fire control or dilution water may cause environmental contamination.

FIRE OR EXPLOSION

- Some of these materials may burn, but none ignite readily.
- Most vapors are heavier than air.
- Air/vapor mixtures may explode when ignited.
- Container may explode in heat of fire.

PUBLIC SAFETY

- **CALL 911. Then call emergency response telephone number on shipping paper.** If shipping paper not available or no answer, refer to appropriate telephone number listed on the inside back cover.
- Keep unauthorized personnel away.
- Stay upwind, uphill and/or upstream.
- Many gases are heavier than air and will spread along the ground and collect in low or confined areas (sewers, basements, tanks, etc.).
- Ventilate closed spaces before entering, but only if properly trained and equipped.

PROTECTIVE CLOTHING

- Wear positive pressure self-contained breathing apparatus (SCBA).
- Wear chemical protective clothing that is specifically recommended by the manufacturer **when there is NO RISK OF FIRE.**
- Structural firefighters' protective clothing provides thermal protection **but only limited chemical protection.**

EVACUATION

Immediate precautionary measure

- Isolate spill or leak area for at least 50 meters (150 feet) in all directions.

Large Spill

- Consider initial downwind evacuation for at least 100 meters (330 feet).

Fire

- If tank, rail tank car or highway tank is involved in a fire, ISOLATE for 800 meters (1/2 mile) in all directions; also, consider initial evacuation for 800 meters (1/2 mile) in all directions.

EMERGENCY RESPONSE

FIRE**Small Fire**

- Dry chemical, CO₂ or water spray.

Large Fire

- Dry chemical, CO₂, alcohol-resistant foam or water spray.
- If it can be done safely, move undamaged containers away from the area around the fire.
- Dike runoff from fire control for later disposal.

Fire Involving Tanks, Rail Tank Cars or Highway Tanks

- Fight fire from maximum distance or use unmanned master stream devices or monitor nozzles.
- Cool containers with flooding quantities of water until well after fire is out.
- Withdraw immediately in case of rising sound from venting safety devices or discoloration of tank.
- ALWAYS stay away from tanks in direct contact with flames.

SPILL OR LEAK

- ELIMINATE all ignition sources (no smoking, flares, sparks or flames) from immediate area.
- Stop leak if you can do it without risk.

Small Liquid Spill

- Pick up with sand, earth or other non-combustible absorbent material.

Large Spill

- Dike far ahead of liquid spill for later disposal.
- Prevent entry into waterways, sewers, basements or confined areas.

FIRST AID

Refer to the "General First Aid" section.

Specific First Aid:

- Wash skin with soap and water.

GUIDE 161

RADIOACTIVE MATERIALS (LOW LEVEL RADIATION)

POTENTIAL HAZARDS

HEALTH

- Radiation presents minimal risk to transport workers, emergency response personnel and the public during transportation accidents. Packaging durability increases as potential hazard of radioactive content increases.
- Very low levels of contained radioactive materials and low radiation levels outside packages result in low risks to people. Damaged packages may release measurable amounts of radioactive material, but the resulting risks are expected to be low.
- Some radioactive materials cannot be detected by commonly available instruments.
- Packages do not have RADIOACTIVE I, II, or III labels. Some may have EMPTY labels or may have the word "Radioactive" in the package marking.

FIRE OR EXPLOSION

- Some of these materials may burn, but most do not ignite readily.
- Many have cardboard outer packaging; content (physically large or small) can be of many different physical forms.
- Radioactivity does not change flammability or other properties of materials.

PUBLIC SAFETY

- **CALL 911. Then call emergency response telephone number on shipping paper.** If shipping paper not available or no answer, refer to appropriate telephone number listed on the inside back cover.
- **Priorities for rescue, life-saving, first aid, fire control and other hazards are higher than the priority for measuring radiation levels.**
- Radiation Authority must be notified of accident conditions. Radiation Authority is usually responsible for decisions about radiological consequences and closure of emergencies.
- Stay upwind, uphill and/or upstream.
- Keep unauthorized personnel away.
- Detain or isolate uninjured persons or equipment suspected to be contaminated; delay decontamination and cleanup until instructions are received from Radiation Authority.

PROTECTIVE CLOTHING

- Positive pressure self-contained breathing apparatus (SCBA) and structural firefighters' protective clothing will provide adequate protection.

EVACUATION

Immediate precautionary measure

- Isolate spill or leak area for at least 25 meters (75 feet) in all directions.

Large Spill

- Consider initial downwind evacuation for at least 100 meters (330 feet).

Fire

- When a large quantity of this material is involved in a major fire, consider an initial evacuation distance of 300 meters (1000 feet) in all directions.

EMERGENCY RESPONSE

FIRE

- Presence of radioactive material will not influence the fire control processes and should not influence selection of techniques.
- If it can be done safely, move undamaged containers away from the area around the fire.
- Do not move damaged packages; move undamaged packages out of fire zone.

Small Fire

- Dry chemical, CO₂, water spray or regular foam.

Large Fire

- Water spray, fog (flooding amounts).

SPILL OR LEAK

- Do not touch damaged packages or spilled material.
- Cover liquid spill with sand, earth or other non-combustible absorbent material.
- Cover powder spill with plastic sheet or tarp to minimize spreading.

FIRST AID

Refer to the “General First Aid” section.

Specific First Aid:

- Medical problems take priority over radiological concerns.
- Use first aid treatment according to the nature of the injury.
- Do not delay care and transport of a seriously injured person.
- Injured persons contaminated by contact with released material are not a serious hazard to health care personnel, equipment or facilities.

GUIDE 162 RADIOACTIVE MATERIALS (LOW TO MODERATE LEVEL RADIATION)

POTENTIAL HAZARDS

HEALTH

- Radiation presents minimal risk to transport workers, emergency response personnel and the public during transportation accidents. Packaging durability increases as potential hazard of radioactive content increases.
- Undamaged packages are safe. Contents of damaged packages may cause higher external radiation exposure, or both external and internal radiation exposure if contents are released.
- Low radiation hazard when material is inside container. If material is released from package or bulk container, hazard will vary from low to moderate. Level of hazard will depend on the type and amount of radioactivity, the kind of material it is in, and/or the surfaces it is on.
- Some material may be released from packages during accidents of moderate severity but risks to people are not great.
- Released radioactive materials or contaminated objects usually will be visible if packaging fails.
- Some exclusive use shipments of bulk and packaged materials will not have RADIOACTIVE labels. Placards, markings and shipping papers provide identification.
- Some packages may have a RADIOACTIVE label and a second hazard label. The second hazard is usually greater than the radiation hazard; so follow this GUIDE as well as the response GUIDE for the second hazard class label.
- Some radioactive materials cannot be detected by commonly available instruments.
- Runoff from control of cargo fire may cause low-level pollution.

FIRE OR EXPLOSION

- Some of these materials may burn, but most do not ignite readily.
- Uranium and Thorium metal cuttings may ignite spontaneously if exposed to air (see GUIDE 136).
- Nitrates are oxidizers and may ignite other combustibles (see GUIDE 141).

PUBLIC SAFETY

- **CALL 911. Then call emergency response telephone number on shipping paper.** If shipping paper not available or no answer, refer to appropriate telephone number listed on the inside back cover.
- **Priorities for rescue, life-saving, first aid, fire control and other hazards are higher than the priority for measuring radiation levels.**
- Radiation Authority must be notified of accident conditions. Radiation Authority is usually responsible for decisions about radiological consequences and closure of emergencies.
- Stay upwind, uphill and/or upstream.
- Keep unauthorized personnel away.
- Detain or isolate uninjured persons or equipment suspected to be contaminated; delay decontamination and cleanup until instructions are received from Radiation Authority.

PROTECTIVE CLOTHING

- Positive pressure self-contained breathing apparatus (SCBA) and structural firefighters' protective clothing will provide adequate protection.

EVACUATION

Immediate precautionary measure

- Isolate spill or leak area for at least 25 meters (75 feet) in all directions.

Large Spill

- Consider initial downwind evacuation for at least 100 meters (330 feet).

Fire

- When a large quantity of this material is involved in a major fire, consider an initial evacuation distance of 300 meters (1000 feet) in all directions.

EMERGENCY RESPONSE

FIRE

- Presence of radioactive material will not influence the fire control processes and should not influence selection of techniques.
- If it can be done safely, move undamaged containers away from the area around the fire.
- Do not move damaged packages; move undamaged packages out of fire zone.

Small Fire

- Dry chemical, CO₂, water spray or regular foam.

Large Fire

- Water spray, fog (flooding amounts).
- Dike runoff from fire control for later disposal.

SPILL OR LEAK

- Do not touch damaged packages or spilled material.
- Cover liquid spill with sand, earth or other non-combustible absorbent material.
- Dike to collect large liquid spills.
- Cover powder spill with plastic sheet or tarp to minimize spreading.

FIRST AID

Refer to the “General First Aid” section.

Specific First Aid:

- Medical problems take priority over radiological concerns.
- Use first aid treatment according to the nature of the injury.
- Do not delay care and transport of a seriously injured person.
- In case of contact with substance, wipe from skin immediately; flush skin or eyes with running water for at least 20 minutes.
- Injured persons contaminated by contact with released material are not a serious hazard to health care personnel, equipment or facilities.



In Canada, an Emergency Response Assistance Plan (ERAP) may be required for this product. Please consult the shipping paper and/or the "ERAP" section.

GUIDE 163 RADIOACTIVE MATERIALS (LOW TO HIGH LEVEL RADIATION)

POTENTIAL HAZARDS

HEALTH

- Radiation presents minimal risk to transport workers, emergency response personnel and the public during transportation accidents. Packaging durability increases as potential hazard of radioactive content increases.
- Undamaged packages are safe. Contents of damaged packages may cause higher external radiation exposure, or both external and internal radiation exposure if contents are released.
- Type A packages (cartons, boxes, drums, articles, etc.) identified as Type A by marking on packages or by shipping papers contain non-life-endangering amounts. Partial releases might be expected if Type A packages are damaged in moderately severe accidents.
- Type B packages, and the rarely occurring Type C packages (large and small, usually metal), contain the most hazardous amounts. They can be identified by package markings or by shipping papers. Life-threatening conditions may exist only if contents are released or package shielding fails. Because of design, evaluation and testing of packages, these conditions would be expected only for accidents of utmost severity.
- The rarely occurring "Special Arrangement" shipments may be of Type A, Type B or Type C packages. Package type will be marked on packages, and shipment details will be on shipping papers.
- Radioactive White-I labels indicate radiation levels outside single, isolated, undamaged packages are very low (less than 0.005 mSv/h (0.5 mrem/h)).
- Radioactive Yellow-II and Yellow-III labeled packages have higher radiation levels. The transport index (TI) on the label identifies the maximum radiation level in mrem/h one meter from a single, isolated, undamaged package.
- Some radioactive materials cannot be detected by commonly available instruments.
- Water from cargo fire control may cause pollution.

FIRE OR EXPLOSION

- Some of these materials may burn, but most do not ignite readily.
- Radioactivity does not change flammability or other properties of materials.
- Type B packages are designed and evaluated to withstand total engulfment in flames at temperatures of 800°C (1475°F) for a period of 30 minutes.

PUBLIC SAFETY

- **CALL 911. Then call emergency response telephone number on shipping paper.** If shipping paper not available or no answer, refer to appropriate telephone number listed on the inside back cover.
- **Priorities for rescue, life-saving, first aid, fire control and other hazards are higher than the priority for measuring radiation levels.**
- Radiation Authority must be notified of accident conditions. Radiation Authority is usually responsible for decisions about radiological consequences and closure of emergencies.
- Stay upwind, uphill and/or upstream. • Keep unauthorized personnel away.
- Detain or isolate uninjured persons or equipment suspected to be contaminated; delay decontamination and cleanup until instructions are received from Radiation Authority.

PROTECTIVE CLOTHING

- Positive pressure self-contained breathing apparatus (SCBA) and structural firefighters' protective clothing will provide adequate protection against internal radiation exposure, but not external radiation exposure.

EVACUATION

Immediate precautionary measure

- Isolate spill or leak area for at least 25 meters (75 feet) in all directions.

Large Spill

- Consider initial downwind evacuation for at least 100 meters (330 feet).

Fire

- When a large quantity of this material is involved in a major fire, consider an initial evacuation distance of 300 meters (1000 feet) in all directions.

EMERGENCY RESPONSE

FIRE

- Presence of radioactive material will not influence the fire control processes and should not influence selection of techniques.
- If it can be done safely, move undamaged containers away from the area around the fire.
- Do not move damaged packages; move undamaged packages out of fire zone.

Small Fire

- Dry chemical, CO₂, water spray or regular foam.

Large Fire

- Water spray, fog (flooding amounts).
- Dike runoff from fire control for later disposal.

SPILL OR LEAK

- Do not touch damaged packages or spilled material.
- Damp surfaces on undamaged or slightly damaged packages are seldom an indication of packaging failure. Most packaging for liquid content have inner containers and/or inner absorbent materials.
- Cover liquid spill with sand, earth or other non-combustible absorbent material.

FIRST AID

Refer to the “General First Aid” section.

Specific First Aid:

- Medical problems take priority over radiological concerns.
- Use first aid treatment according to the nature of the injury.
- Do not delay care and transport of a seriously injured person.
- Injured persons contaminated by contact with released material are not a serious hazard to health care personnel, equipment or facilities.

POTENTIAL HAZARDS

HEALTH

- Radiation presents minimal risk to transport workers, emergency response personnel and the public during transportation accidents. Packaging durability increases as potential hazard of radioactive content increases.
- Undamaged packages are safe; contents of damaged packages may cause external radiation exposure, and much higher external exposure if contents (source capsules) are released.
- Contamination and internal radiation hazards are not expected, but not impossible.
- Type A packages (cartons, boxes, drums, articles, etc.) identified as Type A by marking on packages or by shipping papers contain non-life-endangering amounts. Radioactive sources may be released if Type A packages are damaged in moderately severe accidents.
- Type B packages, and the rarely occurring Type C packages, (large and small, usually metal) contain the most hazardous amounts. They can be identified by package markings or by shipping papers. Life-threatening conditions may exist only if contents are released or package shielding fails. Because of design, evaluation and testing of packages, these conditions would be expected only for accidents of utmost severity.
- Radioactive White-I labels indicate radiation levels outside single, isolated, undamaged packages are very low (less than 0.005 mSv/h (0.5 mrem/h)).
- Radioactive Yellow-II and Yellow-III labeled packages have higher radiation levels. The transport index (TI) on the label identifies the maximum radiation level in mrem/h one meter from a single, isolated, undamaged package.
- Radiation from the package contents, usually in durable metal capsules, can be detected by most radiation instruments.
- Water from cargo fire control is not expected to cause pollution.

FIRE OR EXPLOSION

- Packagings can burn completely without risk of content loss from sealed source capsule.
- Radioactivity does not change flammability or other properties of materials.
- Radioactive source capsules and Type B packages are designed and evaluated to withstand total engulfment in flames at temperatures of 800°C (1475°F) for a period of 30 minutes.

PUBLIC SAFETY

- **CALL 911. Then call emergency response telephone number on shipping paper.** If shipping paper not available or no answer, refer to appropriate telephone number listed on the inside back cover.
- **Priorities for rescue, life-saving, first aid, fire control and other hazards are higher than the priority for measuring radiation levels.**
- Radiation Authority must be notified of accident conditions. Radiation Authority is usually responsible for decisions about radiological consequences and closure of emergencies.
- Stay upwind, uphill and/or upstream. • Keep unauthorized personnel away.
- Delay final cleanup until instructions or advice is received from Radiation Authority.

PROTECTIVE CLOTHING

- Positive pressure self-contained breathing apparatus (SCBA) and structural firefighters' protective clothing will provide adequate protection against internal radiation exposure, but not external radiation exposure.

EVACUATION

Immediate precautionary measure

- Isolate spill or leak area for at least 25 meters (75 feet) in all directions.

Large Spill

- Consider initial downwind evacuation for at least 100 meters (330 feet).

Fire

- When a large quantity of this material is involved in a major fire, consider an initial evacuation distance of 300 meters (1000 feet) in all directions.

EMERGENCY RESPONSE

FIRE

- Presence of radioactive material will not influence the fire control processes and should not influence selection of techniques.
- If it can be done safely, move undamaged containers away from the area around the fire.
- Do not move damaged packages; move undamaged packages out of fire zone.

Small Fire

- Dry chemical, CO₂, water spray or regular foam.

Large Fire

- Water spray, fog (flooding amounts).

SPILL OR LEAK

- Do not touch damaged packages or spilled material.
- Damp surfaces on undamaged or slightly damaged packages are seldom an indication of packaging failure. Contents are seldom liquid. Content is usually a metal capsule, easily seen if released from package.
- If source capsule is identified as being out of package, **DO NOT TOUCH**. Stay away and await advice from Radiation Authority.

FIRST AID

Refer to the “General First Aid” section.

Specific First Aid:

- Medical problems take priority over radiological concerns.
- Use first aid treatment according to the nature of the injury.
- Do not delay care and transport of a seriously injured person.
- Persons exposed to special form sources are not likely to be contaminated with radioactive material.
- Injured persons contaminated by contact with released material are not a serious hazard to health care personnel, equipment or facilities.

GUIDE 165 RADIOACTIVE MATERIALS (FISSILE/LOW TO HIGH LEVEL RADIATION)

POTENTIAL HAZARDS

HEALTH

- Radiation presents minimal risk to transport workers, emergency response personnel and the public during transportation accidents. Packaging durability increases as potential hazard of radioactive content increases.
- Undamaged packages are safe. Contents of damaged packages may cause higher external radiation exposure, or both external and internal radiation exposure if contents are released.
- Type AF or IF packages, identified by package markings, do not contain life-threatening amounts of material. External radiation levels are low and packages are designed, evaluated and tested to control releases and to prevent a fission chain reaction under severe transport conditions.
- Type B(U)F, B(M)F and CF packages (identified by markings on packages or shipping papers) contain potentially life-endangering amounts. Because of design, evaluation and testing of packages, fission chain reactions are prevented and releases are not expected to be life-endangering for all accidents except those of utmost severity.
- The rarely occurring "Special Arrangement" shipments may be of Type AF, BF or CF packages. Package type will be marked on packages, and shipment details will be on shipping papers.
- The transport index (TI) shown on labels or a shipping paper might not indicate the radiation level at one meter from a single, isolated, undamaged package; instead, it might relate to controls needed during transport because of the fissile properties of the materials. Alternatively, the fissile nature of the contents is indicated by a criticality safety index (CSI) on a special FISSILE label or on the shipping paper.
- Some radioactive materials cannot be detected by commonly available instruments.
- Water from cargo fire control is not expected to cause pollution.

FIRE OR EXPLOSION

- These materials are seldom flammable. Packages are designed to withstand fires without damage to contents.
- Radioactivity does not change flammability or other properties of materials.
- Type AF, IF, B(U)F, B(M)F and CF packages are designed and evaluated to withstand total engulfment in flames at temperatures of 800°C (1475°F) for a period of 30 minutes.

PUBLIC SAFETY

- **CALL 911. Then call emergency response telephone number on shipping paper.** If shipping paper not available or no answer, refer to appropriate telephone number listed on the inside back cover.
- **Priorities for rescue, life-saving, first aid, fire control and other hazards are higher than the priority for measuring radiation levels.**
- Radiation Authority must be notified of accident conditions. Radiation Authority is usually responsible for decisions about radiological consequences and closure of emergencies.
- Stay upwind, uphill and/or upstream.
- Keep unauthorized personnel away.
- Detain or isolate uninjured persons or equipment suspected to be contaminated; delay decontamination and cleanup until instructions are received from Radiation Authority.

PROTECTIVE CLOTHING

- Positive pressure self-contained breathing apparatus (SCBA) and structural firefighters' protective clothing will provide adequate protection against internal radiation exposure, but not external radiation exposure.

EVACUATION

Immediate precautionary measure

- Isolate spill or leak area for at least 25 meters (75 feet) in all directions.

Large Spill

- Consider initial downwind evacuation for at least 100 meters (330 feet).

Fire

- When a large quantity of this material is involved in a major fire, consider an initial evacuation distance of 300 meters (1000 feet) in all directions.

EMERGENCY RESPONSE

FIRE

- Presence of radioactive material will not influence the fire control processes and should not influence selection of techniques.
- If it can be done safely, move undamaged containers away from the area around the fire.
- Do not move damaged packages; move undamaged packages out of fire zone.

Small Fire

- Dry chemical, CO₂, water spray or regular foam.

Large Fire

- Water spray, fog (flooding amounts).

SPILL OR LEAK

- Do not touch damaged packages or spilled material.
- Damp surfaces on undamaged or slightly damaged packages are seldom an indication of packaging failure. Most packaging for liquid content have inner containers and/or inner absorbent materials.

Liquid Spill

- Package contents are seldom liquid. If any radioactive contamination resulting from a liquid release is present, it probably will be low-level.

FIRST AID

Refer to the "General First Aid" section.

Specific First Aid:

- Medical problems take priority over radiological concerns.
- Use first aid treatment according to the nature of the injury.
- Do not delay care and transport of a seriously injured person.
- Injured persons contaminated by contact with released material are not a serious hazard to health care personnel, equipment or facilities.



In Canada, an Emergency Response Assistance Plan (ERAP) may be required for this product. Please consult the shipping paper and/or the "ERAP" section.

GUIDE 166 RADIOACTIVE MATERIALS - CORROSIVE (URANIUM HEXAFLUORIDE/WATER-REACTIVE)

POTENTIAL HAZARDS

HEALTH

- Radiation presents minimal risk to transport workers, emergency response personnel and the public during transportation accidents. Packaging durability increases as potential hazard of radioactive content increases.
- Low radiation hazard to people. **Chemical hazard greatly exceeds radiation hazard.**
- Substance reacts with water and water vapor in air to form **toxic and corrosive hydrogen fluoride gas, hydrofluoric acid**, and an extremely irritating and corrosive, white-colored, water-soluble residue.
- **Toxic; may be fatal if inhaled, ingested, or absorbed through skin.**
- Direct contact with substance and gas may cause burns to skin, eyes, or respiratory tract.
- Runoff from control of cargo fire may cause low-level pollution.

FIRE OR EXPLOSION

- Substance does not burn.
- The material may react violently with fuels.
- Product will decompose to produce toxic and/or corrosive fumes.
- Containers in protective overpacks (horizontal cylindrical shape with short legs for tie-downs), are identified with AF, B(U)F or H(U) on shipping papers or by markings on the overpacks. They are designed and evaluated to withstand severe conditions including total engulfment in flames at temperatures of 800°C (1475°F) for a period of 30 minutes.
- Bare filled cylinders, identified with UN2978 as part of the marking (may also be marked H(U) or H(M)), may rupture in heat of engulfing fire; bare empty (except for residue) cylinders will not rupture in fires.
- Radioactivity does not change flammability or other properties of materials.

PUBLIC SAFETY

- **CALL 911. Then call emergency response telephone number on shipping paper.** If shipping paper not available or no answer, refer to appropriate telephone number listed on the inside back cover.
- **Priorities for rescue, life-saving, first aid, fire control and other hazards are higher than the priority for measuring radiation levels.**
- Radiation Authority must be notified of accident conditions. Radiation Authority is usually responsible for decisions about radiological consequences and closure of emergencies.
- Stay upwind, uphill and/or upstream.
- Keep unauthorized personnel away.
- Detain or isolate uninjured persons or equipment suspected to be contaminated; delay decontamination and cleanup until instructions are received from Radiation Authority.

PROTECTIVE CLOTHING

- Wear positive pressure self-contained breathing apparatus (SCBA).
- Wear chemical protective clothing that is specifically recommended by the manufacturer **when there is NO RISK OF FIRE.**
- Structural firefighters' protective clothing provides thermal protection **but only limited chemical protection.**

EVACUATION

Immediate precautionary measure

- Isolate spill or leak area for at least 25 meters (75 feet) in all directions.

Spill

- See [Table 1 - Initial Isolation and Protective Action Distances](#).

Fire

- When a large quantity of this material is involved in a major fire, consider an initial evacuation distance of 300 meters (1000 feet) in all directions.

EMERGENCY RESPONSE

FIRE

- DO NOT USE WATER OR FOAM ON MATERIAL ITSELF.
- If it can be done safely, move undamaged containers away from the area around the fire.

Small Fire

- Dry chemical or CO₂.

Large Fire

- Dry chemical, CO₂, or withdraw from area and let fire burn.
- Only use water if the package is intact.
- DO NOT GET WATER on spilled substance or inside containers.
- ALWAYS stay away from tanks in direct contact with flames.
- Fight fire from maximum distance or use unmanned master stream devices or monitor nozzles.

SPILL OR LEAK

- Do not touch damaged packages or spilled material.
- **DO NOT GET WATER** on spilled substance or inside containers.
- Without fire or smoke, leak will be evident by visible and irritating vapors and residue forming at the point of release.
- Use water spray to reduce vapors or divert vapor cloud drift. Avoid allowing water runoff to contact spilled material.
- Residue buildup may self-seal small leaks.
- Dike far ahead of spill to collect runoff water.

FIRST AID

Refer to the "General First Aid" section.

Specific First Aid:

- Medical problems take priority over radiological concerns.
- Use first aid treatment according to the nature of the injury.
- **In case of skin contact with hydrogen fluoride gas and/or Hydrofluoric acid**, if calcium gluconate gel is available, rinse 5 minutes, then apply gel. Otherwise, continue rinsing until medical treatment is available.
- Do not delay care and transport of a seriously injured person.



In Canada, an Emergency Response Assistance Plan (ERAP) may be required for this product. Please consult the shipping paper and/or the "ERAP" section.

Intentionally left blank

There are no materials that refer to this guide.

Intentionally left blank

There are no materials that refer to this guide.

GUIDE CARBON MONOXIDE (REFRIGERATED LIQUID)

168

POTENTIAL HAZARDS

HEALTH

- **TOXIC; Extremely Hazardous.**
- Inhalation extremely dangerous; may be fatal.
- Contact with gas, liquefied gas or cryogenic liquids may cause burns, severe injury and/or frostbite.
- Odorless, will not be detected by sense of smell.

FIRE OR EXPLOSION

- **EXTREMELY FLAMMABLE.**
- **CAUTION: Flame can be invisible. Use an alternate method of detection (thermal camera, broom handle, etc.)**
- May be ignited by heat, sparks or flames.
- Containers may explode when heated.
- Vapor explosion and poison hazard indoors, outdoors or in sewers.
- Vapors from liquefied gas are initially heavier than air and spread along ground.
- Vapors may travel to source of ignition and flash back.
- Runoff may create fire or explosion hazard.

PUBLIC SAFETY

- **CALL 911. Then call emergency response telephone number on shipping paper.** If shipping paper not available or no answer, refer to appropriate telephone number listed on the inside back cover.
- Keep unauthorized personnel away.
- Stay upwind, uphill and/or upstream.
- Many gases are heavier than air and will spread along the ground and collect in low or confined areas (sewers, basements, tanks, etc.).
- Ventilate closed spaces before entering, but only if properly trained and equipped.

PROTECTIVE CLOTHING

- Wear positive pressure self-contained breathing apparatus (SCBA).
- Wear chemical protective clothing that is specifically recommended by the manufacturer **when there is NO RISK OF FIRE.**
- Structural firefighters' protective clothing provides thermal protection **but only limited chemical protection.**
- Always wear thermal protective clothing when handling refrigerated/cryogenic liquids.

EVACUATION

Immediate precautionary measure

- Isolate spill or leak area for at least 100 meters (330 feet) in all directions.

Spill

- See [Table 1 - Initial Isolation and Protective Action Distances](#).

Fire

- If tank, rail tank car or highway tank is involved in a fire, ISOLATE for 800 meters (1/2 mile) in all directions; also, consider initial evacuation for 800 meters (1/2 mile) in all directions.

EMERGENCY RESPONSE

FIRE

CAUTION: Flame can be invisible. Use an alternate method of detection (thermal camera, broom handle, etc.)

- **DO NOT EXTINGUISH A LEAKING GAS FIRE UNLESS LEAK CAN BE STOPPED.**

Small Fire

- Dry chemical, CO₂ or water spray.

Large Fire

- Water spray, fog or regular foam.
- If it can be done safely, move undamaged containers away from the area around the fire.

Fire Involving Tanks

- Fight fire from maximum distance or use unmanned master stream devices or monitor nozzles.
- Cool containers with flooding quantities of water until well after fire is out.
- Do not direct water at source of leak or safety devices; icing may occur.
- Withdraw immediately in case of rising sound from venting safety devices or discoloration of tank.
- ALWAYS stay away from tanks in direct contact with flames.

SPILL OR LEAK

- ELIMINATE all ignition sources (no smoking, flares, sparks or flames) from immediate area.
- All equipment used when handling the product must be grounded.
- Do not touch or walk through spilled material.
- Stop leak if you can do it without risk.
- Use water spray to reduce vapors or divert vapor cloud drift. Avoid allowing water runoff to contact spilled material.
- Do not direct water at spill or source of leak.
- If possible, turn leaking containers so that gas escapes rather than liquid.
- Prevent entry into waterways, sewers, basements or confined areas.
- Isolate area until gas has dispersed.

FIRST AID

Refer to the “General First Aid” section.

Specific First Aid:

- In case of contact with liquefied gas, only medical personnel should attempt thawing frosted parts.

GUIDE ALUMINUM (MOLTEN)

169

POTENTIAL HAZARDS

FIRE OR EXPLOSION

- Substance is transported in molten form at a temperature above 705°C (1300°F).
- Violent reaction with water; contact may cause an explosion or may produce a flammable gas.
- Will ignite combustible materials (wood, paper, oil, debris, etc.).
- Contact with nitrates or other oxidizers may cause an explosion.
- Contact with containers or other materials, including cold, wet or dirty tools, may cause an explosion.
- Contact with concrete will cause spalling and small pops.

HEALTH

- Contact causes severe burns to skin and eyes.
- Fire may produce irritating and/or toxic gases.

PUBLIC SAFETY

- **CALL 911. Then call emergency response telephone number on shipping paper.** If shipping paper not available or no answer, refer to appropriate telephone number listed on the inside back cover.
- Stay upwind, uphill and/or upstream.
- Keep unauthorized personnel away.
- Ventilate closed spaces before entering, but only if properly trained and equipped.

PROTECTIVE CLOTHING

- Wear positive pressure self-contained breathing apparatus (SCBA).
- Wear flame-retardant structural firefighters' protective clothing, including faceshield, helmet and gloves, as this will provide limited thermal protection.

EVACUATION

Immediate precautionary measure

- Isolate spill or leak area for at least 50 meters (150 feet) in all directions.

EMERGENCY RESPONSE

FIRE

- Do not use water, except in life-threatening situations and then only in a fine spray.
- Do not use halogenated extinguishing agents or foam.
- Move combustibles out of path of advancing pool if you can do so without risk.
- Extinguish fires started by molten material by using appropriate method for the burning material; keep water, halogenated extinguishing agents and foam away from the molten material.

SPILL OR LEAK

- Do not touch or walk through spilled material.
- Do not attempt to stop leak, due to danger of explosion.
- Keep combustibles (wood, paper, oil, etc.) away from spilled material.
- Substance is very fluid, spreads quickly, and may splash. Do not try to stop it with shovels or other objects.
- Dike far ahead of spill; use dry sand to contain the flow of material.
- Where possible allow molten material to solidify naturally.
- Avoid contact even after material solidifies. Molten, heated and cold aluminum look alike; do not touch unless you know it is cold.
- Clean up under the supervision of an expert after material has solidified.

FIRST AID

Refer to the “General First Aid” section.

Specific First Aid:

- Removal of solidified molten material from skin requires medical assistance.

POTENTIAL HAZARDS

FIRE OR EXPLOSION

- May react violently or explosively on contact with water.
- Some are transported in flammable liquids.
- May be ignited by friction, heat, sparks or flames.
- Some of these materials will burn with intense heat.
- Dusts or fumes may form explosive mixtures in air.
- Containers may explode when heated.
- May re-ignite after fire is extinguished.

HEALTH

- Oxides from metallic fires are a severe health hazard.
- Inhalation or contact with substance or decomposition products may cause severe injury or death.
- Fire may produce irritating, corrosive and/or toxic gases.
- Runoff from fire control or dilution water may cause environmental contamination.

PUBLIC SAFETY

- **CALL 911. Then call emergency response telephone number on shipping paper.** If shipping paper not available or no answer, refer to appropriate telephone number listed on the inside back cover.
- Stay upwind, uphill and/or upstream.
- Keep unauthorized personnel away.

PROTECTIVE CLOTHING

- Wear positive pressure self-contained breathing apparatus (SCBA).
- Structural firefighters' protective clothing provides thermal protection **but only limited chemical protection.**

EVACUATION

Immediate precautionary measure

- Isolate spill or leak area in all directions for at least 50 meters (150 feet) for liquids and at least 25 meters (75 feet) for solids.

Large Spill

- Consider initial downwind evacuation for at least 50 meters (160 feet).

Fire

- If tank, rail tank car or highway tank is involved in a fire, ISOLATE for 800 meters (1/2 mile) in all directions; also, consider initial evacuation for 800 meters (1/2 mile) in all directions.

EMERGENCY RESPONSE

FIRE

- **DO NOT USE WATER, FOAM OR CO₂.**
- Dousing metallic fires with water will generate hydrogen gas, an extremely dangerous explosion hazard, particularly if fire is in a confined environment (i.e., building, cargo hold, etc.).
- Use DRY sand, graphite powder, dry sodium chloride-based extinguishers, or class D extinguishers.
- Confining and smothering metal fires is preferable rather than applying water.
- If it can be done safely, move undamaged containers away from the area around the fire.

Fire Involving Tanks, Rail Tank Cars or Highway Tanks

- If impossible to extinguish, protect surroundings and allow fire to burn itself out.

SPILL OR LEAK

- **ELIMINATE** all ignition sources (no smoking, flares, sparks or flames) from immediate area.
- Do not touch or walk through spilled material.
- Stop leak if you can do it without risk.
- Prevent entry into waterways, sewers, basements or confined areas.

FIRST AID

Refer to the “General First Aid” section.



In Canada, an Emergency Response Assistance Plan (ERAP) may be required for this product. Please consult the shipping paper and/or the "ERAP" section.

GUIDE SUBSTANCES (LOW TO MODERATE HAZARD)

171

POTENTIAL HAZARDS

FIRE OR EXPLOSION

- Some may burn but none ignite readily.
- Containers may explode when heated.
- Some may be transported hot.
- For UN3508, Capacitor, asymmetric, be aware of possible short circuiting as this product is transported in a charged state.
- Polymeric beads, expandable (UN2211) may evolve flammable vapours.

HEALTH

- Inhalation of material may be harmful.
- Contact may cause burns to skin and eyes.
- Inhalation of Asbestos dust may have a damaging effect on the lungs.
- Fire may produce irritating, corrosive and/or toxic gases.
- Some liquids produce vapors that may cause dizziness or asphyxiation.
- Runoff from fire control or dilution water may cause environmental contamination.

PUBLIC SAFETY

- **CALL 911. Then call emergency response telephone number on shipping paper.** If shipping paper not available or no answer, refer to appropriate telephone number listed on the inside back cover.
- Keep unauthorized personnel away.
- Stay upwind, uphill and/or upstream.

PROTECTIVE CLOTHING

- Wear positive pressure self-contained breathing apparatus (SCBA).
- Structural firefighters' protective clothing provides thermal protection **but only limited chemical protection.**

EVACUATION

Immediate precautionary measure

- Isolate spill or leak area in all directions for at least 50 meters (150 feet) for liquids and at least 25 meters (75 feet) for solids.

Spill

- For **highlighted materials**: see Table 1 - Initial Isolation and Protective Action Distances.
- For non-highlighted materials: increase the immediate precautionary measure distance, in the downwind direction, as necessary.

Fire

- If tank, rail tank car or highway tank is involved in a fire, ISOLATE for 800 meters (1/2 mile) in all directions; also, consider initial evacuation for 800 meters (1/2 mile) in all directions.

EMERGENCY RESPONSE

FIRE

CAUTION: Fire involving Safety devices (UN3268) and Fire suppressant dispersing devices (UN3559) may have a delayed activation and a risk of hazardous projectiles. Extinguish the fire at a safe distance.

Small Fire

- Dry chemical, CO₂, water spray or regular foam.

Large Fire

- Water spray, fog or regular foam.
- Do not scatter spilled material with high-pressure water streams.
- If it can be done safely, move undamaged containers away from the area around the fire.
- Dike runoff from fire control for later disposal.

Fire Involving Tanks

- Cool containers with flooding quantities of water until well after fire is out.
- Withdraw immediately in case of rising sound from venting safety devices or discoloration of tank.
- ALWAYS stay away from tanks in direct contact with flames.

SPILL OR LEAK

- Do not touch or walk through spilled material.
- Stop leak if you can do it without risk.
- Prevent dust cloud.
- For Asbestos, avoid inhalation of dust. Cover spill with plastic sheet or tarp to minimize spreading. Do not clean up or dispose of, except under supervision of a specialist.

Small Dry Spill

- With clean shovel, place material into clean, dry container and cover loosely; move containers from spill area.

Small Spill

- Pick up with sand or other non-combustible absorbent material and place into containers for later disposal.

Large Spill

- Dike far ahead of liquid spill for later disposal.
- Cover powder spill with plastic sheet or tarp to minimize spreading.
- Prevent entry into waterways, sewers, basements or confined areas.

FIRST AID

Refer to the "General First Aid" section.

GUIDE GALLIUM AND MERCURY

172

POTENTIAL HAZARDS

HEALTH

- Inhalation of vapors or contact with substance will result in contamination and potential harmful effects.
- Fire will produce irritating, corrosive and/or toxic gases.

FIRE OR EXPLOSION

- Non-combustible, substance itself does not burn but may react upon heating to produce corrosive and/or toxic fumes.
- Runoff may pollute waterways.

PUBLIC SAFETY

- **CALL 911. Then call emergency response telephone number on shipping paper.** If shipping paper not available or no answer, refer to appropriate telephone number listed on the inside back cover.
- Stay upwind, uphill and/or upstream.
- Keep unauthorized personnel away.

PROTECTIVE CLOTHING

- Wear positive pressure self-contained breathing apparatus (SCBA).
- Structural firefighters' protective clothing provides thermal protection **but only limited chemical protection.**

EVACUATION

Immediate precautionary measure

- Isolate spill or leak area for at least 50 meters (150 feet) in all directions.

Large Spill

- Consider initial downwind evacuation for at least 100 meters (330 feet).

Fire

- When any large container is involved in a fire, consider initial evacuation for 500 meters (1/3 mile) in all directions.

EMERGENCY RESPONSE**FIRE**

- Use extinguishing agent suitable for type of surrounding fire.
- **Do not direct water at the heated metal.**

SPILL OR LEAK

- Do not touch or walk through spilled material.
- Do not touch damaged containers or spilled material unless wearing appropriate protective clothing.
- Stop leak if you can do it without risk.
- Prevent entry into waterways, sewers, basements or confined areas.
- Do not use steel or aluminum tools or equipment.
- Cover with earth, sand or other non-combustible material followed with plastic sheet to minimize spreading or contact with rain.
- For mercury, use a mercury spill kit.
- Mercury spill areas may be subsequently treated with calcium sulphide/calcium sulfide or with sodium thiosulphate/sodium thiosulfate wash to neutralize any residual mercury.

FIRST AID

Refer to the “General First Aid” section.

POTENTIAL HAZARDS

HEALTH

- **TOXIC; may be fatal if inhaled or absorbed through skin.**
- Vapors may be irritating.
- Contact with gas may cause burns and injury.
- Fire will produce irritating, corrosive and/or toxic gases.
- Runoff from fire control or dilution water may cause environmental contamination.

FIRE OR EXPLOSION

- Some gases may burn or be ignited by heat, sparks or flames.
- May form explosive mixtures with air.
- Oxidizers may ignite combustibles (wood, paper, oil, clothing, etc.) but NOT readily due to low transportation pressures.
- Vapors may travel to source of ignition and flash back.
- Some of these materials may react violently with water.
- Cylinders exposed to fire may vent and release toxic and flammable gas through pressure relief devices.
- Runoff may create fire hazard.

PUBLIC SAFETY

- **CALL 911. Then call emergency response telephone number on shipping paper.** If shipping paper not available or no answer, refer to appropriate telephone number listed on the inside back cover.
- Keep unauthorized personnel away.
- Stay upwind, uphill and/or upstream.
- Many gases are heavier than air and will spread along the ground and collect in low or confined areas (sewers, basements, tanks, etc.).
- Ventilate closed spaces before entering, but only if properly trained and equipped.

PROTECTIVE CLOTHING

- Wear positive pressure self-contained breathing apparatus (SCBA).
- Wear chemical protective clothing that is specifically recommended by the manufacturer **when there is NO RISK OF FIRE.**
- Structural firefighters' protective clothing provides thermal protection **but only limited chemical protection.**

EVACUATION

Immediate precautionary measure

- Isolate spill or leak area for at least 100 meters (330 feet) in all directions.

Spill

- See [Table 1 - Initial Isolation and Protective Action Distances](#).

Fire

- If several small packages (inside a railcar or trailer) are involved in a fire, ISOLATE for 1600 meters (1 mile) in all directions; also, consider initial evacuation for 1600 meters (1 mile) in all directions.

* **SOME SUBSTANCES MAY ALSO BE FLAMMABLE, CORROSIVE AND/OR OXIDIZING**

EMERGENCY RESPONSE

FIRE

- **DO NOT EXTINGUISH A LEAKING GAS FIRE UNLESS LEAK CAN BE STOPPED.**

Small Fire

- Dry chemical, CO₂, water spray or alcohol-resistant foam.
- **For UN3515, UN3518, UN3520**, use water only; no dry chemical, CO₂ or Halon®.

Large Fire

- Water spray, fog or alcohol-resistant foam.
- Do not get water inside containers.
- If it can be done safely, move undamaged containers away from the area around the fire.
- Damaged cylinders should be handled only by specialists.

Fire Involving Several Small Packages (inside a railcar or trailer)

- Fight fire from maximum distance or use unmanned master stream devices or monitor nozzles.
- Cool containers with flooding quantities of water until well after fire is out.
- Do not direct water at source of leak or safety devices.
- Withdraw immediately in case of rising sound from venting safety devices or discoloration of tank.
- ALWAYS stay away from tanks in direct contact with flames.

SPILL OR LEAK

- Some gases may be flammable. ELIMINATE all ignition sources (no smoking, flares, sparks or flames) from immediate area.
- For flammable gases, all equipment used when handling the product must be grounded.
- For oxidizing substances, keep combustibles (wood, paper, oil, etc.) away from spilled material.
- Do not touch or walk through spilled material.
- Stop leak if you can do it without risk.
- Do not direct water at spill or source of leak.
- Use water spray to reduce vapors or divert vapor cloud drift. Avoid allowing water runoff to contact spilled material.
- Prevent entry into waterways, sewers, basements or confined areas.
- Isolate area until gas has dispersed.

FIRST AID

Refer to the "General First Aid" section.

Specific First Aid:

- In case of burns, immediately cool affected skin for as long as possible with cold water. Do not remove clothing if adhering to skin.



In Canada, an Emergency Response Assistance Plan (ERAP) may be required for this product. Please consult the shipping paper and/or the "ERAP" section.

GUIDE ADSORBED GASES - FLAMMABLE OR OXIDIZING

174

POTENTIAL HAZARDS

FIRE OR EXPLOSION

- Some gases will be ignited by heat, sparks or flames.
- Substance does not burn but will support combustion.
- Vapors may travel to source of ignition and flash back.
- Cylinders exposed to fire may vent and release flammable gas through pressure relief devices.
- Containers may explode when exposed to prolonged direct flame impingement.

HEALTH

- Vapors may cause dizziness or asphyxiation without warning, especially when in closed or confined areas.
- Some may be irritating if inhaled at high concentrations.
- Contact with gas may cause burns and injury.
- Fire may produce irritating and/or toxic gases.

PUBLIC SAFETY

- **CALL 911. Then call emergency response telephone number on shipping paper.** If shipping paper not available or no answer, refer to appropriate telephone number listed on the inside back cover.
- Keep unauthorized personnel away.
- Stay upwind, uphill and/or upstream.
- Many gases are heavier than air and will spread along the ground and collect in low or confined areas (sewers, basements, tanks, etc.).
- Ventilate closed spaces before entering, but only if properly trained and equipped.

PROTECTIVE CLOTHING

- Wear positive pressure self-contained breathing apparatus (SCBA).
- Structural firefighters' protective clothing provides thermal protection **but only limited chemical protection.**

EVACUATION

Immediate precautionary measure

- Isolate spill or leak area for at least 100 meters (330 feet) in all directions.

Large Spill

- Consider initial downwind evacuation for at least 800 meters (1/2 mile).

Fire

- If several small packages (inside a railcar or trailer) are involved in a fire, ISOLATE for 1600 meters (1 mile) in all directions; also, consider initial evacuation for 1600 meters (1 mile) in all directions.

EMERGENCY RESPONSE

FIRE

- **DO NOT EXTINGUISH A LEAKING GAS FIRE UNLESS LEAK CAN BE STOPPED.**

- Use extinguishing agent suitable for type of surrounding fire.

Small Fire

- Dry chemical or CO₂.

Large Fire

- Water spray or fog.
- If it can be done safely, move undamaged containers away from the area around the fire.
- Damaged cylinders should be handled only by specialists.

Fire Involving Several Small Packages (inside a railcar or trailer)

- Fight fire from maximum distance or use unmanned master stream devices or monitor nozzles.
- Cool containers with flooding quantities of water until well after fire is out.
- Do not direct water at source of leak or safety devices.
- Withdraw immediately in case of rising sound from venting safety devices or discoloration of tank.
- ALWAYS stay away from tanks in direct contact with flames.
- For massive fire, use unmanned master stream devices or monitor nozzles; if this is impossible, withdraw from area and let fire burn.

SPILL OR LEAK

- For flammable gases, ELIMINATE all ignition sources (no smoking, flares, sparks or flames) from immediate area.
- For oxidizing substances, keep combustibles (wood, paper, oil, etc.) away from spilled material.
- All equipment used when handling the product must be grounded.
- Do not touch or walk through spilled material.
- Stop leak if you can do it without risk.
- Use water spray to reduce vapors or divert vapor cloud drift. Avoid allowing water runoff to contact spilled material.
- Do not direct water at spill or source of leak.
- Prevent spreading of vapors through sewers, ventilation systems and confined areas.
- Ventilate the area.
- Isolate area until gas has dispersed.

FIRST AID

Refer to the "General First Aid" section.

Specific First Aid:

- In case of burns, immediately cool affected skin for as long as possible with cold water. Do not remove clothing if adhering to skin.



In Canada, an Emergency Response Assistance Plan (ERAP) may be required for this product. Please consult the shipping paper and/or the "ERAP" section.

INTRODUCTION TO GREEN TABLES

TABLE 1 - INITIAL ISOLATION AND PROTECTIVE ACTION DISTANCES

This table suggests distances useful to protect people from vapors/gases resulting from spills involving:

- materials that are considered toxic by inhalation (TIH) (PIH in the US)
- materials which produce toxic gases upon contact with water

This table provides first responders with initial guidance until technically qualified emergency response personnel are available. For each material, first responders will find distances for the following zones:

- The **Initial Isolation Zone** defines an area **surrounding** the incident in which people may be exposed to dangerous (upwind) and life-threatening (downwind) concentrations of material.
- The **Protective Action Zone** defines an area **downwind** from the incident in which people may become incapacitated and unable to take protective action and/or incur serious or irreversible health effects. Table 1 provides specific guidance for small and large spills occurring day or night.

Adjusting distances for a specific incident involves many interdependent variables. These adjustments should only be made by technically qualified personnel. For this reason, no precise guidance can be provided in this document to aid in adjusting the table distances; however, general guidance follows.

Factors that May Change the Protective Action Distances

Fire

In the **orange section**, under **EVACUATION – Fire**, the evacuation distance required to protect against fragmentation hazard of a large container is clearly indicated. If involved in a fire, the toxic hazard may be less dangerous than the fire or explosion hazard.

In these cases, the **fire hazard distance should be used** as an isolation distance and Table 1 should be used to protect downwind for residual material release.

Worst-case scenario: terrorism, sabotage or catastrophic accident

Initial isolation and protective action distances are derived from historical data on transportation incidents and the use of statistical models. For worst-case scenarios involving the instantaneous release of the entire contents of a package (e.g., as a result of terrorism, sabotage or catastrophic accident), the distances may increase substantially.

For such events, **doubling** the initial isolation and protective action distances is appropriate in absence of other information.

When more than one large package is leaking

If more than one rail tank car, highway tank, tank or large cylinder, containing TIH materials is leaking, **large spill** distances may need to be increased.

Other factors that can increase the protective action distance:

- If a material has a **protective action distance of 11.0+ km (7.0+ miles)**, the actual distance can be larger in certain atmospheric conditions.
- If the material's vapor plume is **channeled in a valley** or **between many tall buildings**, protective action distances may be larger than shown due to less mixing of the plume with the atmosphere.
- If there is a **daytime spill** in a region with known **strong temperature inversions** or **snow cover**, or it occurs **near sunset**, this may require an increase of the protective action distance because airborne contaminants mix and disperse more slowly and may travel much farther downwind.
 - › In such cases, the nighttime protective action distances may be more appropriate.
- If the temperature of the **liquid spill** or the **outdoor temperature exceeds 30°C (86°F)**, the protective action distance may be larger.

Water-reactive materials

Materials that react with water to produce large amounts of toxic gases are included in Table 1. Some of these materials have 2 entries in Table 1. They are identified by **(when spilled on land)** since they are TIH products and **(when spilled in water)** because they produce additional toxic gases when spilled in water.

Choose the **larger protective action distance** if:

- it is not clear whether the spill is on land or in water
- the spill occurs both on land and in water

TABLE 2 - WATER-REACTIVE MATERIALS WHICH PRODUCE TOXIC GASES

This table lists materials which produce large amounts of Toxic Inhalation Hazard gases (TIH) when spilled in water as well as the TIH gases that are produced.

NOTE: The produced TIH gases indicated in Table 2 are for information purposes only. In Table 1, the initial isolation and protective action distances have already taken into consideration the produced TIH gas.

When a water-reactive TIH-producing material is spilled into a river or stream, the source of the toxic gas may flow downstream for a great distance.

TABLE 3 - INITIAL ISOLATION AND PROTECTIVE ACTION DISTANCES FOR LARGE SPILLS FOR DIFFERENT QUANTITIES OF SIX COMMON TIH (PIH IN THE US) GASES

This table lists materials that may be more commonly encountered. These materials are:

- UN1005 - Ammonia, anhydrous
- UN1017 - Chlorine
- UN1040 - Ethylene oxide and UN1040 - Ethylene oxide with nitrogen
- UN1050 - Hydrogen chloride, anhydrous and UN2186 - Hydrogen chloride, refrigerated liquid
- UN1052 - Hydrogen fluoride, anhydrous
- UN1079 - Sulfur dioxide/Sulphur dioxide

This table provides initial isolation and protective action distances for large spills (more than 208 liters or 55 US gallons):

- involving different container types (therefore different volume capacities)
- for daytime and nighttime situations
- for different wind speeds (low, moderate and high)

PROTECTIVE ACTIONS

Protective actions are the steps taken to preserve the health and safety of emergency responders and the public during an incident involving releases of hazardous materials/dangerous goods.

Table 1 - Initial Isolation and Protective Action Distances (green section) predicts the size of the area that could be affected by a cloud of toxic gas. People in this area should be evacuated and/or sheltered-in-place inside buildings.

Isolate hazard area and deny entry means to keep everybody away from the area if they are not directly involved in emergency response operations. Unprotected emergency responders should not be allowed to enter the isolation zone.

This "isolation" task is done to establish control over the area of operations. This is the first step for any protective actions that may follow.

Evacuate means to move all people from a threatened area to a safer place. To perform an evacuation, there must be enough time for people to be warned, get ready, and leave an area. If there is enough time, evacuation is the best protective action.

Begin evacuating people nearby and those who are outdoors in direct view of the scene. When additional help arrives, expand the area to be evacuated downwind and crosswind to at least the extent recommended in this guidebook.

Even after people move to the distances recommended, they may not be completely safe from harm. They should not be permitted to gather at such distances. Send evacuees to a definite place, by a specific route, far enough away so they will not have to relocate again if the wind shifts.

Shelter-in-place means people should seek shelter inside a building and remain inside until the danger passes. **It is vital for first responders to maintain communications with sheltered-in-place people** so that they are advised about changing conditions.

Sheltering-in-place is used either when:

- evacuating the public would cause greater risk than staying where they are
- an evacuation cannot be safely performed

Direct the people inside to:

- close all doors and windows
- shut off all ventilating, heating and cooling systems
- stay far from windows to avoid shattered glass and projectile metal fragments in the event of a fire and/or explosion
- seal cracks around doors, windows and vents with duct tape or wet cloths
- tune in to local media, and remain inside until told it is safe to leave by first responders or emergency response authorities
- breathe through a wet cloth until an all clear has been communicated

Vehicles can offer some protection for a short period if the windows are closed and the ventilation systems are shut off. Vehicles are not nearly as effective as buildings for in-place protection.

PROTECTIVE ACTION DECISION FACTORS TO CONSIDER

The choice of protective actions for a given situation depends on a number of factors. For some cases, evacuation may be the best option; in others, sheltering-in-place may be the best course. Sometimes, these two actions may be used in combination. In any emergency, officials need to quickly give the public instructions. The public will need continuing information and instructions while being evacuated or sheltered-in-place.

Proper evaluation of the factors listed below will determine the effectiveness of evacuation or in-place protection (shelter-in-place). The importance of these factors can vary with emergency conditions. In specific emergencies, other factors may need to be identified and considered as well. This list indicates what kind of information may be needed to make the initial decision.

The hazardous materials/dangerous goods:

- degree of health hazard
- chemical and physical properties
- amount involved
- containment/control of release
- rate of vapor movement

The population threatened:

- location
- number of people
- time available to evacuate or shelter-in-place
- ability to control evacuation or shelter-in-place
- building types and availability
- special institutions or populations, e.g., nursing homes, hospitals, prisons

The weather conditions:

- effect on vapor and cloud movement
- potential for change
- effect on evacuation or shelter-in-place

NOTE: Every hazardous materials/dangerous goods incident is different. Each will have special problems and concerns. Actions to protect the public must be carefully selected. This section can help with **initial** decisions on how to protect the public. Officials must continue to gather information and monitor the situation until the threat is removed.

The following table can help to decide if evacuation or sheltering-in-place is the best option:

Consider Evacuation:	Consider Sheltering-in-place:
Vapors are flammable.	Vapors are toxic, and people are likely to be exposed by evacuating.
Buildings cannot be closed tightly.	Buildings can be quickly sealed by closing all windows and ventilation systems, if applicable.
The vapors are continuously generated and will hug the ground, or it will take a long time for the vapors to clear the area.	The vapors will quickly rise in the air column or rapidly dissipate.
For anyone outdoors.	For anyone already indoors.
There are few people to evacuate.	There are too many people to evacuate for current available resources.
The threat seems stable but long-lasting.	Circumstances are changing too quickly to evacuate safely.

BACKGROUND ON TABLE 1 – INITIAL ISOLATION AND PROTECTIVE ACTION DISTANCES

Initial isolation and protective action distances in this guidebook were determined for small and large spills occurring during day or night. The overall analysis, statistical in nature, was conducted using:

- state-of-the-art emission rate and dispersion models
- statistical release data from the U.S. Department of Transportation (DOT) Hazardous Materials Information System (HMIS) database
- meteorological observations from more than 120 locations in the United States, Canada, and Mexico
- the most current toxicological exposure guidelines

For each chemical, thousands of hypothetical releases were modeled to account for the statistical variance in both release amount and atmospheric conditions. Based on this statistical sample, they selected the 90th percentile protective action distance for each chemical and category to appear in the table. A brief description of the analysis is provided below.

A detailed report outlining the methodology and data used to generate the initial isolation and protective action distances may be obtained from the U.S. DOT, Pipeline and Hazardous Materials Safety Administration (PHMSA).

DESCRIPTION OF THE ANALYSIS

Release amounts and emission rates into the atmosphere were statistically modeled based on:

- data from the U.S. DOT HMIS database
- container types and sizes authorized for transport as specified in 49 CFR §172.101 and Part 173
- physical properties of the individual materials
- atmospheric data from a historical database

For liquefied gases, which can flash to form both a vapor/aerosol mixture and an evaporating pool, the emission model calculated one or both of:

- the release of vapor due to evaporation of pools on the ground
- direct release of vapors from the container

The emission model also calculated the emission of toxic vapor by-products generated from spilling water-reactive materials in water.

Small spills involve 208 liters (55 US gallons) or less.

Large spills involve greater quantities.

Downwind dispersion of the vapor was estimated for each case modeled. Using a database containing hourly meteorological data from 120 American, Canadian, and Mexican cities, the atmospheric parameters affecting the dispersion and the emission rate were selected.

The dispersion calculation accounted for both the:

- time-dependent emission rate from the source
- density of the vapor plume (i.e., heavy gas effects)

Since atmospheric mixing is less effective at dispersing vapor plumes during nighttime, day and night were separated in the analysis.

In the table:

- **day** refers to time periods after sunrise and before sunset
- **night** includes all hours between sunset and sunrise

Toxicological short-term exposure guidelines for the materials were applied to determine the downwind distance to which people may:

- become incapacitated and unable to take protective action
- incur serious health effects after a single, or rare, exposure

When available, toxicological exposure guidelines were chosen from AEGL-2 or ERPG-2 emergency response guidelines. AEGL-2 values were the first choice.

For materials without AEGL-2 or ERPG-2 values, emergency response guidelines were estimated based on lethal concentration limits derived from animal-based-studies. This approach was recommended by an independent panel of toxicological experts from industry and academia.

HOW TO USE TABLE 1 – INITIAL ISOLATION AND PROTECTIVE ACTION DISTANCES

- (1) The responder should already have:
 - identified the material by its ID number and name (if you cannot find an ID number, use the Name of Material index in the blue section to find that number);
 - confirmed that the material is highlighted in green in the yellow or blue section. If not, Table 1 doesn't apply;
 - found the three-digit guide for the material, in order to consult emergency actions it recommends along with this table; and
 - **noted the wind direction**
- (2) Look in Table 1 (green section) for the ID number and name of the material involved. Some ID numbers have more than one shipping name listed. Look for the specific name of the material. If you do not know the shipping name and Table 1 lists more than one name for the same ID number, use the entry with the largest distances.
- (3) Determine if the incident involves a SMALL or LARGE spill and if it is DAY or NIGHT. A SMALL SPILL consists of a release of 208 liters (55 US gallons) or less. This generally corresponds to a spill from a single small package (for example, a drum), a small cylinder, or a small leak from a large package. A LARGE SPILL consists of a release of more than 208 liters (55 US gallons). This usually involves a spill from a large package, or multiple spills from many small packages. DAY is any time after sunrise and before sunset. NIGHT is any time between sunset and sunrise.

- (4) Look up the INITIAL ISOLATION DISTANCE. This distance defines the radius of a zone (initial isolation zone) surrounding the spill in ALL DIRECTIONS. In this zone, protective clothing and respiratory protection is required. Evacuate the general public in a direction perpendicular to wind direction (crosswind) and away from the spill.

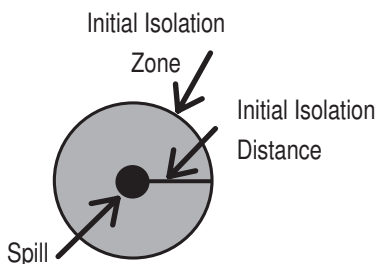

- (5) Look up the PROTECTIVE ACTION DISTANCE. For a given material, spill size, and whether day or night, Table 1 gives the downwind distance—in kilometers and miles—from the spill or leak source, for which you should consider protective actions. For practical purposes, the protective action zone (i.e., the area in which people are at risk of harmful exposure) is a square. Its length and width are the same as the downwind distance shown in Table 1. Protective actions are the steps you take to preserve the health and safety of emergency responders and

the public. **People in this area should be evacuated and/or sheltered-in-place.** For more information, consult the “Protective Actions” section.

- (6) Initiate protective actions beginning with those closest to the spill site and working away in a downwind direction. When a water-reactive TIH (PIH in the US) producing material is spilled into a river or stream, the source of the toxic gas may move with the current or stretch from the spill point downstream for a large distance.

In the figure below, the spill is located at the center of the small black circle. The larger circle represents the initial isolation zone around the spill. The square (the protective action zone) is the area in which you should take protective actions.

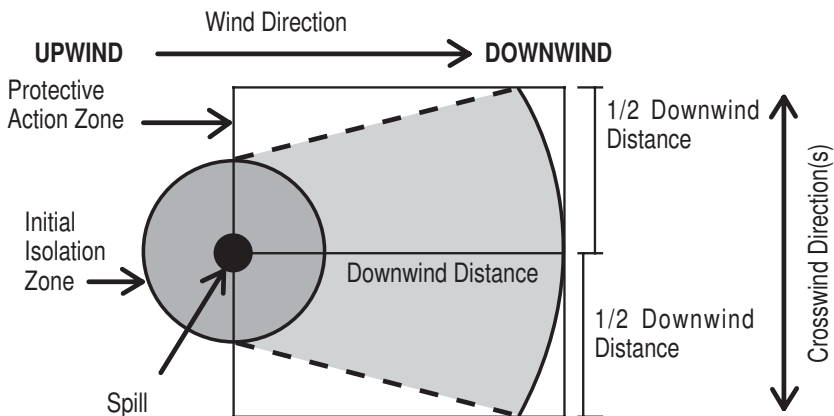

Note 1: For factors that may change the protective action distances, see the "Introduction to Green Tables" section.

Note 2: When a product in Table 1 has the mention (when spilled in water), you can refer to Table 2 for the list of gases produced when these materials are spilled in water. The TIH gases indicated in Table 2 are for information purposes only.

Note 3: For the instantaneous release of the entire contents of a package (e.g., as a result of terrorism, sabotage or catastrophic failure), the distances should be doubled.

For more information on the material, safety precautions and mitigation procedures, call the emergency response telephone number listed on the shipping paper or the appropriate response agency as soon as possible.

TABLE 1 - INITIAL ISOLATION AND PROTECTIVE ACTION DISTANCES

		SMALL SPILLS (From a small package or small leak from a large package)		LARGE SPILLS (From a large package or from many small packages)		
ID No.	Guide No.	Name of Material	First ISOLATE	Then PROTECT	First ISOLATE	Then PROTECT
			in all Directions Meters (Feet)	persons Downwind during DAY (Miles) NIGHT (Miles)	in all Directions Meters (Feet)	persons Downwind during DAY (Miles) NIGHT (Miles)
1005	125	Ammonia, anhydrous	30 m (100 ft)	0.1 km (0.1 mi) 0.2 km (0.1 mi)	Refer to Table 3	
1005	125	Anhydrous ammonia				
1008	125	Boron trifluoride	30 m (100 ft)	0.2 km (0.1 mi) 0.7 km (0.5 mi)	400 m (1250 ft)	2.4 km (1.5 mi) 4.7 km (2.9 mi)
1008	125	Boron trifluoride, compressed				
1016	119	Carbon monoxide, compressed	30 m (100 ft)	0.1 km (0.1 mi) 0.2 km (0.1 mi)	200 m (600 ft)	1.2 km (0.7 mi) 3.9 km (2.4 mi)
1017	124	Chlorine	60 m (200 ft)	0.3 km (0.2 mi) 1.5 km (0.9 mi)	Refer to Table 3	
1026	119	Cyanogen	30 m (100 ft)	0.1 km (0.1 mi) 0.4 km (0.3 mi)		
1040	119P	Ethylene oxide	30 m (100 ft)	0.1 km (0.1 mi) 0.2 km (0.2 mi)	Refer to Table 3	
1040	119P	Ethylene oxide with nitrogen				
1045	124	Fluorine, compressed	30 m (100 ft)	0.1 km (0.1 mi) 0.2 km (0.1 mi)	100 m (300 ft)	0.5 km (0.3 mi) 2.3 km (1.4 mi)
1048	125	Hydrogen bromide, anhydrous	30 m (100 ft)	0.1 km (0.1 mi) 0.2 km (0.2 mi)	150 m (500 ft)	1.0 km (0.7 mi) 3.2 km (2.0 mi)
1050	125	Hydrogen chloride, anhydrous	30 m (100 ft)	0.1 km (0.1 mi) 0.3 km (0.2 mi)	Refer to Table 3	
1051	117P	Hydrogen cyanide, stabilized	60 m (200 ft)	0.2 km (0.1 mi) 0.7 km (0.4 mi)		
1052	125	Hydrogen fluoride, anhydrous	30 m (100 ft)	0.1 km (0.1 mi) 0.5 km (0.3 mi)	200 m (600 ft)	0.7 km (0.5 mi) 1.8 km (1.1 mi)
1053	117	Hydrogen sulfide	30 m (100 ft)	0.1 km (0.1 mi) 0.5 km (0.3 mi)	Refer to Table 3	
1053	117	Hydrogen sulphide				
1061	118	Methylamine, anhydrous	30 m (100 ft)	0.1 km (0.1 mi) 0.2 km (0.1 mi)	400 m (1250 ft)	2.4 km (1.5 mi) 6.3 km (4.0 mi)
1062	123	Methyl bromide	30 m (100 ft)	0.1 km (0.1 mi) 0.2 km (0.1 mi)	200 m (600 ft)	0.6 km (0.4 mi) 2.1 km (1.3 mi)
1064	117	Methyl mercaptan	30 m (100 ft)	0.1 km (0.1 mi) 0.1 km (0.1 mi)	150 m (500 ft)	0.3 km (0.2 mi) 0.7 km (0.5 mi)
1067	124	Dinitrogen tetroxide	30 m (100 ft)	0.1 km (0.1 mi) 0.3 km (0.2 mi)	200 m (600 ft)	1.3 km (0.8 mi) 3.9 km (2.4 mi)
1067	124	Nitrogen dioxide	30 m (100 ft)	0.1 km (0.1 mi) 0.4 km (0.3 mi)	400 m (1250 ft)	1.4 km (0.9 mi) 3.3 km (2.1 mi)

1069	125	Nitrosyl chloride	30 m (100 ft)	0.2 km (0.2 mi)	1.0 km (0.7 mi)	800 m (2500 ft)	4.3 km (2.7 mi)	9.6 km (6.0 mi)
1076	125	Phosgene	100 m (300 ft)	0.6 km (0.4 mi)	2.5 km (1.6 mi)	500 m (1500 ft)	3.0 km (1.9 mi)	9.5 km (5.9 mi)
1079	125	Sulfur dioxide	100 m (300 ft)	0.6 km (0.4 mi)	2.6 km (1.6 mi)		Refer to Table 3	
1079	125	Sulphur dioxide						
1082	119P	Refrigerant gas R-1113	30 m (100 ft)	0.1 km (0.1 mi)	0.1 km (0.1 mi)	60 m (200 ft)	0.4 km (0.3 mi)	0.7 km (0.5 mi)
1082	119P	Trifluorochloroethylene, stabilized						
1092	131P	Acrolein, stabilized	100 m (300 ft)	1.3 km (0.8 mi)	3.5 km (2.2 mi)	600 m (2000 ft)	6.8 km (4.2 mi)	11.1 km (6.9 mi)
1093	131P	Acrylonitrile, stabilized	30 m (100 ft)	0.2 km (0.2 mi)	0.6 km (0.4 mi)	100 m (300 ft)	1.3 km (0.8 mi)	2.3 km (1.5 mi)
1098	131	Allyl alcohol	30 m (100 ft)	0.2 km (0.1 mi)	0.3 km (0.2 mi)	60 m (200 ft)	0.8 km (0.5 mi)	1.2 km (0.8 mi)
1135	131	Ethylene chlorohydrin	30 m (100 ft)	0.1 km (0.1 mi)	0.1 km (0.1 mi)	30 m (100 ft)	0.1 km (0.1 mi)	0.1 km (0.1 mi)
1143	131P	Crotonaldehyde	30 m (100 ft)	0.1 km (0.1 mi)	0.2 km (0.1 mi)	60 m (200 ft)	0.5 km (0.3 mi)	0.7 km (0.5 mi)
1143	131P	Crotonaldehyde, stabilized						
1162	155	Dimethyldichlorosilane (when spilled in water)	30 m (100 ft)	0.1 km (0.1 mi)	0.1 km (0.1 mi)	30 m (100 ft)	0.4 km (0.2 mi)	1.2 km (0.8 mi)
1163	131	Dimethylhydrazine, unsymmetrical	30 m (100 ft)	0.2 km (0.1 mi)	0.5 km (0.3 mi)	100 m (300 ft)	1.0 km (0.7 mi)	1.8 km (1.1 mi)
1182	155	Ethyl chloroformate	30 m (100 ft)	0.2 km (0.1 mi)	0.3 km (0.2 mi)	60 m (200 ft)	0.6 km (0.4 mi)	0.9 km (0.6 mi)
1183	139	Ethyldichlorosilane (when spilled in water)	30 m (100 ft)	0.1 km (0.1 mi)	0.1 km (0.1 mi)	60 m (200 ft)	0.5 km (0.3 mi)	1.5 km (0.9 mi)
1185	131P	Ethylenimine, stabilized	30 m (100 ft)	0.2 km (0.1 mi)	0.5 km (0.3 mi)	200 m (600 ft)	1.0 km (0.6 mi)	1.8 km (1.1 mi)
1196	155	Ethyltrichlorosilane (when spilled in water)	30 m (100 ft)	0.1 km (0.1 mi)	0.5 km (0.3 mi)	150 m (500 ft)	1.8 km (1.2 mi)	3.7 km (2.3 mi)
1238	155	Methyl chloroformate	30 m (100 ft)	0.2 km (0.2 mi)	0.5 km (0.4 mi)	150 m (500 ft)	1.2 km (0.7 mi)	2.2 km (1.4 mi)
1239	131	Methyl chloromethyl ether	60 m (200 ft)	0.5 km (0.3 mi)	1.5 km (1.0 mi)	300 m (1000 ft)	3.4 km (2.1 mi)	5.7 km (3.6 mi)

"+" means distance can be larger in certain atmospheric conditions

TABLE 1

TABLE 1 - INITIAL ISOLATION AND PROTECTIVE ACTION DISTANCES

		SMALL SPILLS (From a small package or small leak from a large package)				LARGE SPILLS (From a large package or from many small packages)				
ID No.	Guide No.	Name of Material	First ISOLATE in all Directions		Then PROTECT persons Downwind during		First ISOLATE in all Directions		Then PROTECT persons Downwind during	
			Meters (Feet)	(Miles)	DAY Kilometers (Miles)	NIGHT Kilometers (Miles)	Meters (Feet)	(Feet)	DAY Kilometers (Miles)	NIGHT Kilometers (Miles)
1242	139	Methyldichlorosilane (when spilled in water)	30 m (100 ft)	0.1 km (0.1 mi)	0.1 km (0.1 mi)	0.1 km (0.1 mi)	60 m (200 ft)	0.5 km (0.4 mi)	1.7 km (1.1 mi)	
1244	131	Methylhydrazine	30 m (100 ft)	0.3 km (0.2 mi)	0.6 km (0.4 mi)		150 m (500 ft)	1.5 km (0.9 mi)	2.2 km (1.4 mi)	
1250	155	Methyltrichlorosilane (when spilled in water)	30 m (100 ft)	0.1 km (0.1 mi)	0.1 km (0.1 mi)		60 m (200 ft)	0.6 km (0.4 mi)	1.9 km (1.2 mi)	
1251	131P	Methyl vinyl ketone, stabilized	100 m (300 ft)	0.3 km (0.2 mi)	0.7 km (0.5 mi)		800 m (2500 ft)	1.7 km (1.1 mi)	2.8 km (1.8 mi)	
1259	131	Nickel carbonyl	100 m (300 ft)	1.4 km (0.9 mi)	5.2 km (3.3 mi)		1000 m (3000 ft)	11.0+ km (7.0+ mi)	11.0+ km (7.0+ mi)	
1295	139	Trichlorosilane (when spilled in water)	30 m (100 ft)	0.1 km (0.1 mi)	0.1 km (0.1 mi)		60 m (200 ft)	0.5 km (0.3 mi)	1.5 km (0.9 mi)	
1298	155	Trimethylchlorosilane (when spilled in water)	30 m (100 ft)	0.1 km (0.1 mi)	0.1 km (0.1 mi)		30 m (100 ft)	0.4 km (0.2 mi)	1.0 km (0.6 mi)	
1305	155P	Vinyltrichlorosilane (when spilled in water)	30 m (100 ft)	0.1 km (0.1 mi)	0.1 km (0.1 mi)		30 m (100 ft)	0.4 km (0.3 mi)	1.3 km (0.8 mi)	
1340	139	Phosphorus pentasulfide, free from yellow and white phosphorus								
1340	139	Phosphorus pentasulphide, free from yellow and white phosphorus (when spilled in water)	30 m (100 ft)	0.1 km (0.1 mi)	0.1 km (0.1 mi)		30 m (100 ft)	0.2 km (0.2 mi)	1.0 km (0.6 mi)	
1360	139	Calcium phosphide (when spilled in water)	30 m (100 ft)	0.1 km (0.1 mi)	0.4 km (0.3 mi)		200 m (600 ft)	0.8 km (0.5 mi)	2.7 km (1.7 mi)	

1380	135	Pentaborane	60 m (200 ft)	0.6 km (0.4 mi)	2.0 km (1.3 mi)	300 m (1000 ft)	3.0 km (1.9 mi)	6.5 km (4.1 mi)
1384	135	Sodium dithionite (when spilled in water)						
1384	135	Sodium hydrosulfite (when spilled in water)	30 m (100 ft)	0.1 km (0.1 mi)	0.4 km (0.3 mi)	60 m (200 ft)	0.5 km (0.3 mi)	2.1 km (1.3 mi)
1384	135	Sodium hydrosulphite (when spilled in water)						
1390	139	Alkali metal amides (when spilled in water)	30 m (100 ft)	0.1 km (0.1 mi)	0.3 km (0.2 mi)	60 m (200 ft)	0.5 km (0.3 mi)	1.8 km (1.1 mi)
1397	139	Aluminum phosphide (when spilled in water)	30 m (100 ft)	0.1 km (0.1 mi)	0.7 km (0.4 mi)	400 m (1250 ft)	1.6 km (1.0 mi)	4.7 km (2.9 mi)
1419	139	Magnesium aluminum phosphide (when spilled in water)	30 m (100 ft)	0.1 km (0.1 mi)	0.6 km (0.4 mi)	400 m (1250 ft)	1.4 km (0.9 mi)	4.1 km (2.6 mi)
1432	139	Sodium phosphide (when spilled in water)	30 m (100 ft)	0.1 km (0.1 mi)	0.4 km (0.2 mi)	300 m (1000 ft)	1.0 km (0.6 mi)	3.0 km (1.9 mi)
1510	143	Tetranitromethane	30 m (100 ft)	0.2 km (0.1 mi)	0.3 km (0.2 mi)	30 m (100 ft)	0.4 km (0.3 mi)	0.7 km (0.4 mi)
1541	156	Acetone cyanohydrin, stabilized (when spilled in water)	30 m (100 ft)	0.1 km (0.1 mi)	0.1 km (0.1 mi)	60 m (200 ft)	0.2 km (0.1 mi)	0.5 km (0.3 mi)
1556	152	Methyldichloroarsine	150 m (500 ft)	1.4 km (0.9 mi)	2.2 km (1.4 mi)	300 m (1000 ft)	4.0 km (2.5 mi)	5.8 km (3.6 mi)
1560	157	Arsenic chloride						
1560	157	Arsenic trichloride	30 m (100 ft)	0.2 km (0.1 mi)	0.3 km (0.2 mi)	100 m (300 ft)	1.0 km (0.7 mi)	1.5 km (1.0 mi)
1569	131	Bromoacetone	30 m (100 ft)	0.4 km (0.3 mi)	1.2 km (0.8 mi)	150 m (500 ft)	1.8 km (1.1 mi)	3.3 km (2.1 mi)
1580	154	Chloropicrin	60 m (200 ft)	0.5 km (0.4 mi)	1.2 km (0.8 mi)	200 m (600 ft)	2.4 km (1.5 mi)	3.7 km (2.3 mi)
1581	123	Chloropicrin and methyl bromide mixture	30 m (100 ft)	0.1 km (0.1 mi)	0.6 km (0.4 mi)	300 m (1000 ft)	2.1 km (1.3 mi)	5.9 km (3.7 mi)
1582	119	Chloropicrin and methyl chloride mixture	30 m (100 ft)	0.1 km (0.1 mi)	0.5 km (0.3 mi)	60 m (200 ft)	0.5 km (0.3 mi)	2.1 km (1.3 mi)

"+" means distance can be larger in certain atmospheric conditions

TABLE 1

TABLE 1 - INITIAL ISOLATION AND PROTECTIVE ACTION DISTANCES

		SMALL SPILLS (From a small package or small leak from a large package)				LARGE SPILLS (From a large package or from many small packages)				
ID No.	Guide No.	Name of Material	First ISOLATE in all Directions		Then PROTECT persons Downwind during		First ISOLATE in all Directions		Then PROTECT persons Downwind during	
			Meters (Feet)	(Kilometers (Miles))	DAY (Kilometers (Miles))	NIGHT (Kilometers (Miles))	Meters (Feet)	(Kilometers (Miles))	DAY (Kilometers (Miles))	NIGHT (Kilometers (Miles))
1583	154	Chloropicrin mixture, n.o.s.	30 m (100 ft)	0.1 km (0.1 mi)	0.6 km (0.4 mi)	300 m (1000 ft)	2.1 km (1.3 mi)	5.9 km (3.7 mi)		
1589	125	Cyanogen chloride, stabilized	300 m (1000 ft)	1.9 km (1.2 mi)	6.6 km (4.1 mi)	1000 m (3000 ft)	11.0+ km (7.0+ mi)	11.0+ km (7.0+ mi)		
1595	156	Dimethyl sulfate	30 m (100 ft)	0.1 km (0.1 mi)	0.1 km (0.1 mi)	60 m (200 ft)	0.2 km (0.1 mi)	0.7 km (0.4 mi)		
1595	156	Dimethyl sulphate	30 m (100 ft)	0.1 km (0.1 mi)	0.1 km (0.1 mi)	60 m (200 ft)	0.2 km (0.1 mi)	0.7 km (0.4 mi)		
1605	154	Ethylene dibromide	30 m (100 ft)	0.1 km (0.1 mi)	0.1 km (0.1 mi)	30 m (100 ft)	0.1 km (0.1 mi)	0.2 km (0.1 mi)		
1612	123	Hexaethyl tetraphosphate and compressed gas mixture	100 m (300 ft)	0.8 km (0.5 mi)	2.7 km (1.7 mi)	400 m (1250 ft)	3.5 km (2.2 mi)	8.1 km (5.1 mi)		
1613	154	Hydrocyanic acid, aqueous solution, with not more than 20% hydrogen cyanide								
1613	154	Hydrogen cyanide, aqueous solution, with not more than 20% hydrogen cyanide	30 m (100 ft)	0.1 km (0.1 mi)	0.1 km (0.1 mi)	100 m (300 ft)	0.5 km (0.3 mi)	1.1 km (0.7 mi)		
1614	152	Hydrogen cyanide, stabilized (absorbed)	60 m (200 ft)	0.2 km (0.1 mi)	0.6 km (0.4 mi)	150 m (500 ft)	0.5 km (0.3 mi)	1.5 km (1.0 mi)		
1647	151	Methyl bromide and ethylene dibromide mixture, liquid	30 m (100 ft)	0.1 km (0.1 mi)	0.1 km (0.1 mi)	150 m (500 ft)	0.3 km (0.2 mi)	0.7 km (0.5 mi)		
1660	124	Nitric oxide, compressed	30 m (100 ft)	0.1 km (0.1 mi)	0.6 km (0.4 mi)	100 m (300 ft)	0.6 km (0.4 mi)	2.2 km (1.4 mi)		
1670	157	Perchloromethyl mercaptan	30 m (100 ft)	0.3 km (0.2 mi)	0.4 km (0.2 mi)	100 m (300 ft)	0.8 km (0.5 mi)	1.3 km (0.8 mi)		
1672	151	Phenylcarbamylamine chloride	30 m (100 ft)	0.2 km (0.1 mi)	0.2 km (0.1 mi)	60 m (200 ft)	0.5 km (0.3 mi)	0.7 km (0.4 mi)		
1680	157	Potassium cyanide, solid (when spilled in water)	30 m (100 ft)	0.1 km (0.1 mi)	0.1 km (0.1 mi)	60 m (200 ft)	0.2 km (0.1 mi)	0.7 km (0.4 mi)		

1689	157	Sodium cyanide, solid (when spilled in water)	30 m (100 ft)	0.1 km (0.1 mi)	0.1 km (0.1 mi)	60 m (200 ft)	0.2 km (0.2 mi)	0.9 km (0.6 mi)
1695	131	Chloroacetone, stabilized	30 m (100 ft)	0.1 km (0.1 mi)	0.2 km (0.1 mi)	60 m (200 ft)	0.4 km (0.3 mi)	0.6 km (0.4 mi)
1716	156	Acetyl bromide (when spilled in water)	30 m (100 ft)	0.1 km (0.1 mi)	0.1 km (0.1 mi)	30 m (100 ft)	0.2 km (0.2 mi)	0.7 km (0.4 mi)
1717	155	Acetyl chloride (when spilled in water)	30 m (100 ft)	0.1 km (0.1 mi)	0.1 km (0.1 mi)	60 m (200 ft)	0.7 km (0.4 mi)	2.0 km (1.2 mi)
1722	155	Allyl chloroacetate	100 m (300 ft)	0.3 km (0.2 mi)	0.8 km (0.5 mi)	400 m (1250 ft)	1.5 km (0.9 mi)	2.4 km (1.5 mi)
1724	155	Allyltrichlorosilane, stabilized (when spilled in water)	30 m (100 ft)	0.1 km (0.1 mi)	0.1 km (0.1 mi)	30 m (100 ft)	0.4 km (0.2 mi)	1.2 km (0.8 mi)
1725	137	Aluminum bromide, anhydrous (when spilled in water)	30 m (100 ft)	0.1 km (0.1 mi)	0.1 km (0.1 mi)	30 m (100 ft)	0.1 km (0.1 mi)	0.2 km (0.1 mi)
1726	137	Aluminum chloride, anhydrous (when spilled in water)	30 m (100 ft)	0.1 km (0.1 mi)	0.1 km (0.1 mi)	30 m (100 ft)	0.4 km (0.2 mi)	1.5 km (1.0 mi)
1728	156	Amyltrichlorosilane (when spilled in water)	30 m (100 ft)	0.1 km (0.1 mi)	0.1 km (0.1 mi)	30 m (100 ft)	0.4 km (0.2 mi)	1.2 km (0.7 mi)
1732	157	Antimony pentafluoride (when spilled in water)	30 m (100 ft)	0.1 km (0.1 mi)	0.3 km (0.2 mi)	100 m (300 ft)	0.8 km (0.5 mi)	3.0 km (1.9 mi)
1741	125	Boron trichloride (when spilled on land)	30 m (100 ft)	0.1 km (0.1 mi)	0.3 km (0.2 mi)	100 m (300 ft)	0.6 km (0.4 mi)	1.3 km (0.8 mi)
1741	125	Boron trichloride (when spilled in water)	30 m (100 ft)	0.1 km (0.1 mi)	0.2 km (0.2 mi)	100 m (300 ft)	0.9 km (0.6 mi)	2.8 km (1.7 mi)
1744	154	Bromine						
1744	154	Bromine, solution	60 m (200 ft)	0.8 km (0.5 mi)	2.4 km (1.5 mi)	400 m (1250 ft)	4.2 km (2.6 mi)	7.6 km (4.7 mi)
1744	154	Bromine, solution (Inhalation Hazard Zone A)						

"+" means distance can be larger in certain atmospheric conditions

TABLE 1

TABLE 1 - INITIAL ISOLATION AND PROTECTIVE ACTION DISTANCES

ID No.	Guide No.	Name of Material	SMALL SPILLS (From a small package or small leak from a large package)				LARGE SPILLS (From a large package or from many small packages)			
			First ISOLATE in all Directions		Then PROTECT persons Downwind during		First ISOLATE in all Directions		Then PROTECT persons Downwind during	
			Meters (Feet)	Kilometers (Miles)	DAY Kilometers (Miles)	NIGHT Kilometers (Miles)	Meters (Feet)	Kilometers (Miles)	DAY Kilometers (Miles)	NIGHT Kilometers (Miles)
1744	154	Bromine, solution (Inhalation Hazard Zone B)	30 m (100 ft)	0.1 km (0.1 mi)	0.2 km (0.1 mi)	0.1 km (0.1 mi)	30 m (100 ft)	0.4 km (0.3 mi)	0.5 km (0.3 mi)	
1745	144	Bromine pentafluoride (when spilled on land)	100 m (300 ft)	0.9 km (0.5 mi)	2.7 km (1.7 mi)	0.9 km (0.6 mi)	500 m (1500 ft)	5.7 km (3.6 mi)	10.8 km (6.7 mi)	
1745	144	Bromine pentafluoride (when spilled in water)	30 m (100 ft)	0.1 km (0.1 mi)	0.3 km (0.2 mi)	0.1 km (0.1 mi)	100 m (300 ft)	0.9 km (0.6 mi)	3.0 km (1.9 mi)	
1746	144	Bromine trifluoride (when spilled on land)	30 m (100 ft)	0.1 km (0.1 mi)	0.2 km (0.1 mi)	0.1 km (0.1 mi)	30 m (100 ft)	0.3 km (0.2 mi)	0.5 km (0.3 mi)	
1746	144	Bromine trifluoride (when spilled in water)	30 m (100 ft)	0.1 km (0.1 mi)	0.3 km (0.2 mi)	0.1 km (0.1 mi)	100 m (300 ft)	0.8 km (0.5 mi)	2.8 km (1.8 mi)	
1747	155	Butyltrichlorosilane (when spilled in water)	30 m (100 ft)	0.1 km (0.1 mi)	0.1 km (0.1 mi)	0.1 km (0.1 mi)	30 m (100 ft)	0.4 km (0.2 mi)	1.2 km (0.7 mi)	
1749	124	Chlorine trifluoride	30 m (100 ft)	0.2 km (0.2 mi)	1.1 km (0.7 mi)	0.2 km (0.2 mi)	300 m (1000 ft)	1.4 km (0.9 mi)	3.7 km (2.3 mi)	
1752	156	Chloroacetyl chloride (when spilled on land)	30 m (100 ft)	0.3 km (0.2 mi)	0.6 km (0.4 mi)	0.3 km (0.2 mi)	100 m (300 ft)	1.2 km (0.8 mi)	1.9 km (1.2 mi)	
1752	156	Chloroacetyl chloride (when spilled in water)	30 m (100 ft)	0.1 km (0.1 mi)	0.1 km (0.1 mi)	0.1 km (0.1 mi)	30 m (100 ft)	0.1 km (0.1 mi)	0.4 km (0.3 mi)	
1753	156	Chlorophenyltrichlorosilane (when spilled in water)	30 m (100 ft)	0.1 km (0.1 mi)	0.1 km (0.1 mi)	0.1 km (0.1 mi)	30 m (100 ft)	0.2 km (0.1 mi)	0.5 km (0.4 mi)	

1754	137	Chlorosulfonic acid (with or without sulfur trioxide) (when spilled on land)	30 m (100 ft)	0.1 km (0.1 mi)	0.1 km (0.1 mi)	30 m (100 ft)	0.3 km (0.2 mi)	0.3 km (0.2 mi)	0.3 km (0.2 mi)
1754	137	Chlorosulphonic acid (with or without sulphur trioxide) (when spilled on land)	30 m (100 ft)	0.1 km (0.1 mi)	0.1 km (0.1 mi)	30 m (100 ft)	0.3 km (0.2 mi)	0.3 km (0.2 mi)	0.3 km (0.2 mi)
1754	137	Chlorosulfonic acid (with or without sulfur trioxide) (when spilled in water)	30 m (100 ft)	0.1 km (0.1 mi)	0.1 km (0.1 mi)	60 m (200 ft)	0.5 km (0.3 mi)	0.5 km (0.3 mi)	1.7 km (1.1 mi)
1754	137	Chlorosulphonic acid (with or without sulphur trioxide) (when spilled in water)	30 m (100 ft)	0.1 km (0.1 mi)	0.1 km (0.1 mi)	60 m (200 ft)	0.5 km (0.3 mi)	0.5 km (0.3 mi)	1.7 km (1.1 mi)
1758	137	Chromium oxychloride (when spilled in water)	30 m (100 ft)	0.1 km (0.1 mi)	0.1 km (0.1 mi)	30 m (100 ft)	0.1 km (0.1 mi)	0.1 km (0.1 mi)	0.3 km (0.2 mi)
1762	156	Cyclohexenyltrichlorosilane (when spilled in water)	30 m (100 ft)	0.1 km (0.1 mi)	0.1 km (0.1 mi)	30 m (100 ft)	0.2 km (0.2 mi)	0.2 km (0.2 mi)	0.8 km (0.5 mi)
1763	156	Cyclohexyltrichlorosilane (when spilled in water)	30 m (100 ft)	0.1 km (0.1 mi)	0.1 km (0.1 mi)	30 m (100 ft)	0.2 km (0.2 mi)	0.2 km (0.2 mi)	0.8 km (0.5 mi)
1765	156	Dichloroacetyl chloride (when spilled in water)	30 m (100 ft)	0.1 km (0.1 mi)	0.1 km (0.1 mi)	30 m (100 ft)	0.1 km (0.1 mi)	0.1 km (0.1 mi)	0.5 km (0.3 mi)
1766	156	Dichlorophenyltrichlorosilane (when spilled in water)	30 m (100 ft)	0.1 km (0.1 mi)	0.1 km (0.1 mi)	30 m (100 ft)	0.4 km (0.3 mi)	0.4 km (0.3 mi)	1.4 km (0.9 mi)
1767	155	Diethylchlorosilane (when spilled in water)	30 m (100 ft)	0.1 km (0.1 mi)	0.1 km (0.1 mi)	30 m (100 ft)	0.2 km (0.2 mi)	0.2 km (0.2 mi)	0.6 km (0.4 mi)
1769	156	Diphenylchlorosilane (when spilled in water)	30 m (100 ft)	0.1 km (0.1 mi)	0.1 km (0.1 mi)	30 m (100 ft)	0.2 km (0.2 mi)	0.2 km (0.2 mi)	0.7 km (0.5 mi)
1771	156	Dodecyltrichlorosilane (when spilled in water)	30 m (100 ft)	0.1 km (0.1 mi)	0.1 km (0.1 mi)	30 m (100 ft)	0.3 km (0.2 mi)	0.3 km (0.2 mi)	0.8 km (0.5 mi)

"+" means distance can be larger in certain atmospheric conditions

TABLE 1

TABLE 1 - INITIAL ISOLATION AND PROTECTIVE ACTION DISTANCES

ID No.	Guide No.	Name of Material	SMALL SPILLS (From a small package or small leak from a large package)				LARGE SPILLS (From a large package or from many small packages)			
			First ISOLATE in all Directions		Then PROTECT persons Downwind during		First ISOLATE in all Directions		Then PROTECT persons Downwind during	
			Meters (Feet)	Kilometers (Miles)	DAY Kilometers (Miles)	NIGHT Kilometers (Miles)	Meters (Feet)	Kilometers (Miles)	DAY Kilometers (Miles)	NIGHT Kilometers (Miles)
1777	137	Fluorosulfonic acid (when spilled in water)	30 m (100 ft)	0.1 km (0.1 mi)	0.1 km (0.1 mi)	0.1 km (0.1 mi)	30 m (100 ft)	0.1 km (0.1 mi)	0.3 km (0.2 mi)	
1777	137	Fluorosulphonic acid (when spilled in water)	30 m (100 ft)	0.1 km (0.1 mi)	0.1 km (0.1 mi)	0.1 km (0.1 mi)	30 m (100 ft)	0.1 km (0.1 mi)	0.3 km (0.2 mi)	
1781	156	Hexadecyltrichlorosilane (when spilled in water)	30 m (100 ft)	0.1 km (0.1 mi)	0.1 km (0.1 mi)	0.1 km (0.1 mi)	30 m (100 ft)	0.1 km (0.1 mi)	0.3 km (0.2 mi)	
1784	156	Hexyltrichlorosilane (when spilled in water)	30 m (100 ft)	0.1 km (0.1 mi)	0.1 km (0.1 mi)	0.1 km (0.1 mi)	30 m (100 ft)	0.3 km (0.2 mi)	0.9 km (0.6 mi)	
1799	156	Nonyltrichlorosilane (when spilled in water)	30 m (100 ft)	0.1 km (0.1 mi)	0.1 km (0.1 mi)	0.1 km (0.1 mi)	30 m (100 ft)	0.3 km (0.2 mi)	1.0 km (0.6 mi)	
1800	156	Octadecyltrichlorosilane (when spilled in water)	30 m (100 ft)	0.1 km (0.1 mi)	0.1 km (0.1 mi)	0.1 km (0.1 mi)	30 m (100 ft)	0.3 km (0.2 mi)	0.9 km (0.6 mi)	
1801	156	Octyltrichlorosilane (when spilled in water)	30 m (100 ft)	0.1 km (0.1 mi)	0.1 km (0.1 mi)	0.1 km (0.1 mi)	30 m (100 ft)	0.3 km (0.2 mi)	1.0 km (0.6 mi)	
1804	156	Phenyltrichlorosilane (when spilled in water)	30 m (100 ft)	0.1 km (0.1 mi)	0.1 km (0.1 mi)	0.1 km (0.1 mi)	30 m (100 ft)	0.3 km (0.2 mi)	1.0 km (0.6 mi)	
1806	137	Phosphorus pentachloride (when spilled in water)	30 m (100 ft)	0.1 km (0.1 mi)	0.1 km (0.1 mi)	0.1 km (0.1 mi)	30 m (100 ft)	0.2 km (0.2 mi)	0.9 km (0.6 mi)	
1808	137	Phosphorus tribromide (when spilled in water)	30 m (100 ft)	0.1 km (0.1 mi)	0.1 km (0.1 mi)	0.1 km (0.1 mi)	30 m (100 ft)	0.3 km (0.2 mi)	1.1 km (0.7 mi)	
1809	137	Phosphorus trichloride (when spilled on land)	30 m (100 ft)	0.2 km (0.2 mi)	0.6 km (0.4 mi)	0.6 km (0.4 mi)	100 m (300 ft)	1.1 km (0.7 mi)	2.0 km (1.3 mi)	

1809	137	Phosphorus trichloride (when spilled in water)	30 m (100 ft)	0.1 km (0.1 mi)	0.1 km (0.1 mi)	60 m (200 ft)	0.5 km (0.3 mi)	1.8 km (1.1 mi)
1810	137	Phosphorus oxychloride (when spilled on land)	30 m (100 ft)	0.3 km (0.2 mi)	0.6 km (0.4 mi)	100 m (300 ft)	1.1 km (0.7 mi)	1.8 km (1.2 mi)
1810	137	Phosphorus oxychloride (when spilled in water)	30 m (100 ft)	0.1 km (0.1 mi)	0.1 km (0.1 mi)	60 m (200 ft)	0.5 km (0.3 mi)	1.5 km (1.0 mi)
1815	155	Propionyl chloride (when spilled in water)	30 m (100 ft)	0.1 km (0.1 mi)	0.1 km (0.1 mi)	30 m (100 ft)	0.1 km (0.1 mi)	0.3 km (0.2 mi)
1816	155	Propyltrichlorosilane (when spilled in water)	30 m (100 ft)	0.1 km (0.1 mi)	0.1 km (0.1 mi)	30 m (100 ft)	0.4 km (0.3 mi)	1.3 km (0.8 mi)
1818	157	Silicon tetrachloride (when spilled in water)	30 m (100 ft)	0.1 km (0.1 mi)	0.1 km (0.1 mi)	60 m (200 ft)	0.6 km (0.4 mi)	2.0 km (1.3 mi)
1828	137	Sulfur chlorides (when spilled on land)	30 m (100 ft)	0.1 km (0.1 mi)	0.1 km (0.1 mi)	60 m (200 ft)	0.3 km (0.2 mi)	0.4 km (0.3 mi)
1828	137	Sulphur chlorides (when spilled on land)	30 m (100 ft)	0.1 km (0.1 mi)	0.1 km (0.1 mi)	30 m (100 ft)	0.2 km (0.1 mi)	0.7 km (0.4 mi)
1828	137	Sulfur chlorides (when spilled in water)	30 m (100 ft)	0.1 km (0.1 mi)	0.1 km (0.1 mi)	300 m (1000 ft)	2.9 km (1.8 mi)	6.3 km (4.0 mi)
1828	137	Sulphur chlorides (when spilled in water)	30 m (100 ft)	0.1 km (0.1 mi)	0.1 km (0.1 mi)	300 m (1000 ft)	2.9 km (1.8 mi)	6.3 km (4.0 mi)
1829	137	Sulfur trioxide, stabilized	60 m (200 ft)	0.4 km (0.2 mi)	1.0 km (0.6 mi)	300 m (1000 ft)	2.9 km (1.8 mi)	6.3 km (4.0 mi)
1829	137	Sulphur trioxide, stabilized	60 m (200 ft)	0.4 km (0.2 mi)	1.0 km (0.6 mi)	300 m (1000 ft)	2.9 km (1.8 mi)	6.3 km (4.0 mi)
1831	137	Sulfuric acid, fuming	30 m (100 ft)	0.2 km (0.1 mi)	0.4 km (0.3 mi)	60 m (200 ft)	0.8 km (0.5 mi)	1.5 km (0.9 mi)
1831	137	Sulphuric acid, fuming	30 m (100 ft)	0.2 km (0.1 mi)	0.4 km (0.3 mi)	60 m (200 ft)	0.8 km (0.5 mi)	1.5 km (0.9 mi)
1834	137	Sulfonyl chloride (when spilled on land)	30 m (100 ft)	0.2 km (0.1 mi)	0.4 km (0.3 mi)	60 m (200 ft)	0.8 km (0.5 mi)	1.5 km (0.9 mi)
1834	137	Sulphonyl chloride (when spilled on land)	30 m (100 ft)	0.2 km (0.1 mi)	0.4 km (0.3 mi)	60 m (200 ft)	0.8 km (0.5 mi)	1.5 km (0.9 mi)

"+" means distance can be larger in certain atmospheric conditions

TABLE 1

TABLE 1 - INITIAL ISOLATION AND PROTECTIVE ACTION DISTANCES

		SMALL SPILLS (From a small package or small leak from a large package)			LARGE SPILLS (From a large package or from many small packages)		
ID No.	Guide No.	Name of Material	First ISOLATE	Then PROTECT	First ISOLATE	Then PROTECT	
			in all Directions Meters (Feet)	persons Downwind during DAY NIGHT Kilometers (Miles) (Miles)	in all Directions Meters (Feet)	persons Downwind during DAY NIGHT Kilometers (Miles) (Miles)	
1834	137	Sulfuryl chloride (when spilled in water)	30 m (100 ft)	0.1 km (0.1 mi) 0.1 km (0.1 mi)	30 m (100 ft)	0.3 km (0.2 mi) 1.1 km (0.7 mi)	
1834	137	Sulphuryl chloride (when spilled in water)	30 m (100 ft)	0.1 km (0.1 mi) 0.2 km (0.2 mi)	30 m (100 ft)	0.3 km (0.2 mi) 0.5 km (0.4 mi)	
1836	137	Thionyl chloride (when spilled on land)	100 m (300 ft)	0.9 km (0.6 mi) 2.9 km (1.8 mi)	600 m (2000 ft)	7.6 km (4.7 mi) 11.0+ km (7.0+ mi)	
1838	137	Titanium tetrachloride (when spilled in water)	30 m (100 ft)	0.1 km (0.1 mi) 0.2 km (0.1 mi)	30 m (100 ft)	0.4 km (0.3 mi) 0.5 km (0.3 mi)	
1838	137	Titanium tetrachloride (when spilled in water)	30 m (100 ft)	0.1 km (0.1 mi) 0.1 km (0.1 mi)	30 m (100 ft)	0.3 km (0.2 mi) 1.2 km (0.7 mi)	
1859	125	Silicon tetrafluoride	30 m (100 ft)	0.2 km (0.1 mi) 0.8 km (0.5 mi)	100 m (300 ft)	0.5 km (0.3 mi) 1.8 km (1.2 mi)	
1859	125	Silicon tetrafluoride, compressed	30 m (100 ft)	0.2 km (0.1 mi) 2.2 km (1.4 mi)	400 m (1250 ft)	5.1 km (3.2 mi) 6.4 km (4.0 mi)	
1892	151	Ethyldichloroarsine	150 m (500 ft)	1.5 km (1.0 mi) 0.1 km (0.1 mi)	30 m (100 ft)	0.3 km (0.2 mi) 0.9 km (0.6 mi)	
1898	156	Acetyl iodide (when spilled in water)	30 m (100 ft)	0.1 km (0.1 mi) 1.2 km (0.7 mi)	300 m (1000 ft)	1.6 km (1.0 mi) 4.6 km (2.9 mi)	
1911	119	Diborane	60 m (200 ft)				
1911	119	Diborane mixtures					

1923	135	Calcium dithionite (when spilled in water)	30 m (100 ft)	0.1 km (0.1 mi)	0.4 km (0.3 mi)	60 m (200 ft)	0.5 km (0.4 mi)	2.1 km (1.3 mi)
1923	135	Calcium hydrosulfite (when spilled in water)						
1923	135	Calcium hydrosulphite (when spilled in water)						
1929	135	Potassium dithionite (when spilled in water)	30 m (100 ft)	0.1 km (0.1 mi)	0.4 km (0.2 mi)	60 m (200 ft)	0.5 km (0.3 mi)	1.9 km (1.2 mi)
1929	135	Potassium hydrosulfite (when spilled in water)						
1929	135	Potassium hydrosulphite (when spilled in water)						
1931	171	Zinc dithionite (when spilled in water)	30 m (100 ft)	0.1 km (0.1 mi)	0.4 km (0.2 mi)	60 m (200 ft)	0.5 km (0.3 mi)	1.9 km (1.2 mi)
1931	171	Zinc hydrosulfite (when spilled in water)						
1931	171	Zinc hydrosulphite (when spilled in water)						
1953	119	Compressed gas, poisonous, flammable, n.o.s.						
1953	119	Compressed gas, poisonous, flammable, n.o.s. (Inhalation Hazard Zone A)	150 m (500 ft)	1.0 km (0.6 mi)	3.9 km (2.4 mi)	1000 m (3000 ft)	6.2 km (3.9 mi)	10.5 km (6.5 mi)
1953	119	Compressed gas, poisonous, flammable, n.o.s. (Inhalation Hazard Zone B)	30 m (100 ft)	0.1 km (0.1 mi)	0.4 km (0.2 mi)	300 m (1000 ft)	1.4 km (0.9 mi)	3.1 km (1.9 mi)
1953	119	Compressed gas, poisonous, flammable, n.o.s. (Inhalation Hazard Zone C)	30 m (100 ft)	0.1 km (0.1 mi)	0.3 km (0.2 mi)	150 m (500 ft)	1.0 km (0.6 mi)	2.7 km (1.7 mi)
1953	119	Compressed gas, poisonous, flammable, n.o.s. (Inhalation Hazard Zone D)						

"+" means distance can be larger in certain atmospheric conditions

TABLE 1

TABLE 1 - INITIAL ISOLATION AND PROTECTIVE ACTION DISTANCES

ID No.	Guide No.	Name of Material	SMALL SPILLS (From a small package or small leak from a large package)				LARGE SPILLS (From a large package or from many small packages)			
			First ISOLATE in all Directions		Then PROTECT persons Downwind during		First ISOLATE in all Directions		Then PROTECT persons Downwind during	
			Meters (Feet)	(Miles)	Kilometers (Miles)	NIGHT Kilometers (Miles)	Meters (Feet)	(Miles)	Kilometers (Miles)	NIGHT Kilometers (Miles)
1953	119	Compressed gas, toxic, flammable, n.o.s.	150 m (500 ft)	0.6 mi (0.2 mi)	3.9 km (2.4 mi)	1000 m (3000 ft)	6.2 km (3.9 mi)	10.5 km (6.5 mi)		
1953	119	Compressed gas, toxic, flammable, n.o.s. (Inhalation Hazard Zone A)	30 m (100 ft)	0.1 mi (0.1 mi)	0.4 km (0.2 mi)	300 m (1000 ft)	1.4 km (0.9 mi)	3.1 km (1.9 mi)		
1953	119	Compressed gas, toxic, flammable, n.o.s. (Inhalation Hazard Zone B)	30 m (100 ft)	0.1 mi (0.1 mi)	0.3 km (0.2 mi)	150 m (500 ft)	1.0 km (0.6 mi)	2.7 km (1.7 mi)		
1955	123	Compressed gas, poisonous, n.o.s.	150 m (500 ft)	0.6 mi (0.2 mi)	3.9 km (2.4 mi)	1000 m (3000 ft)	6.2 km (3.9 mi)	10.5 km (6.5 mi)		
1955	123	Compressed gas, poisonous, n.o.s. (Inhalation Hazard Zone A)	30 m (100 ft)	0.2 mi (0.2 mi)	1.1 km (0.7 mi)	300 m (1000 ft)	1.4 km (0.9 mi)	3.7 km (2.3 mi)		

1955	123	Compressed gas, poisonous, n.o.s. (Inhalation Hazard Zone C)	30 m (100 ft)	0.1 km (0.1 mi)	0.3 km (0.2 mi)	150 m (500 ft)	1.0 km (0.6 mi)	2.7 km (1.7 mi)
1955	123	Compressed gas, poisonous, n.o.s. (Inhalation Hazard Zone D)	150 m (500 ft)	1.0 km (0.6 mi)	3.9 km (2.4 mi)	1000 m (3000 ft)	6.2 km (3.9 mi)	10.5 km (6.5 mi)
1955	123	Compressed gas, toxic, n.o.s. (Inhalation Hazard Zone A)	30 m (100 ft)	0.2 km (0.2 mi)	1.1 km (0.7 mi)	300 m (1000 ft)	1.4 km (0.9 mi)	3.7 km (2.3 mi)
1955	123	Compressed gas, toxic, n.o.s. (Inhalation Hazard Zone B)	30 m (100 ft)	0.1 km (0.1 mi)	0.3 km (0.2 mi)	150 m (500 ft)	1.0 km (0.6 mi)	2.7 km (1.7 mi)
1955	123	Organic phosphate compound mixed with compressed gas	100 m (300 ft)	1.0 km (0.7 mi)	3.4 km (2.1 mi)	500 m (1500 ft)	4.4 km (2.7 mi)	9.6 km (6.0 mi)
1967	123	Insecticide gas, poisonous, n.o.s.	100 m (300 ft)	1.0 km (0.7 mi)	3.4 km (2.1 mi)	500 m (1500 ft)	4.4 km (2.7 mi)	9.6 km (6.0 mi)
1975	124	Nitric oxide and dinitrogen tetroxide mixture	30 m (100 ft)	0.1 km (0.1 mi)	0.6 km (0.4 mi)	100 m (300 ft)	0.6 km (0.4 mi)	2.2 km (1.4 mi)
1994	136	Iron pentacarbonyl	100 m (300 ft)	0.9 km (0.6 mi)	2.1 km (1.3 mi)	400 m (1250 ft)	5.2 km (3.2 mi)	7.8 km (4.8 mi)

"+" means distance can be larger in certain atmospheric conditions

TABLE 1

TABLE 1 - INITIAL ISOLATION AND PROTECTIVE ACTION DISTANCES

		SMALL SPILLS (From a small package or small leak from a large package)				LARGE SPILLS (From a large package or from many small packages)				
ID No.	Guide No.	Name of Material	First ISOLATE in all Directions		Then PROTECT persons Downwind during		First ISOLATE in all Directions		Then PROTECT persons Downwind during	
			Meters (Feet)	(Miles)	DAY Kilometers (Miles)	NIGHT Kilometers (Miles)	Meters (Feet)	(Feet)	DAY Kilometers (Miles)	NIGHT Kilometers (Miles)
2004	135	Magnesium diamide (when spilled in water)	30 m (100 ft)	0.1 km (0.1 mi)	0.3 km (0.2 mi)	0.1 km (0.1 mi)	0.3 km (0.2 mi)	60 m (200 ft)	0.5 km (0.3 mi)	1.8 km (1.1 mi)
2011	139	Magnesium phosphide (when spilled in water)	30 m (100 ft)	0.1 km (0.1 mi)	0.6 km (0.4 mi)	0.1 km (0.1 mi)	0.6 km (0.4 mi)	400 m (1250 ft)	1.4 km (0.9 mi)	3.9 km (2.4 mi)
2012	139	Potassium phosphide (when spilled in water)	30 m (100 ft)	0.1 km (0.1 mi)	0.3 km (0.2 mi)	0.1 km (0.1 mi)	0.3 km (0.2 mi)	200 m (600 ft)	0.9 km (0.6 mi)	2.8 km (1.8 mi)
2013	139	Strontium phosphide (when spilled in water)	30 m (100 ft)	0.1 km (0.1 mi)	0.3 km (0.2 mi)	0.1 km (0.1 mi)	0.3 km (0.2 mi)	200 m (600 ft)	0.8 km (0.5 mi)	2.7 km (1.7 mi)
2032	157	Nitric acid, red fuming	30 m (100 ft)	0.1 km (0.1 mi)	0.1 km (0.1 mi)	0.1 km (0.1 mi)	0.1 km (0.1 mi)	150 m (500 ft)	0.3 km (0.2 mi)	0.5 km (0.3 mi)
2186	125	Hydrogen chloride, refrigerated liquid	30 m (100 ft)	0.1 km (0.1 mi)	0.3 km (0.2 mi)	0.1 km (0.1 mi)	0.3 km (0.2 mi)	Refer to Table 3		
2188	119	Arsine	150 m (500 ft)	1.0 km (0.6 mi)	3.9 km (2.4 mi)	1.0 km (0.6 mi)	3.9 km (2.4 mi)			
2189	119	Dichlorosilane	30 m (100 ft)	0.1 km (0.1 mi)	0.4 km (0.2 mi)	0.1 km (0.1 mi)	0.4 km (0.2 mi)	300 m (1000 ft)	1.4 km (0.9 mi)	3.1 km (1.9 mi)
2190	124	Oxygen difluoride, compressed	300 m (1000 ft)	1.8 km (1.1 mi)	7.2 km (4.5 mi)	1.8 km (1.1 mi)	7.2 km (4.5 mi)	1000 m (3000 ft)	11.0+ km (7.0+ mi)	11.0+ km (7.0+ mi)
2191	123	Sulfuryl fluoride	30 m (100 ft)	0.1 km (0.1 mi)	0.5 km (0.3 mi)	0.1 km (0.1 mi)	0.5 km (0.3 mi)	400 m (1250 ft)	2.2 km (1.4 mi)	5.0 km (3.1 mi)
2191	123	Sulphuryl fluoride	30 m (100 ft)	0.1 km (0.1 mi)	0.5 km (0.3 mi)	0.1 km (0.1 mi)	0.5 km (0.3 mi)	400 m (1250 ft)	2.2 km (1.4 mi)	5.0 km (3.1 mi)
2192	119	Germane	150 m (500 ft)	0.9 km (0.5 mi)	3.3 km (2.1 mi)	0.9 km (0.5 mi)	3.3 km (2.1 mi)	600 m (2000 ft)	3.6 km (2.3 mi)	7.4 km (4.6 mi)
2194	125	Selenium hexafluoride	200 m (600 ft)	1.1 km (0.7 mi)	3.4 km (2.1 mi)	1.1 km (0.7 mi)	3.4 km (2.1 mi)	600 m (2000 ft)	3.9 km (2.4 mi)	7.6 km (4.8 mi)
2195	125	Tellurium hexafluoride	1000 m (3000 ft)	5.9 km (3.7 mi)	11.1 km (6.9 mi)	5.9 km (3.7 mi)	11.1 km (6.9 mi)	1000 m (3000 ft)	11.0+ km (7.0+ mi)	11.0+ km (7.0+ mi)
2196	125	Tungsten hexafluoride	30 m (100 ft)	0.2 km (0.1 mi)	0.8 km (0.5 mi)	0.2 km (0.1 mi)	0.8 km (0.5 mi)	150 m (500 ft)	0.8 km (0.5 mi)	2.8 km (1.7 mi)
2197	125	Hydrogen iodide, anhydrous	30 m (100 ft)	0.1 km (0.1 mi)	0.3 km (0.2 mi)	0.1 km (0.1 mi)	0.3 km (0.2 mi)	150 m (500 ft)	1.0 km (0.6 mi)	2.7 km (1.7 mi)

2198	125	Phosphorus pentafluoride	30 m (100 ft)	0.2 km (0.2 mi)	1.0 km (0.7 mi)	200 m (600 ft)	1.1 km (0.7 mi)	3.5 km (2.2 mi)
2198	125	Phosphorus pentafluoride, compressed	60 m (200 ft)	0.3 km (0.2 mi)	1.1 km (0.7 mi)	400 m (1250 ft)	1.3 km (0.8 mi)	3.7 km (2.3 mi)
2199	119	Phosphine	300 m (1000 ft)	1.7 km (1.1 mi)	6.0 km (3.7 mi)	1000 m (3000 ft)	11.0+ km (7.0+ mi)	11.0+ km (7.0+ mi)
2202	117	Hydrogen selenide, anhydrous	30 m (100 ft)	0.1 km (0.1 mi)	0.3 km (0.2 mi)	300 m (1000 ft)	1.5 km (1.0 mi)	3.6 km (2.3 mi)
2204	119	Carbonyl sulfide	30 m (100 ft)	0.2 km (0.1 mi)	0.3 km (0.2 mi)	60 m (200 ft)	0.7 km (0.4 mi)	1.1 km (0.7 mi)
2204	119	Carbonyl sulphide	30 m (100 ft)	0.2 km (0.1 mi)	0.3 km (0.2 mi)	60 m (200 ft)	0.7 km (0.4 mi)	1.1 km (0.7 mi)
2232	153	Chloroacetaldehyde	30 m (100 ft)	0.2 km (0.1 mi)	0.2 km (0.1 mi)	60 m (200 ft)	0.5 km (0.3 mi)	0.6 km (0.4 mi)
2232	153	2-Chloroethanal	30 m (100 ft)	0.2 km (0.1 mi)	0.2 km (0.1 mi)	60 m (200 ft)	0.5 km (0.3 mi)	0.6 km (0.4 mi)
2285	155	Isocyanatobenzotrifluorides	30 m (100 ft)	0.2 km (0.1 mi)	0.2 km (0.1 mi)	60 m (200 ft)	0.5 km (0.3 mi)	0.6 km (0.4 mi)
2308	157	Nitrosylsulfuric acid, liquid (when spilled in water)	30 m (100 ft)	0.1 km (0.1 mi)	0.3 km (0.2 mi)	300 m (1000 ft)	0.8 km (0.5 mi)	2.3 km (1.4 mi)
2308	157	Nitrosylsulphuric acid, liquid (when spilled in water)	30 m (100 ft)	0.1 km (0.1 mi)	0.3 km (0.2 mi)	300 m (1000 ft)	0.8 km (0.5 mi)	2.3 km (1.4 mi)
2334	131	Allylamine	30 m (100 ft)	0.2 km (0.1 mi)	0.5 km (0.4 mi)	150 m (500 ft)	1.6 km (1.0 mi)	2.5 km (1.6 mi)
2337	131	Phenyl mercaptan	30 m (100 ft)	0.1 km (0.1 mi)	0.1 km (0.1 mi)	30 m (100 ft)	0.3 km (0.2 mi)	0.4 km (0.2 mi)
2353	155	Butyl chloride (when spilled in water)	30 m (100 ft)	0.1 km (0.1 mi)	0.1 km (0.1 mi)	30 m (100 ft)	0.2 km (0.1 mi)	0.5 km (0.3 mi)
2382	131	Dimethylhydrazine, symmetrical	30 m (100 ft)	0.2 km (0.1 mi)	0.3 km (0.2 mi)	60 m (200 ft)	0.8 km (0.5 mi)	1.3 km (0.8 mi)
2395	155	Isobutryl chloride (when spilled in water)	30 m (100 ft)	0.1 km (0.1 mi)	0.1 km (0.1 mi)	30 m (100 ft)	0.1 km (0.1 mi)	0.3 km (0.2 mi)
2407	155	Isopropyl chloroformate	30 m (100 ft)	0.1 km (0.1 mi)	0.2 km (0.2 mi)	60 m (200 ft)	0.5 km (0.4 mi)	0.9 km (0.6 mi)
2417	125	Carbonyl fluoride	100 m (300 ft)	0.7 km (0.5 mi)	2.5 km (1.6 mi)	600 m (2000 ft)	3.8 km (2.4 mi)	8.2 km (5.1 mi)
2418	125	Sulfur tetrafluoride	100 m (300 ft)	0.5 km (0.3 mi)	2.4 km (1.5 mi)	400 m (1250 ft)	2.4 km (1.5 mi)	5.9 km (3.7 mi)
2418	125	Sulphur tetrafluoride	100 m (300 ft)	0.5 km (0.3 mi)	2.4 km (1.5 mi)	400 m (1250 ft)	2.4 km (1.5 mi)	5.9 km (3.7 mi)
2420	125	Hexafluoroacetone	100 m (300 ft)	0.7 km (0.4 mi)	2.7 km (1.7 mi)	1000 m (3000 ft)	11.0+ km (7.0+ mi)	11.0+ km (7.0+ mi)

"+" means distance can be larger in certain atmospheric conditions

TABLE 1

TABLE 1 - INITIAL ISOLATION AND PROTECTIVE ACTION DISTANCES

		SMALL SPILLS (From a small package or small leak from a large package)				LARGE SPILLS (From a large package or from many small packages)				
ID No.	Guide No.	Name of Material	First ISOLATE in all Directions		Then PROTECT persons Downwind during		First ISOLATE in all Directions		Then PROTECT persons Downwind during	
			Meters (Feet)	Kilometers (Miles)	DAY Kilometers (Miles)	NIGHT Kilometers (Miles)	Meters (Feet)	Kilometers (Miles)	DAY Kilometers (Miles)	NIGHT Kilometers (Miles)
2421	124	Nitrogen trioxide	60 m (200 ft)	0.3 km (0.2 mi)	1.2 km (0.8 mi)	200 m (600 ft)	1.4 km (0.9 mi)	4.3 km (2.7 mi)		
2434	156	Dibenzylchlorosilane (when spilled in water)	30 m (100 ft)	0.1 km (0.1 mi)	0.1 km (0.1 mi)	30 m (100 ft)	0.1 km (0.1 mi)	0.3 km (0.2 mi)		
2435	156	Ethylphenyldichlorosilane (when spilled in water)	30 m (100 ft)	0.1 km (0.1 mi)	0.1 km (0.1 mi)	30 m (100 ft)	0.2 km (0.1 mi)	0.6 km (0.4 mi)		
2437	156	Methylphenyldichlorosilane (when spilled in water)	30 m (100 ft)	0.1 km (0.1 mi)	0.1 km (0.1 mi)	30 m (100 ft)	0.2 km (0.2 mi)	0.8 km (0.5 mi)		
2438	131	Trimethylacetyl chloride	60 m (200 ft)	0.5 km (0.3 mi)	1.0 km (0.7 mi)	200 m (600 ft)	2.3 km (1.5 mi)	3.3 km (2.1 mi)		
2442	156	Trichloroacetyl chloride	30 m (100 ft)	0.2 km (0.1 mi)	0.3 km (0.2 mi)	60 m (200 ft)	0.7 km (0.5 mi)	1.1 km (0.7 mi)		
2474	156	Thiophosgene	60 m (200 ft)	0.6 km (0.4 mi)	1.8 km (1.1 mi)	200 m (600 ft)	2.3 km (1.4 mi)	4.2 km (2.6 mi)		
2477	131	Methyl isothiocyanate	30 m (100 ft)	0.1 km (0.1 mi)	0.1 km (0.1 mi)	30 m (100 ft)	0.3 km (0.2 mi)	0.4 km (0.3 mi)		
2478	155	Isocyanate solution, flammable, poisonous, n.o.s.								
2478	155	Isocyanate solution, flammable, toxic, n.o.s.	60 m (200 ft)	0.8 km (0.5 mi)	1.8 km (1.2 mi)	400 m (1250 ft)	4.7 km (3.0 mi)	7.0 km (4.4 mi)		
2478	155	Isocyanates, flammable, poisonous, n.o.s.								
2478	155	Isocyanates, flammable, toxic, n.o.s.								
2480	155P	Methyl isocyanate	150 m (500 ft)	1.7 km (1.1 mi)	5.2 km (3.3 mi)	1000 m (3000 ft)	11.0+ km (7.0+ mi)	11.0+ km (7.0+ mi)		
2481	155	Ethyl isocyanate	150 m (500 ft)	2.0 km (1.3 mi)	5.3 km (3.3 mi)	1000 m (3000 ft)	11.0+ km (7.0+ mi)	11.0+ km (7.0+ mi)		
2482	155P	n-Propyl isocyanate	100 m (300 ft)	1.3 km (0.8 mi)	2.8 km (1.8 mi)	600 m (2000 ft)	7.8 km (4.8 mi)	10.7 km (6.6 mi)		

2483	155P	Isopropyl isocyanate	150 m (500 ft)	1.5 km (1.0 mi)	3.3 km (2.1 mi)	1000 m (3000 ft)	11.0+ km (7.0+ mi)	11.0+ km (7.0+ mi)
2484	155	tert-Butyl isocyanate	60 m (200 ft)	0.8 km (0.5 mi)	1.8 km (1.2 mi)	400 m (1250 ft)	4.7 km (3.0 mi)	7.0 km (4.4 mi)
2485	155P	n-Butyl isocyanate	60 m (200 ft)	0.6 km (0.4 mi)	1.2 km (0.8 mi)	300 m (1000 ft)	2.9 km (1.8 mi)	4.2 km (2.6 mi)
2486	155P	Isobutyl isocyanate	60 m (200 ft)	0.6 km (0.4 mi)	1.3 km (0.8 mi)	300 m (1000 ft)	3.4 km (2.1 mi)	4.8 km (3.0 mi)
2487	155	Phenyl isocyanate	100 m (300 ft)	0.9 km (0.6 mi)	1.5 km (0.9 mi)	400 m (1250 ft)	4.2 km (2.6 mi)	5.4 km (3.4 mi)
2488	155	Cyclohexyl isocyanate	30 m (100 ft)	0.3 km (0.2 mi)	0.4 km (0.3 mi)	100 m (300 ft)	1.1 km (0.7 mi)	1.4 km (0.9 mi)
2495	144	Iodine pentaffluoride (when spilled in water)	30 m (100 ft)	0.1 km (0.1 mi)	0.3 km (0.2 mi)	100 m (300 ft)	0.9 km (0.6 mi)	3.2 km (2.0 mi)
2521	131P	Diketene, stabilized	30 m (100 ft)	0.2 km (0.1 mi)	0.3 km (0.2 mi)	60 m (200 ft)	0.7 km (0.4 mi)	1.0 km (0.6 mi)
2534	119	Methylchlorosilane	30 m (100 ft)	0.1 km (0.1 mi)	0.3 km (0.2 mi)	150 m (500 ft)	0.8 km (0.5 mi)	1.8 km (1.1 mi)
2548	124	Chlorine pentafluoride	100 m (300 ft)	0.5 km (0.3 mi)	2.5 km (1.6 mi)	800 m (2500 ft)	5.1 km (3.2 mi)	11.0+ km (7.0+ mi)
2605	155	Methoxymethyl isocyanate	30 m (100 ft)	0.2 km (0.1 mi)	0.2 km (0.2 mi)	60 m (200 ft)	0.7 km (0.4 mi)	0.9 km (0.6 mi)
2606	155	Methyl orthosilicate	30 m (100 ft)	0.2 km (0.1 mi)	0.3 km (0.2 mi)	60 m (200 ft)	0.7 km (0.5 mi)	1.1 km (0.7 mi)
2644	151	Methyl iodide	30 m (100 ft)	0.1 km (0.1 mi)	0.2 km (0.1 mi)	100 m (300 ft)	0.3 km (0.2 mi)	0.7 km (0.4 mi)
2646	151	Hexachlorocyclopentadiene	30 m (100 ft)	0.1 km (0.1 mi)	0.1 km (0.1 mi)	30 m (100 ft)	0.3 km (0.2 mi)	0.3 km (0.2 mi)
2668	131	Chloroacetonitrile	30 m (100 ft)	0.1 km (0.1 mi)	0.1 km (0.1 mi)	30 m (100 ft)	0.3 km (0.2 mi)	0.4 km (0.2 mi)
2676	119	Sitbine	60 m (200 ft)	0.3 km (0.2 mi)	1.6 km (1.0 mi)	200 m (600 ft)	1.3 km (0.8 mi)	4.1 km (2.6 mi)
2691	137	Phosphorus pentabromide (when spilled in water)	30 m (100 ft)	0.1 km (0.1 mi)	0.1 km (0.1 mi)	30 m (100 ft)	0.1 km (0.1 mi)	0.4 km (0.3 mi)
2692	157	Boron tribromide (when spilled on land)	30 m (100 ft)	0.1 km (0.1 mi)	0.2 km (0.1 mi)	30 m (100 ft)	0.2 km (0.1 mi)	0.4 km (0.3 mi)
2692	157	Boron tribromide (when spilled in water)	30 m (100 ft)	0.1 km (0.1 mi)	0.1 km (0.1 mi)	30 m (100 ft)	0.4 km (0.3 mi)	1.4 km (0.9 mi)
2740	155	n-Propyl chloroformate	30 m (100 ft)	0.1 km (0.1 mi)	0.3 km (0.2 mi)	60 m (200 ft)	0.6 km (0.4 mi)	1.0 km (0.7 mi)

"+" means distance can be larger in certain atmospheric conditions

TABLE 1

TABLE 1 - INITIAL ISOLATION AND PROTECTIVE ACTION DISTANCES

		SMALL SPILLS (From a small package or small leak from a large package)			LARGE SPILLS (From a large package or from many small packages)			
ID No.	Guide No.	Name of Material	First ISOLATE	Then PROTECT		First ISOLATE	Then PROTECT	
			in all Directions Meters (Feet)	persons Downwind during DAY	NIGHT	in all Directions Meters (Feet)	persons Downwind during DAY	NIGHT
			(Kilometers (Miles))	(Kilometers (Miles))	(Kilometers (Miles))	(Kilometers (Miles))	(Kilometers (Miles))	(Kilometers (Miles))
2742	155	Chloroformates, poisonous, corrosive, flammable, n.o.s.	30 m (100 ft)	0.2 km (0.1 mi)	0.2 km (0.2 mi)	60 m (200 ft)	0.5 km (0.3 mi)	0.7 km (0.5 mi)
2742	155	Chloroformates, toxic, corrosive, flammable, n.o.s.	30 m (100 ft)	0.1 km (0.1 mi)	0.1 km (0.1 mi)	30 m (100 ft)	0.3 km (0.2 mi)	0.4 km (0.3 mi)
2806	139	Lithium nitride (when spilled in water)	30 m (100 ft)	0.1 km (0.1 mi)	0.2 km (0.2 mi)	60 m (200 ft)	0.4 km (0.3 mi)	1.6 km (1.0 mi)
2826	155	Ethyl chloroformate	30 m (100 ft)	0.2 km (0.1 mi)	0.2 km (0.2 mi)	60 m (200 ft)	0.5 km (0.3 mi)	0.7 km (0.5 mi)
2845	135	Ethyl phosphonous dichloride, anhydrous	30 m (100 ft)	0.3 km (0.2 mi)	0.7 km (0.5 mi)	100 m (300 ft)	1.4 km (0.9 mi)	2.3 km (1.4 mi)
2845	135	Methyl phosphonous dichloride	30 m (100 ft)	0.4 km (0.3 mi)	1.2 km (0.7 mi)	200 m (600 ft)	2.6 km (1.6 mi)	4.2 km (2.6 mi)
2901	124	Bromine chloride	100 m (300 ft)	0.5 km (0.3 mi)	1.8 km (1.1 mi)	1000 m (3000 ft)	5.7 km (3.5 mi)	11.0+ km (7.0+ mi)
2927	154	Ethyl phosphonothioic dichloride, anhydrous	30 m (100 ft)	0.1 km (0.1 mi)	0.1 km (0.1 mi)	30 m (100 ft)	0.2 km (0.1 mi)	0.2 km (0.1 mi)
2927	154	Ethyl phosphorodichloridate	30 m (100 ft)	0.1 km (0.1 mi)	0.1 km (0.1 mi)	30 m (100 ft)	0.3 km (0.2 mi)	0.3 km (0.2 mi)
2965	139	Boron trifluoride dimethyl etherate (when spilled in water)	30 m (100 ft)	0.1 km (0.1 mi)	0.2 km (0.2 mi)	100 m (300 ft)	0.9 km (0.6 mi)	2.8 km (1.7 mi)

2977	166	Radioactive material, uranium hexafluoride, fissile (when spilled in water)	30 m (100 ft)	0.1 km (0.1 mi)	0.2 km (0.1 mi)	0.1 mi (0.1 mi)	30 m (100 ft)	0.4 km (0.2 mi)	1.6 km (1.0 mi)
2977	166	Uranium hexafluoride, radioactive material, fissile (when spilled in water)	30 m (100 ft)	0.1 km (0.1 mi)	0.2 km (0.1 mi)	0.1 mi (0.1 mi)	30 m (100 ft)	0.4 km (0.2 mi)	1.6 km (1.0 mi)
2978	166	Radioactive material, uranium hexafluoride, non fissile or fissile-excepted (when spilled in water)	30 m (100 ft)	0.1 km (0.1 mi)	0.2 km (0.1 mi)	0.1 mi (0.1 mi)	30 m (100 ft)	0.4 km (0.2 mi)	1.6 km (1.0 mi)
2978	166	Uranium hexafluoride, radioactive material, non fissile or fissile-excepted (when spilled in water)	30 m (100 ft)	0.1 km (0.1 mi)	0.2 km (0.1 mi)	0.1 mi (0.1 mi)	30 m (100 ft)	0.4 km (0.2 mi)	1.6 km (1.0 mi)
2985	155	Chlorosilanes, flammable, corrosive, n.o.s. (when spilled in water)	30 m (100 ft)	0.1 km (0.1 mi)	0.2 km (0.1 mi)	0.1 mi (0.1 mi)	60 m (200 ft)	0.5 km (0.3 mi)	1.6 km (1.0 mi)
2986	155	Chlorosilanes, corrosive, flammable, n.o.s. (when spilled in water)	30 m (100 ft)	0.1 km (0.1 mi)	0.2 km (0.1 mi)	0.1 mi (0.1 mi)	60 m (200 ft)	0.5 km (0.3 mi)	1.6 km (1.0 mi)
2987	156	Chlorosilanes, corrosive, n.o.s. (when spilled in water)	30 m (100 ft)	0.1 km (0.1 mi)	0.2 km (0.1 mi)	0.1 mi (0.1 mi)	60 m (200 ft)	0.5 km (0.3 mi)	1.6 km (1.0 mi)
2988	139	Chlorosilanes, water-reactive, flammable, corrosive, n.o.s. (when spilled in water)	30 m (100 ft)	0.1 km (0.1 mi)	0.2 km (0.1 mi)	0.1 mi (0.1 mi)	60 m (200 ft)	0.5 km (0.3 mi)	1.6 km (1.0 mi)
3023	131	2-Methyl-2-heptanethiol	30 m (100 ft)	0.2 km (0.1 mi)	0.2 km (0.1 mi)	0.1 mi (0.1 mi)	60 m (200 ft)	0.6 km (0.4 mi)	0.8 km (0.5 mi)
3048	157	Aluminum phosphide pesticide (when spilled in water)	30 m (100 ft)	0.1 km (0.1 mi)	0.7 km (0.4 mi)	0.4 mi (0.4 mi)	400 m (1250 ft)	1.6 km (1.0 mi)	4.5 km (2.8 mi)
3057	125	Trifluoroacetyl chloride	30 m (100 ft)	0.2 km (0.1 mi)	0.9 km (0.6 mi)	0.6 mi (0.6 mi)	800 m (2500 ft)	4.9 km (3.1 mi)	11.0+ km (7.0+ mi)

"+" means distance can be larger in certain atmospheric conditions

TABLE 1

TABLE 1 - INITIAL ISOLATION AND PROTECTIVE ACTION DISTANCES

		SMALL SPILLS (From a small package or small leak from a large package)				LARGE SPILLS (From a large package or from many small packages)				
ID No.	Guide No.	Name of Material	First ISOLATE in all Directions		Then PROTECT persons Downwind during		First ISOLATE in all Directions		Then PROTECT persons Downwind during	
			Meters (Feet)	Kilometers (Miles)	DAY Kilometers (Miles)	NIGHT Kilometers (Miles)	Meters (Feet)	Kilometers (Miles)	DAY Kilometers (Miles)	NIGHT Kilometers (Miles)
3079	131P	Methacrylonitrile, stabilized	30 m (100 ft)	0.3 km (0.2 mi)	0.7 km (0.5 mi)	0.3 km (0.2 mi)	0.7 km (0.5 mi)	150 m (500 ft)	1.7 km (1.1 mi)	2.8 km (1.7 mi)
3083	124	Perchloryl fluoride	30 m (100 ft)	0.2 km (0.2 mi)	1.1 km (0.7 mi)	0.2 km (0.2 mi)	1.1 km (0.7 mi)	1000 m (3000 ft)	5.5 km (3.4 mi)	10.9 km (6.8 mi)
3160	119	Liquefied gas, poisonous, flammable, n.o.s.								
3160	119	Liquefied gas, poisonous, flammable, n.o.s. (Inhalation Hazard Zone A)	150 m (500 ft)	1.0 km (0.6 mi)	3.9 km (2.4 mi)	1.0 km (0.6 mi)	3.9 km (2.4 mi)	1000 m (3000 ft)	6.2 km (3.9 mi)	10.5 km (6.5 mi)
3160	119	Liquefied gas, poisonous, flammable, n.o.s. (Inhalation Hazard Zone B)	30 m (100 ft)	0.1 km (0.1 mi)	0.4 km (0.2 mi)	0.1 km (0.1 mi)	0.4 km (0.2 mi)	300 m (1000 ft)	1.4 km (0.9 mi)	3.1 km (1.9 mi)
3160	119	Liquefied gas, poisonous, flammable, n.o.s. (Inhalation Hazard Zone C)								
3160	119	Liquefied gas, poisonous, flammable, n.o.s. (Inhalation Hazard Zone D)	30 m (100 ft)	0.1 km (0.1 mi)	0.3 km (0.2 mi)	0.1 km (0.1 mi)	0.3 km (0.2 mi)	150 m (500 ft)	1.0 km (0.6 mi)	2.7 km (1.7 mi)
3160	119	Liquefied gas, toxic, flammable, n.o.s.								
3160	119	Liquefied gas, toxic, flammable, n.o.s. (Inhalation Hazard Zone A)	150 m (500 ft)	1.0 km (0.6 mi)	3.9 km (2.4 mi)	1.0 km (0.6 mi)	3.9 km (2.4 mi)	1000 m (3000 ft)	6.2 km (3.9 mi)	10.5 km (6.5 mi)
3160	119	Liquefied gas, toxic, flammable, n.o.s. (Inhalation Hazard Zone B)	30 m (100 ft)	0.1 km (0.1 mi)	0.4 km (0.2 mi)	0.1 km (0.1 mi)	0.4 km (0.2 mi)	300 m (1000 ft)	1.4 km (0.9 mi)	3.1 km (1.9 mi)

3160	119	Liquefied gas, toxic, flammable, n.o.s. (Inhalation Hazard Zone C)	30 m (100 ft)	0.1 km (0.1 mi)	0.3 km (0.2 mi)	150 m (500 ft)	1.0 km (0.6 mi)	2.7 km (1.7 mi)
3160	119	Liquefied gas, toxic, flammable, n.o.s. (Inhalation Hazard Zone D)	30 m (100 ft)	1.0 km (0.6 mi)	3.9 km (2.4 mi)	1000 m (3000 ft)	6.2 km (3.9 mi)	10.5 km (6.5 mi)
3162	123	Liquefied gas, poisonous, n.o.s. (Inhalation Hazard Zone A)	30 m (100 ft)	0.2 km (0.2 mi)	1.1 km (0.7 mi)	300 m (1000 ft)	1.4 km (0.9 mi)	3.7 km (2.3 mi)
3162	123	Liquefied gas, poisonous, n.o.s. (Inhalation Hazard Zone C)	30 m (100 ft)	0.1 km (0.1 mi)	0.3 km (0.2 mi)	150 m (500 ft)	1.0 km (0.6 mi)	2.7 km (1.7 mi)
3162	123	Liquefied gas, poisonous, n.o.s. (Inhalation Hazard Zone D)	150 m (500 ft)	1.0 km (0.6 mi)	3.9 km (2.4 mi)	1000 m (3000 ft)	6.2 km (3.9 mi)	10.5 km (6.5 mi)
3162	123	Liquefied gas, toxic, n.o.s. (Inhalation Hazard Zone A)	30 m (100 ft)	0.2 km (0.2 mi)	1.1 km (0.7 mi)	300 m (1000 ft)	1.4 km (0.9 mi)	3.7 km (2.3 mi)
3162	123	Liquefied gas, toxic, n.o.s. (Inhalation Hazard Zone B)	30 m (100 ft)	0.1 km (0.1 mi)	0.3 km (0.2 mi)	150 m (500 ft)	1.0 km (0.6 mi)	2.7 km (1.7 mi)
3162	123	Liquefied gas, toxic, n.o.s. (Inhalation Hazard Zone C)	30 m (100 ft)	0.1 km (0.1 mi)	0.3 km (0.2 mi)	150 m (500 ft)	1.0 km (0.6 mi)	2.7 km (1.7 mi)
3162	123	Liquefied gas, toxic, n.o.s. (Inhalation Hazard Zone D)	30 m (100 ft)	0.2 km (0.2 mi)	0.3 km (0.2 mi)	60 m (200 ft)	0.7 km (0.5 mi)	1.0 km (0.6 mi)
3246	156	Methanesulfonyl chloride	30 m (100 ft)	0.3 km (0.2 mi)	0.7 km (0.5 mi)	150 m (500 ft)	1.7 km (1.1 mi)	2.8 km (1.7 mi)
3246	156	Methanesulphonyl chloride	30 m (100 ft)	0.3 km (0.2 mi)	0.7 km (0.5 mi)	150 m (500 ft)	1.7 km (1.1 mi)	2.8 km (1.7 mi)
3275	131	Nitriles, poisonous, flammable, n.o.s.						
3275	131	Nitriles, toxic, flammable, n.o.s.						

"+" means distance can be larger in certain atmospheric conditions

TABLE 1

TABLE 1 - INITIAL ISOLATION AND PROTECTIVE ACTION DISTANCES

ID No.	Guide No.	Name of Material	SMALL SPILLS (From a small package or small leak from a large package)				LARGE SPILLS (From a large package or from many small packages)			
			First ISOLATE in all Directions		Then PROTECT persons Downwind during		First ISOLATE in all Directions		Then PROTECT persons Downwind during	
			Meters (Feet)	(Miles)	Kilometers (Miles)	NIGHT (Miles)	Meters (Feet)	(Miles)	Kilometers (Miles)	NIGHT (Miles)
3276	151	Nitriles, liquid, poisonous, n.o.s.	30 m (100 ft)	0.3 km (0.2 mi)	0.7 km (0.5 mi)	150 m (500 ft)	1.7 km (1.1 mi)	2.8 km (1.7 mi)		
3276	151	Nitriles, liquid, toxic, n.o.s.								
3276	151	Nitriles, poisonous, liquid, n.o.s.								
3276	151	Nitriles, toxic, liquid, n.o.s.								
3278	151	Organophosphorus compound, liquid, poisonous, n.o.s.	30 m (100 ft)	0.4 km (0.3 mi)	1.2 km (0.7 mi)	200 m (600 ft)	2.6 km (1.6 mi)	4.2 km (2.6 mi)		
3278	151	Organophosphorus compound, liquid, toxic, n.o.s.								
3279	131	Organophosphorus compound, poisonous, flammable, n.o.s.	30 m (100 ft)	0.4 km (0.3 mi)	1.2 km (0.7 mi)	200 m (600 ft)	2.6 km (1.6 mi)	4.2 km (2.6 mi)		
3279	131	Organophosphorus compound, toxic, flammable, n.o.s.								
3280	151	Organoarsenic compound, liquid, n.o.s.	30 m (100 ft)	0.2 km (0.1 mi)	0.7 km (0.5 mi)	150 m (500 ft)	1.7 km (1.1 mi)	3.6 km (2.2 mi)		
3281	151	Metal carbonyls, liquid, n.o.s.	100 m (300 ft)	1.4 km (0.9 mi)	5.2 km (3.3 mi)	1000 m (3000 ft)	11.0+ km (7.0+ mi)	11.0+ km (7.0+ mi)		
3294	131	Hydrogen cyanide, solution in alcohol, with not more than 45% hydrogen cyanide	30 m (100 ft)	0.1 km (0.1 mi)	0.2 km (0.2 mi)	150 m (500 ft)	0.7 km (0.5 mi)	2.0 km (1.2 mi)		
3300	119P	Ethylene oxide and carbon dioxide mixture, with more than 87% ethylene oxide	30 m (100 ft)	0.1 km (0.1 mi)	0.2 km (0.2 mi)	150 m (500 ft)	0.7 km (0.5 mi)	2.0 km (1.2 mi)		

3303	124	Compressed gas, poisonous, oxidizing, n.o.s.	100 m (300 ft)	0.5 km (0.3 mi)	2.5 km (1.6 mi)	800 m (2500 ft)	5.1 km (3.2 mi)	11.0+ km (7.0+ mi)
3303	124	Compressed gas, poisonous, oxidizing, n.o.s. (Inhalation Hazard Zone A)	30 m (100 ft)	0.2 km (0.2 mi)	1.1 km (0.7 mi)	500 m (1500 ft)	3.5 km (2.2 mi)	9.9 km (6.2 mi)
3303	124	Compressed gas, poisonous, oxidizing, n.o.s. (Inhalation Hazard Zone B)	30 m (100 ft)	0.1 km (0.1 mi)	0.6 km (0.4 mi)	100 m (300 ft)	0.6 km (0.4 mi)	2.2 km (1.4 mi)
3303	124	Compressed gas, toxic, oxidizing, n.o.s. (Inhalation Hazard Zone C)	100 m (300 ft)	0.5 km (0.3 mi)	2.5 km (1.6 mi)	800 m (2500 ft)	5.1 km (3.2 mi)	11.0+ km (7.0+ mi)
3303	124	Compressed gas, toxic, oxidizing, n.o.s. (Inhalation Hazard Zone D)	30 m (100 ft)	0.2 km (0.2 mi)	1.1 km (0.7 mi)	500 m (1500 ft)	3.5 km (2.2 mi)	9.9 km (6.2 mi)
3303	124	Compressed gas, toxic, oxidizing, n.o.s. (Inhalation Hazard Zone B)	30 m (100 ft)	0.1 km (0.1 mi)	0.6 km (0.4 mi)	100 m (300 ft)	0.6 km (0.4 mi)	2.2 km (1.4 mi)
3303	124	Compressed gas, toxic, oxidizing, n.o.s. (Inhalation Hazard Zone C)	30 m (100 ft)	0.1 km (0.1 mi)	0.6 km (0.4 mi)	100 m (300 ft)	0.6 km (0.4 mi)	2.2 km (1.4 mi)
3303	124	Compressed gas, toxic, oxidizing, n.o.s. (Inhalation Hazard Zone D)						

"+" means distance can be larger in certain atmospheric conditions

TABLE 1

TABLE 1 - INITIAL ISOLATION AND PROTECTIVE ACTION DISTANCES

		SMALL SPILLS (From a small package or small leak from a large package)				LARGE SPILLS (From a large package or from many small packages)				
ID No.	Guide No.	Name of Material	First ISOLATE in all Directions		Then PROTECT persons Downwind during		First ISOLATE in all Directions		Then PROTECT persons Downwind during	
			Meters (Feet)	Kilometers (Miles)	DAY Kilometers (Miles)	NIGHT Kilometers (Miles)	Meters (Feet)	Kilometers (Miles)	DAY Kilometers (Miles)	NIGHT Kilometers (Miles)
3304	125	Compressed gas, poisonous, corrosive, n.o.s.	200 m (600 ft)	1.1 km (0.7 mi)	3.4 km (2.1 mi)	600 m (2000 ft)	3.9 km (2.4 mi)	7.6 km (4.8 mi)		
3304	125	Compressed gas, poisonous, corrosive, n.o.s. (Inhalation Hazard Zone A)	30 m (100 ft)	0.2 km (0.2 mi)	1.1 km (0.7 mi)	300 m (1000 ft)	1.6 km (1.0 mi)	3.7 km (2.3 mi)		
3304	125	Compressed gas, poisonous, corrosive, n.o.s. (Inhalation Hazard Zone B)	30 m (100 ft)	0.1 km (0.1 mi)	0.5 km (0.3 mi)	300 m (1000 ft)	1.4 km (0.9 mi)	3.2 km (2.0 mi)		
3304	125	Compressed gas, poisonous, corrosive, n.o.s. (Inhalation Hazard Zone D)	30 m (100 ft)	0.1 km (0.1 mi)	0.2 km (0.1 mi)	150 m (500 ft)	0.8 km (0.5 mi)	2.0 km (1.3 mi)		
3304	125	Compressed gas, toxic, corrosive, n.o.s.	200 m (600 ft)	1.1 km (0.7 mi)	3.4 km (2.1 mi)	600 m (2000 ft)	3.9 km (2.4 mi)	7.6 km (4.8 mi)		
3304	125	Compressed gas, toxic, corrosive, n.o.s. (Inhalation Hazard Zone A)	30 m (100 ft)	0.2 km (0.2 mi)	1.1 km (0.7 mi)	300 m (1000 ft)	1.6 km (1.0 mi)	3.7 km (2.3 mi)		
3304	125	Compressed gas, toxic, corrosive, n.o.s. (Inhalation Hazard Zone B)	30 m (100 ft)	0.1 km (0.1 mi)	0.5 km (0.3 mi)	300 m (1000 ft)	1.4 km (0.9 mi)	3.2 km (2.0 mi)		

3304	125	Compressed gas, toxic, corrosive, n.o.s. (Inhalation Hazard Zone D)	30 m (100 ft)	0.1 km (0.1 mi)	0.2 km (0.1 mi)	150 m (500 ft)	0.8 km (0.5 mi)	2.0 km (1.3 mi)
3305	119	Compressed gas, poisonous, flammable, corrosive, n.o.s.						
3305	119	Compressed gas, poisonous, flammable, corrosive, n.o.s. (Inhalation Hazard Zone A)	150 m (500 ft)	1.0 km (0.6 mi)	3.9 km (2.4 mi)	1000 m (3000 ft)	6.2 km (3.9 mi)	10.5 km (6.5 mi)
3305	119	Compressed gas, poisonous, flammable, corrosive, n.o.s. (Inhalation Hazard Zone B)	30 m (100 ft)	0.1 km (0.1 mi)	0.4 km (0.2 mi)	300 m (1000 ft)	1.4 km (0.9 mi)	3.1 km (1.9 mi)
3305	119	Compressed gas, poisonous, flammable, corrosive, n.o.s. (Inhalation Hazard Zone C)						
3305	119	Compressed gas, poisonous, flammable, corrosive, n.o.s. (Inhalation Hazard Zone D)	30 m (100 ft)	0.1 km (0.1 mi)	0.3 km (0.2 mi)	150 m (500 ft)	1.0 km (0.6 mi)	2.7 km (1.7 mi)
3305	119	Compressed gas, toxic, flammable, corrosive, n.o.s.						
3305	119	Compressed gas, toxic, flammable, corrosive, n.o.s. (Inhalation Hazard Zone A)	150 m (500 ft)	1.0 km (0.6 mi)	3.9 km (2.4 mi)	1000 m (3000 ft)	6.2 km (3.9 mi)	10.5 km (6.5 mi)
3305	119	Compressed gas, toxic, flammable, corrosive, n.o.s. (Inhalation Hazard Zone B)	30 m (100 ft)	0.1 km (0.1 mi)	0.4 km (0.2 mi)	300 m (1000 ft)	1.4 km (0.9 mi)	3.1 km (1.9 mi)
3305	119	Compressed gas, toxic, flammable, corrosive, n.o.s. (Inhalation Hazard Zone C)						
3305	119	Compressed gas, toxic, flammable, corrosive, n.o.s. (Inhalation Hazard Zone D)	30 m (100 ft)	0.1 km (0.1 mi)	0.3 km (0.2 mi)	150 m (500 ft)	1.0 km (0.6 mi)	2.7 km (1.7 mi)

"+" means distance can be larger in certain atmospheric conditions

TABLE 1

TABLE 1 - INITIAL ISOLATION AND PROTECTIVE ACTION DISTANCES

		SMALL SPILLS (From a small package or small leak from a large package)				LARGE SPILLS (From a large package or from many small packages)				
ID No.	Guide No.	Name of Material	ISOLATE in all Directions		PROTECT persons Downwind during		ISOLATE in all Directions		PROTECT persons Downwind during	
			Meters (Feet)	Miles (Kilometers)	DAY Kilometers (Miles)	NIGHT Kilometers (Miles)	Meters (Feet)	Miles (Kilometers)	DAY Kilometers (Miles)	NIGHT Kilometers (Miles)
3306	124	Compressed gas, poisonous, oxidizing, corrosive, n.o.s.	100 m (300 ft)	0.5 km (0.3 mi)	2.5 km (1.6 mi)	1000 m (3000 ft)	5.5 km (3.4 mi)	11.0+ km (7.0+ mi)		
3306	124	Compressed gas, poisonous, oxidizing, corrosive, n.o.s. (Inhalation Hazard Zone A)	30 m (100 ft)	0.2 km (0.2 mi)	1.1 km (0.7 mi)	800 m (2500 ft)	5.1 km (3.2 mi)	10.9 km (6.8 mi)		
3306	124	Compressed gas, poisonous, oxidizing, corrosive, n.o.s. (Inhalation Hazard Zone C)	30 m (100 ft)	0.1 km (0.1 mi)	0.5 km (0.3 mi)	300 m (1000 ft)	1.6 km (1.0 mi)	3.2 km (2.0 mi)		
3306	124	Compressed gas, poisonous, oxidizing, corrosive, n.o.s. (Inhalation Hazard Zone D)	30 m (100 ft)	0.1 km (0.1 mi)	0.2 km (0.1 mi)	150 m (500 ft)	0.8 km (0.5 mi)	2.0 km (1.3 mi)		
3306	124	Compressed gas, toxic, oxidizing, corrosive, n.o.s. (Inhalation Hazard Zone A)	100 m (300 ft)	0.5 km (0.3 mi)	2.5 km (1.6 mi)	1000 m (3000 ft)	5.5 km (3.4 mi)	11.0+ km (7.0+ mi)		
3306	124	Compressed gas, toxic, oxidizing, corrosive, n.o.s. (Inhalation Hazard Zone B)	30 m (100 ft)	0.2 km (0.2 mi)	1.1 km (0.7 mi)	800 m (2500 ft)	5.1 km (3.2 mi)	10.9 km (6.8 mi)		
3306	124	Compressed gas, toxic, oxidizing, corrosive, n.o.s. (Inhalation Hazard Zone C)	30 m (100 ft)	0.1 km (0.1 mi)	0.5 km (0.3 mi)	300 m (1000 ft)	1.6 km (1.0 mi)	3.2 km (2.0 mi)		

3306	124 Compressed gas, toxic, oxidizing, corrosive, n.o.s. (Inhalation Hazard Zone D)	30 m (100 ft)	0.1 km (0.1 mi)	0.2 km (0.1 mi)	150 m (500 ft)	0.8 km (0.5 mi)	2.0 km (1.3 mi)
3307	124 Liquefied gas, poisonous, oxidizing, n.o.s.	100 m (300 ft)	0.5 km (0.3 mi)	2.5 km (1.6 mi)	800 m (2500 ft)	5.1 km (3.2 mi)	11.0+ km (7.0+ mi)
3307	124 Liquefied gas, poisonous, oxidizing, n.o.s. (Inhalation Hazard Zone A)	30 m (100 ft)	0.2 km (0.2 mi)	1.1 km (0.7 mi)	500 m (1500 ft)	2.8 km (1.8 mi)	10.9 km (6.8 mi)
3307	124 Liquefied gas, poisonous, oxidizing, n.o.s. (Inhalation Hazard Zone B)	30 m (100 ft)	0.1 km (0.1 mi)	0.6 km (0.4 mi)	100 m (300 ft)	0.6 km (0.4 mi)	2.2 km (1.4 mi)
3307	124 Liquefied gas, toxic, oxidizing, n.o.s. (Inhalation Hazard Zone C)	100 m (300 ft)	0.5 km (0.3 mi)	2.5 km (1.6 mi)	800 m (2500 ft)	5.1 km (3.2 mi)	11.0+ km (7.0+ mi)
3307	124 Liquefied gas, toxic, oxidizing, n.o.s. (Inhalation Hazard Zone D)	30 m (100 ft)	0.2 km (0.2 mi)	1.1 km (0.7 mi)	500 m (1500 ft)	2.8 km (1.8 mi)	10.9 km (6.8 mi)
3307	124 Liquefied gas, toxic, oxidizing, n.o.s. (Inhalation Hazard Zone B)	30 m (100 ft)	0.1 km (0.1 mi)	0.6 km (0.4 mi)	100 m (300 ft)	0.6 km (0.4 mi)	2.2 km (1.4 mi)
3307	124 Liquefied gas, toxic, oxidizing, n.o.s. (Inhalation Hazard Zone C)	100 m (300 ft)	0.5 km (0.3 mi)	2.5 km (1.6 mi)	800 m (2500 ft)	5.1 km (3.2 mi)	11.0+ km (7.0+ mi)
3307	124 Liquefied gas, toxic, oxidizing, n.o.s. (Inhalation Hazard Zone D)	30 m (100 ft)	0.2 km (0.2 mi)	1.1 km (0.7 mi)	500 m (1500 ft)	2.8 km (1.8 mi)	10.9 km (6.8 mi)
3307	124 Liquefied gas, toxic, oxidizing, n.o.s. (Inhalation Hazard Zone C)	100 m (300 ft)	0.5 km (0.3 mi)	2.5 km (1.6 mi)	800 m (2500 ft)	5.1 km (3.2 mi)	11.0+ km (7.0+ mi)
3307	124 Liquefied gas, toxic, oxidizing, n.o.s. (Inhalation Hazard Zone D)	30 m (100 ft)	0.2 km (0.2 mi)	1.1 km (0.7 mi)	500 m (1500 ft)	2.8 km (1.8 mi)	10.9 km (6.8 mi)

"+" means distance can be larger in certain atmospheric conditions

TABLE 1

TABLE 1 - INITIAL ISOLATION AND PROTECTIVE ACTION DISTANCES

		SMALL SPILLS (From a small package or small leak from a large package)				LARGE SPILLS (From a large package or from many small packages)				
ID No.	Guide No.	Name of Material	First ISOLATE in all Directions		Then PROTECT persons Downwind during		First ISOLATE in all Directions		Then PROTECT persons Downwind during	
			Meters (Feet)	(Miles)	Kilometers (Miles)	NIGHT Kilometers (Miles)	Meters (Feet)	(Miles)	Kilometers (Miles)	NIGHT Kilometers (Miles)
3308	125	Liquefied gas, poisonous, corrosive, n.o.s.	200 m (600 ft)	1.1 km (0.7 mi)	3.4 km (2.1 mi)	600 m (2000 ft)	3.9 km (2.4 mi)	7.6 km (4.8 mi)		
3308	125	Liquefied gas, poisonous, corrosive, n.o.s. (Inhalation Hazard Zone A)	30 m (100 ft)	0.3 km (0.2 mi)	1.1 km (0.7 mi)	300 m (1000 ft)	1.6 km (1.0 mi)	3.7 km (2.3 mi)		
3308	125	Liquefied gas, poisonous, corrosive, n.o.s. (Inhalation Hazard Zone B)	30 m (100 ft)	0.1 km (0.1 mi)	0.5 km (0.3 mi)	300 m (1000 ft)	1.4 km (0.9 mi)	3.2 km (2.0 mi)		
3308	125	Liquefied gas, poisonous, corrosive, n.o.s. (Inhalation Hazard Zone C)	30 m (100 ft)	0.1 km (0.1 mi)	0.2 km (0.1 mi)	150 m (500 ft)	0.8 km (0.5 mi)	2.0 km (1.3 mi)		
3308	125	Liquefied gas, toxic, corrosive, n.o.s. (Inhalation Hazard Zone D)	200 m (600 ft)	1.1 km (0.7 mi)	3.4 km (2.1 mi)	600 m (2000 ft)	3.9 km (2.4 mi)	7.6 km (4.8 mi)		
3308	125	Liquefied gas, toxic, corrosive, n.o.s. (Inhalation Hazard Zone A)	30 m (100 ft)	0.3 km (0.2 mi)	1.1 km (0.7 mi)	300 m (1000 ft)	1.6 km (1.0 mi)	3.7 km (2.3 mi)		
3308	125	Liquefied gas, toxic, corrosive, n.o.s. (Inhalation Hazard Zone B)	30 m (100 ft)	0.1 km (0.1 mi)	0.5 km (0.3 mi)	300 m (1000 ft)	1.4 km (0.9 mi)	3.2 km (2.0 mi)		

3308	125	Liquefied gas, toxic, corrosive, n.o.s. (Inhalation Hazard Zone D)	30 m (100 ft)	0.1 km (0.1 mi)	0.2 km (0.1 mi)	150 m (500 ft)	0.8 km (0.5 mi)	2.0 km (1.3 mi)
3309	119	Liquefied gas, poisonous, flammable, corrosive, n.o.s.						
3309	119	Liquefied gas, poisonous, flammable, corrosive, n.o.s. (Inhalation Hazard Zone A)	150 m (500 ft)	1.0 km (0.6 mi)	3.9 km (2.4 mi)	1000 m (3000 ft)	6.2 km (3.9 mi)	10.5 km (6.5 mi)
3309	119	Liquefied gas, poisonous, flammable, corrosive, n.o.s. (Inhalation Hazard Zone B)	30 m (100 ft)	0.3 km (0.2 mi)	0.6 km (0.4 mi)	300 m (1000 ft)	2.5 km (1.6 mi)	3.1 km (1.9 mi)
3309	119	Liquefied gas, poisonous, flammable, corrosive, n.o.s. (Inhalation Hazard Zone C)						
3309	119	Liquefied gas, poisonous, flammable, corrosive, n.o.s. (Inhalation Hazard Zone D)	30 m (100 ft)	0.1 km (0.1 mi)	0.3 km (0.2 mi)	150 m (500 ft)	1.0 km (0.6 mi)	2.7 km (1.7 mi)
3309	119	Liquefied gas, toxic, flammable, corrosive, n.o.s.						
3309	119	Liquefied gas, toxic, flammable, corrosive, n.o.s. (Inhalation Hazard Zone A)	150 m (500 ft)	1.0 km (0.6 mi)	3.9 km (2.4 mi)	1000 m (3000 ft)	6.2 km (3.9 mi)	10.5 km (6.5 mi)
3309	119	Liquefied gas, toxic, flammable, corrosive, n.o.s. (Inhalation Hazard Zone B)	30 m (100 ft)	0.3 km (0.2 mi)	0.6 km (0.4 mi)	300 m (1000 ft)	2.5 km (1.6 mi)	3.1 km (1.9 mi)
3309	119	Liquefied gas, toxic, flammable, corrosive, n.o.s. (Inhalation Hazard Zone C)						
3309	119	Liquefied gas, toxic, flammable, corrosive, n.o.s. (Inhalation Hazard Zone D)	30 m (100 ft)	0.1 km (0.1 mi)	0.3 km (0.2 mi)	150 m (500 ft)	1.0 km (0.6 mi)	2.7 km (1.7 mi)

"+" means distance can be larger in certain atmospheric conditions

TABLE 1

TABLE 1 - INITIAL ISOLATION AND PROTECTIVE ACTION DISTANCES

		SMALL SPILLS (From a small package or small leak from a large package)				LARGE SPILLS (From a large package or from many small packages)				
ID No.	Guide No.	Name of Material	First ISOLATE in all Directions		Then PROTECT persons Downwind during		First ISOLATE in all Directions		Then PROTECT persons Downwind during	
			Meters (Feet)	(Kilometers (Miles))	DAY (Kilometers (Miles))	NIGHT (Kilometers (Miles))	Meters (Feet)	(Kilometers (Miles))	DAY (Kilometers (Miles))	NIGHT (Kilometers (Miles))
3310	124	Liquefied gas, poisonous, oxidizing, corrosive, n.o.s.	100 m (300 ft)	0.5 km (0.3 mi)	2.5 km (1.6 mi)	1000 m (3000 ft)	5.1 km (3.2 mi)	11.0+ km (7.0+ mi)		
3310	124	Liquefied gas, poisonous, oxidizing, corrosive, n.o.s. (Inhalation Hazard Zone A)	30 m (100 ft)	0.2 km (0.2 mi)	1.1 km (0.7 mi)	800 m (2500 ft)	4.5 km (2.8 mi)	10.9 km (6.8 mi)		
3310	124	Liquefied gas, poisonous, oxidizing, corrosive, n.o.s. (Inhalation Hazard Zone B)	30 m (100 ft)	0.1 km (0.1 mi)	0.5 km (0.3 mi)	300 m (1000 ft)	1.6 km (1.0 mi)	3.2 km (2.0 mi)		
3310	124	Liquefied gas, poisonous, oxidizing, corrosive, n.o.s. (Inhalation Hazard Zone C)	30 m (100 ft)	0.1 km (0.1 mi)	0.2 km (0.1 mi)	150 m (500 ft)	0.8 km (0.5 mi)	2.0 km (1.3 mi)		
3310	124	Liquefied gas, toxic, oxidizing, corrosive, n.o.s. (Inhalation Hazard Zone D)	100 m (300 ft)	0.5 km (0.3 mi)	2.5 km (1.6 mi)	1000 m (3000 ft)	5.1 km (3.2 mi)	11.0+ km (7.0+ mi)		
3310	124	Liquefied gas, toxic, oxidizing, corrosive, n.o.s. (Inhalation Hazard Zone A)	30 m (100 ft)	0.2 km (0.2 mi)	1.1 km (0.7 mi)	800 m (2500 ft)	4.5 km (2.8 mi)	10.9 km (6.8 mi)		
3310	124	Liquefied gas, toxic, oxidizing, corrosive, n.o.s. (Inhalation Hazard Zone B)	30 m (100 ft)	0.1 km (0.1 mi)	0.5 km (0.3 mi)	300 m (1000 ft)	1.6 km (1.0 mi)	3.2 km (2.0 mi)		

3310	124	Liquefied gas, toxic, oxidizing, corrosive, n.o.s. (Inhalation Hazard Zone D)	30 m (100 ft)	0.1 km (0.1 mi)	0.2 km (0.1 mi)	0.1 mi	150 m (500 ft)	0.8 km (0.5 mi)	2.0 km (1.3 mi)
3318	125	Ammonia solution, with more than 50% ammonia	30 m (100 ft)	0.1 km (0.1 mi)	0.2 km (0.1 mi)	0.1 mi	150 m (500 ft)	0.8 km (0.5 mi)	2.0 km (1.3 mi)
3355	119	Insecticide gas, poisonous, flammable, n.o.s.	150 m (500 ft)	1.0 km (0.6 mi)	3.9 km (2.4 mi)	2.4 mi	1000 m (3000 ft)	6.2 km (3.9 mi)	10.5 km (6.5 mi)
3355	119	Insecticide gas, poisonous, flammable, n.o.s. (Inhalation Hazard Zone A)	30 m (100 ft)	0.1 km (0.1 mi)	0.4 km (0.2 mi)	0.2 mi	300 m (1000 ft)	1.4 km (0.9 mi)	3.1 km (1.9 mi)
3355	119	Insecticide gas, poisonous, flammable, n.o.s. (Inhalation Hazard Zone B)	30 m (100 ft)	0.1 km (0.1 mi)	0.3 km (0.2 mi)	0.2 mi	150 m (500 ft)	1.0 km (0.6 mi)	2.7 km (1.7 mi)
3355	119	Insecticide gas, poisonous, flammable, n.o.s. (Inhalation Hazard Zone C)	30 m (100 ft)	0.1 km (0.1 mi)	0.3 km (0.2 mi)	0.2 mi	150 m (500 ft)	0.6 km (0.4 mi)	1.6 km (1.0 mi)
3355	119	Insecticide gas, toxic, flammable, n.o.s. (Inhalation Hazard Zone D)	150 m (500 ft)	1.0 km (0.6 mi)	3.9 km (2.4 mi)	2.4 mi	1000 m (3000 ft)	6.2 km (3.9 mi)	10.5 km (6.5 mi)
3355	119	Insecticide gas, toxic, flammable, n.o.s. (Inhalation Hazard Zone A)	30 m (100 ft)	0.1 km (0.1 mi)	0.4 km (0.2 mi)	0.2 mi	300 m (1000 ft)	1.4 km (0.9 mi)	3.1 km (1.9 mi)
3355	119	Insecticide gas, toxic, flammable, n.o.s. (Inhalation Hazard Zone B)	30 m (100 ft)	0.1 km (0.1 mi)	0.3 km (0.2 mi)	0.2 mi	150 m (500 ft)	1.0 km (0.6 mi)	2.7 km (1.7 mi)
3355	119	Insecticide gas, toxic, flammable, n.o.s. (Inhalation Hazard Zone C)	30 m (100 ft)	0.1 km (0.1 mi)	0.3 km (0.2 mi)	0.2 mi	150 m (500 ft)	0.6 km (0.4 mi)	1.6 km (1.0 mi)

"+" means distance can be larger in certain atmospheric conditions

TABLE 1

TABLE 1 - INITIAL ISOLATION AND PROTECTIVE ACTION DISTANCES

		SMALL SPILLS (From a small package or small leak from a large package)				LARGE SPILLS (From a large package or from many small packages)				
ID No.	Guide No.	Name of Material	First ISOLATE in all Directions		Then PROTECT persons Downwind during		First ISOLATE in all Directions		Then PROTECT persons Downwind during	
			Meters (Feet)	Kilometers (Miles)	DAY Kilometers (Miles)	NIGHT Kilometers (Miles)	Meters (Feet)	Kilometers (Miles)	DAY Kilometers (Miles)	NIGHT Kilometers (Miles)
3355	119	Insecticide gas, toxic, flammable, n.o.s. (Inhalation Hazard Zone D)	30 m (100 ft)	0.1 km (0.1 mi)	0.3 km (0.2 mi)	0.1 km (0.1 mi)	0.3 km (0.2 mi)	150 m (500 ft)	0.6 km (0.4 mi)	1.6 km (1.0 mi)
3361	156	Chlorosilanes, poisonous, corrosive, n.o.s.								
3361	156	(when spilled in water) Chlorosilanes, toxic, corrosive, n.o.s. (when spilled in water)	30 m (100 ft)	0.1 km (0.1 mi)	0.2 km (0.1 mi)	0.1 km (0.1 mi)	0.2 km (0.1 mi)	60 m (200 ft)	0.5 km (0.3 mi)	1.6 km (1.0 mi)
3362	155	Chlorosilanes, poisonous, corrosive, flammable, n.o.s.								
3362	155	(when spilled in water) Chlorosilanes, toxic, corrosive, flammable, n.o.s. (when spilled in water)	30 m (100 ft)	0.1 km (0.1 mi)	0.2 km (0.1 mi)	0.1 km (0.1 mi)	0.2 km (0.1 mi)	60 m (200 ft)	0.5 km (0.3 mi)	1.6 km (1.0 mi)
3381	151	Poisonous by inhalation liquid, n.o.s.								
3381	151	(Inhalation Hazard Zone A) Toxic by inhalation liquid, n.o.s. (Inhalation Hazard Zone A)	60 m (200 ft)	0.6 km (0.4 mi)	1.8 km (1.1 mi)	0.6 km (0.4 mi)	1.8 km (1.1 mi)	200 m (600 ft)	2.3 km (1.4 mi)	4.2 km (2.6 mi)
3382	151	Poisonous by inhalation liquid, n.o.s.								
3382	151	(Inhalation Hazard Zone B) Toxic by inhalation liquid, n.o.s. (Inhalation Hazard Zone B)	30 m (100 ft)	0.1 km (0.1 mi)	0.2 km (0.1 mi)	0.1 km (0.1 mi)	0.2 km (0.1 mi)	60 m (200 ft)	0.5 km (0.3 mi)	0.8 km (0.5 mi)

3383	131	Poisonous by inhalation liquid, flammable, n.o.s. (Inhalation Hazard Zone A)	60 m (200 ft)	0.5 km (0.3 mi)	1.5 km (1.0 mi)	300 m (1000 ft)	3.4 km (2.1 mi)	5.7 km (3.6 mi)
3383	131	Toxic by inhalation liquid, flammable, n.o.s. (Inhalation Hazard Zone A)	60 m (200 ft)	0.5 km (0.3 mi)	1.5 km (1.0 mi)	300 m (1000 ft)	3.4 km (2.1 mi)	5.7 km (3.6 mi)
3384	131	Poisonous by inhalation liquid, flammable, n.o.s. (Inhalation Hazard Zone B)	30 m (100 ft)	0.2 km (0.1 mi)	0.3 km (0.2 mi)	60 m (200 ft)	0.6 km (0.4 mi)	0.9 km (0.6 mi)
3384	131	Toxic by inhalation liquid, flammable, n.o.s. (Inhalation Hazard Zone B)	30 m (100 ft)	0.2 km (0.1 mi)	0.3 km (0.2 mi)	60 m (200 ft)	0.6 km (0.4 mi)	0.9 km (0.6 mi)
3385	139	Poisonous by inhalation liquid, water-reactive, n.o.s. (Inhalation Hazard Zone A)	60 m (200 ft)	0.6 km (0.4 mi)	1.8 km (1.1 mi)	200 m (600 ft)	2.3 km (1.4 mi)	4.2 km (2.6 mi)
3385	139	Toxic by inhalation liquid, water-reactive, n.o.s. (Inhalation Hazard Zone A)	60 m (200 ft)	0.6 km (0.4 mi)	1.8 km (1.1 mi)	200 m (600 ft)	2.3 km (1.4 mi)	4.2 km (2.6 mi)
3386	139	Poisonous by inhalation liquid, water-reactive, n.o.s. (Inhalation Hazard Zone B)	30 m (100 ft)	0.1 km (0.1 mi)	0.2 km (0.1 mi)	60 m (200 ft)	0.5 km (0.3 mi)	0.8 km (0.5 mi)
3386	139	Toxic by inhalation liquid, water-reactive, n.o.s. (Inhalation Hazard Zone B)	30 m (100 ft)	0.1 km (0.1 mi)	0.2 km (0.1 mi)	60 m (200 ft)	0.5 km (0.3 mi)	0.8 km (0.5 mi)
3387	142	Poisonous by inhalation liquid, oxidizing, n.o.s. (Inhalation Hazard Zone A)	60 m (200 ft)	0.5 km (0.3 mi)	1.5 km (1.0 mi)	300 m (1000 ft)	3.4 km (2.1 mi)	5.7 km (3.6 mi)
3387	142	Toxic by inhalation liquid, oxidizing, n.o.s. (Inhalation Hazard Zone A)	60 m (200 ft)	0.5 km (0.3 mi)	1.5 km (1.0 mi)	300 m (1000 ft)	3.4 km (2.1 mi)	5.7 km (3.6 mi)

"+" means distance can be larger in certain atmospheric conditions

TABLE 1

TABLE 1 - INITIAL ISOLATION AND PROTECTIVE ACTION DISTANCES

ID No.	Guide No.	Name of Material	SMALL SPILLS (From a small package or small leak from a large package)				LARGE SPILLS (From a large package or from many small packages)			
			First ISOLATE in all Directions		Then PROTECT persons Downwind during		First ISOLATE in all Directions		Then PROTECT persons Downwind during	
			Meters (Feet)	Kilometers (Miles)	DAY Kilometers (Miles)	NIGHT Kilometers (Miles)	Meters (Feet)	Kilometers (Miles)	DAY Kilometers (Miles)	NIGHT Kilometers (Miles)
3388	142	Poisonous by inhalation liquid, oxidizing, n.o.s. (Inhalation Hazard Zone B)	30 m (100 ft)	0.1 km (0.1 mi)	0.1 km (0.1 mi)	0.1 km (0.1 mi)	150 m (500 ft)	0.3 km (0.2 mi)	0.5 km (0.3 mi)	
3388	142	Toxic by inhalation liquid, oxidizing, n.o.s. (Inhalation Hazard Zone B)	30 m (100 ft)	0.1 km (0.1 mi)	0.1 km (0.1 mi)	0.1 km (0.1 mi)	150 m (500 ft)	0.3 km (0.2 mi)	0.5 km (0.3 mi)	
3389	154	Poisonous by inhalation liquid, corrosive, n.o.s. (Inhalation Hazard Zone A)	100 m (300 ft)	0.3 km (0.2 mi)	0.7 km (0.5 mi)	0.5 mi)	800 m (2500 ft)	1.7 km (1.1 mi)	2.8 km (1.8 mi)	
3389	154	Toxic by inhalation liquid, corrosive, n.o.s. (Inhalation Hazard Zone A)	100 m (300 ft)	0.3 km (0.2 mi)	0.7 km (0.5 mi)	0.5 mi)	800 m (2500 ft)	1.7 km (1.1 mi)	2.8 km (1.8 mi)	
3390	154	Poisonous by inhalation liquid, corrosive, n.o.s. (Inhalation Hazard Zone B)	30 m (100 ft)	0.2 km (0.1 mi)	0.2 km (0.1 mi)	0.1 mi)	60 m (200 ft)	0.5 km (0.3 mi)	0.6 km (0.4 mi)	
3390	154	Toxic by inhalation liquid, corrosive, n.o.s. (Inhalation Hazard Zone B)	30 m (100 ft)	0.2 km (0.1 mi)	0.2 km (0.1 mi)	0.1 mi)	60 m (200 ft)	0.5 km (0.3 mi)	0.6 km (0.4 mi)	
3456	157	Nitrosylsulfuric acid, solid (when spilled in water)	30 m (100 ft)	0.1 km (0.1 mi)	0.4 km (0.3 mi)	0.3 mi)	200 m (600 ft)	0.7 km (0.4 mi)	2.3 km (1.5 mi)	
3456	157	Nitrosylsulfuric acid, solid (when spilled in water)	30 m (100 ft)	0.1 km (0.1 mi)	0.4 km (0.3 mi)	0.3 mi)	200 m (600 ft)	0.7 km (0.4 mi)	2.3 km (1.5 mi)	

3488	131	Poisonous by inhalation liquid, flammable, corrosive, n.o.s. (Inhalation Hazard Zone A)	60 m (200 ft)	0.5 km (0.3 mi)	1.5 km (1.0 mi)	300 m (1000 ft)	3.4 km (2.1 mi)	5.7 km (3.6 mi)
3488	131	Toxic by inhalation liquid, flammable, corrosive, n.o.s. (Inhalation Hazard Zone A)	60 m (200 ft)	0.5 km (0.3 mi)	1.5 km (1.0 mi)	300 m (1000 ft)	3.4 km (2.1 mi)	5.7 km (3.6 mi)
3489	131	Poisonous by inhalation liquid, flammable, corrosive, n.o.s. (Inhalation Hazard Zone B)	30 m (100 ft)	0.2 km (0.1 mi)	0.3 km (0.2 mi)	60 m (200 ft)	0.6 km (0.4 mi)	0.9 km (0.6 mi)
3489	131	Toxic by inhalation liquid, flammable, corrosive, n.o.s. (Inhalation Hazard Zone B)	30 m (100 ft)	0.2 km (0.1 mi)	0.3 km (0.2 mi)	60 m (200 ft)	0.6 km (0.4 mi)	0.9 km (0.6 mi)
3490	155	Poisonous by inhalation liquid, water-reactive, flammable, n.o.s. (Inhalation Hazard Zone A)	60 m (200 ft)	0.5 km (0.3 mi)	1.5 km (1.0 mi)	300 m (1000 ft)	3.4 km (2.1 mi)	5.7 km (3.6 mi)
3490	155	Toxic by inhalation liquid, water-reactive, flammable, n.o.s. (Inhalation Hazard Zone A)	60 m (200 ft)	0.5 km (0.3 mi)	1.5 km (1.0 mi)	300 m (1000 ft)	3.4 km (2.1 mi)	5.7 km (3.6 mi)
3491	155	Poisonous by inhalation liquid, water-reactive, flammable, n.o.s. (Inhalation Hazard Zone B)	30 m (100 ft)	0.2 km (0.1 mi)	0.3 km (0.2 mi)	60 m (200 ft)	0.6 km (0.4 mi)	0.9 km (0.6 mi)
3491	155	Toxic by inhalation liquid, water-reactive, flammable, n.o.s. (Inhalation Hazard Zone B)	30 m (100 ft)	0.2 km (0.1 mi)	0.3 km (0.2 mi)	60 m (200 ft)	0.6 km (0.4 mi)	0.9 km (0.6 mi)

"+" means distance can be larger in certain atmospheric conditions

TABLE 1

TABLE 1 - INITIAL ISOLATION AND PROTECTIVE ACTION DISTANCES

ID No.	Guide No.	Name of Material	SMALL SPILLS (From a small package or small leak from a large package)				LARGE SPILLS (From a large package or from many small packages)			
			First ISOLATE in all Directions		Then PROTECT persons Downwind during		First ISOLATE in all Directions		Then PROTECT persons Downwind during	
			Meters (Feet)	Kilometers (Miles)	DAY Kilometers (Miles)	NIGHT Kilometers (Miles)	Meters (Feet)	Kilometers (Miles)	DAY Kilometers (Miles)	NIGHT Kilometers (Miles)
3492	131	Poisonous by inhalation liquid, corrosive, flammable, n.o.s. (Inhalation Hazard Zone A)	60 m (200 ft)	0.5 km (0.3 mi)	1.5 km (1.0 mi)	300 m (1000 ft)	3.4 km (2.1 mi)	5.7 km (3.6 mi)		
3492	131	Toxic by inhalation liquid, corrosive, flammable, n.o.s. (Inhalation Hazard Zone A)	60 m (200 ft)	0.5 km (0.3 mi)	1.5 km (1.0 mi)	300 m (1000 ft)	3.4 km (2.1 mi)	5.7 km (3.6 mi)		
3493	131	Poisonous by inhalation liquid, corrosive, flammable, n.o.s. (Inhalation Hazard Zone B)	30 m (100 ft)	0.2 km (0.1 mi)	0.3 km (0.2 mi)	60 m (200 ft)	0.6 km (0.4 mi)	0.9 km (0.6 mi)		
3493	131	Toxic by inhalation liquid, corrosive, flammable, n.o.s. (Inhalation Hazard Zone B)	30 m (100 ft)	0.2 km (0.1 mi)	0.3 km (0.2 mi)	60 m (200 ft)	0.6 km (0.4 mi)	0.9 km (0.6 mi)		
3494	131	Petroleum sour crude oil, flammable, poisonous	30 m (100 ft)	0.1 km (0.1 mi)	0.2 km (0.1 mi)	60 m (200 ft)	0.5 km (0.3 mi)	0.8 km (0.5 mi)		
3494	131	Petroleum sour crude oil, flammable, toxic	30 m (100 ft)	0.1 km (0.1 mi)	0.2 km (0.1 mi)	60 m (200 ft)	0.5 km (0.3 mi)	0.8 km (0.5 mi)		
3507	166	Uranium hexafluoride, radioactive material, excepted package, less than 0.1 kg per package, non-fissile or fissile-excepted (when spilled in water)	30 m (100 ft)	0.1 km (0.1 mi)	0.1 km (0.1 mi)	30 m (100 ft)	0.1 km (0.1 mi)	0.1 km (0.1 mi)		

3512	173	Adsorbed gas, poisonous, n.o.s.							
3512	173	Adsorbed gas, poisonous, n.o.s. (Inhalation Hazard Zone A)							
3512	173	Adsorbed gas, poisonous, n.o.s. (Inhalation Hazard Zone B)	30 m (100 ft)	0.1 km (0.1 mi)	0.1 km (0.1 mi)	30 m (100 ft)	0.1 km (0.1 mi)	0.1 km (0.1 mi)	0.1 km (0.1 mi)
3512	173	Adsorbed gas, poisonous, n.o.s. (Inhalation Hazard Zone C)							
3512	173	Adsorbed gas, poisonous, n.o.s. (Inhalation Hazard Zone D)							
3512	173	Adsorbed gas, toxic, n.o.s.							
3512	173	Adsorbed gas, toxic, n.o.s. (Inhalation Hazard Zone A)							
3512	173	Adsorbed gas, toxic, n.o.s. (Inhalation Hazard Zone B)	30 m (100 ft)	0.1 km (0.1 mi)	0.1 km (0.1 mi)	30 m (100 ft)	0.1 km (0.1 mi)	0.1 km (0.1 mi)	0.1 km (0.1 mi)
3512	173	Adsorbed gas, toxic, n.o.s. (Inhalation Hazard Zone C)							
3512	173	Adsorbed gas, toxic, n.o.s. (Inhalation Hazard Zone D)							
3514	173	Adsorbed gas, poisonous, flammable, n.o.s.							
3514	173	Adsorbed gas, poisonous, flammable, n.o.s. (Inhalation Hazard Zone A)							
3514	173	Adsorbed gas, poisonous, flammable, n.o.s. (Inhalation Hazard Zone B)	30 m (100 ft)	0.1 km (0.1 mi)	0.1 km (0.1 mi)	30 m (100 ft)	0.1 km (0.1 mi)	0.1 km (0.1 mi)	0.1 km (0.1 mi)
3514	173	Adsorbed gas, poisonous, flammable, n.o.s. (Inhalation Hazard Zone C)							
3514	173	Adsorbed gas, poisonous, flammable, n.o.s. (Inhalation Hazard Zone D)							

"+" means distance can be larger in certain atmospheric conditions

TABLE 1

TABLE 1 - INITIAL ISOLATION AND PROTECTIVE ACTION DISTANCES

ID No.	Guide No.	Name of Material	SMALL SPILLS (From a small package or small leak from a large package)		LARGE SPILLS (From a large package or from many small packages)			
			First ISOLATE in all Directions Meters (Feet)	Then PROTECT persons Downwind during		First ISOLATE in all Directions Meters (Feet)	Then PROTECT persons Downwind during	
				DAY Kilometers (Miles)	NIGHT Kilometers (Miles)		DAY Kilometers (Miles)	NIGHT Kilometers (Miles)
3514	173	Adsorbed gas, toxic, flammable, n.o.s.						
3514	173	Adsorbed gas, toxic, flammable, n.o.s. (Inhalation Hazard Zone A)						
3514	173	Adsorbed gas, toxic, flammable, n.o.s. (Inhalation Hazard Zone B)	30 m (100 ft)	0.1 km (0.1 mi)	30 m (100 ft)	0.1 km (0.1 mi)	0.1 km (0.1 mi)	0.1 km (0.1 mi)
3514	173	Adsorbed gas, toxic, flammable, n.o.s. (Inhalation Hazard Zone C)						
3514	173	Adsorbed gas, toxic, flammable, n.o.s. (Inhalation Hazard Zone D)						
3515	173	Adsorbed gas, poisonous, oxidizing, n.o.s.						
3515	173	Adsorbed gas, poisonous, oxidizing, n.o.s. (Inhalation Hazard Zone A)						
3515	173	Adsorbed gas, poisonous, oxidizing, n.o.s. (Inhalation Hazard Zone B)	30 m (100 ft)	0.1 km (0.1 mi)	30 m (100 ft)	0.1 km (0.1 mi)	0.1 km (0.1 mi)	0.1 km (0.1 mi)
3515	173	Adsorbed gas, poisonous, oxidizing, n.o.s. (Inhalation Hazard Zone C)						
3515	173	Adsorbed gas, poisonous, oxidizing, n.o.s. (Inhalation Hazard Zone D)						

3515	173	Adsorbed gas, toxic, oxidizing, n.o.s.	30 m (100 ft)	0.1 km (0.1 mi)	30 m (100 ft)	0.1 km (0.1 mi)	0.1 km (0.1 mi)	0.1 km (0.1 mi)
3515	173	Adsorbed gas, toxic, oxidizing, n.o.s. (Inhalation Hazard Zone A)						
3515	173	Adsorbed gas, toxic, oxidizing, n.o.s. (Inhalation Hazard Zone B)						
3515	173	Adsorbed gas, toxic, oxidizing, n.o.s. (Inhalation Hazard Zone C)						
3515	173	Adsorbed gas, toxic, oxidizing, n.o.s. (Inhalation Hazard Zone D)						
3516	173	Adsorbed gas, poisonous, corrosive, n.o.s.						
3516	173	Adsorbed gas, poisonous, corrosive, n.o.s. (Inhalation Hazard Zone A)						
3516	173	Adsorbed gas, poisonous, corrosive, n.o.s. (Inhalation Hazard Zone B)	30 m (100 ft)	0.1 km (0.1 mi)	30 m (100 ft)	0.1 km (0.1 mi)	0.1 km (0.1 mi)	0.1 km (0.1 mi)
3516	173	Adsorbed gas, poisonous, corrosive, n.o.s. (Inhalation Hazard Zone C)						
3516	173	Adsorbed gas, poisonous, corrosive, n.o.s. (Inhalation Hazard Zone D)						

"+" means distance can be larger in certain atmospheric conditions

TABLE 1

TABLE 1 - INITIAL ISOLATION AND PROTECTIVE ACTION DISTANCES

ID No.	Guide No.	Name of Material	SMALL SPILLS (From a small package or small leak from a large package)			LARGE SPILLS (From a large package or from many small packages)		
			First ISOLATE in all Directions Meters (Feet)	Then PROTECT persons Downwind during		First ISOLATE in all Directions Meters (Feet)	Then PROTECT persons Downwind during	
				DAY Kilometers (Miles)	NIGHT Kilometers (Miles)		DAY Kilometers (Miles)	NIGHT Kilometers (Miles)
3516	173	Adsorbed gas, toxic, corrosive, n.o.s.						
3516	173	Adsorbed gas, toxic, corrosive, n.o.s. (Inhalation Hazard Zone A)						
3516	173	Adsorbed gas, toxic, corrosive, n.o.s. (Inhalation Hazard Zone B)	30 m (100 ft)	0.1 km (0.1 mi)	0.1 km (0.1 mi)	30 m (100 ft)	0.1 km (0.1 mi)	0.1 km (0.1 mi)
3516	173	Adsorbed gas, toxic, corrosive, n.o.s. (Inhalation Hazard Zone C)						
3516	173	Adsorbed gas, toxic, corrosive, n.o.s. (Inhalation Hazard Zone D)						
3517	173	Adsorbed gas, poisonous, flammable, corrosive, n.o.s.						
3517	173	Adsorbed gas, poisonous, flammable, corrosive, n.o.s. (Inhalation Hazard Zone A)						
3517	173	Adsorbed gas, poisonous, flammable, corrosive, n.o.s. (Inhalation Hazard Zone B)	30 m (100 ft)	0.1 km (0.1 mi)	0.1 km (0.1 mi)	30 m (100 ft)	0.1 km (0.1 mi)	0.1 km (0.1 mi)
3517	173	Adsorbed gas, poisonous, flammable, corrosive, n.o.s. (Inhalation Hazard Zone C)						
3517	173	Adsorbed gas, poisonous, flammable, corrosive, n.o.s. (Inhalation Hazard Zone D)						

3517	173	Adsorbed gas, toxic, flammable, corrosive, n.o.s.	30 m (100 ft)	0.1 km (0.1 mi)	0.1 km (0.1 mi)	0.1 km (0.1 mi)	0.1 km (0.1 mi)
3517	173	Adsorbed gas, toxic, flammable, corrosive, n.o.s. (Inhalation Hazard Zone A)					
3517	173	Adsorbed gas, toxic, flammable, corrosive, n.o.s. (Inhalation Hazard Zone B)	30 m (100 ft)	0.1 km (0.1 mi)	0.1 km (0.1 mi)	0.1 km (0.1 mi)	0.1 km (0.1 mi)
3517	173	Adsorbed gas, toxic, flammable, corrosive, n.o.s. (Inhalation Hazard Zone C)					
3517	173	Adsorbed gas, toxic, flammable, corrosive, n.o.s. (Inhalation Hazard Zone D)					
3518	173	Adsorbed gas, poisonous, oxidizing, corrosive, n.o.s.					
3518	173	Adsorbed gas, poisonous, oxidizing, corrosive, n.o.s. (Inhalation Hazard Zone A)					
3518	173	Adsorbed gas, poisonous, oxidizing, corrosive, n.o.s. (Inhalation Hazard Zone B)	30 m (100 ft)	0.1 km (0.1 mi)	0.1 km (0.1 mi)	0.1 km (0.1 mi)	0.1 km (0.1 mi)
3518	173	Adsorbed gas, poisonous, oxidizing, corrosive, n.o.s. (Inhalation Hazard Zone C)					
3518	173	Adsorbed gas, poisonous, oxidizing, corrosive, n.o.s. (Inhalation Hazard Zone D)					

"+" means distance can be larger in certain atmospheric conditions

TABLE 1

TABLE 1 - INITIAL ISOLATION AND PROTECTIVE ACTION DISTANCES

ID No.	Guide No.	Name of Material	SMALL SPILLS (From a small package or small leak from a large package)		LARGE SPILLS (From a large package or from many small packages)			
			First ISOLATE in all Directions Meters (Feet)	Then PROTECT persons Downwind during		First ISOLATE in all Directions Meters (Feet)	Then PROTECT persons Downwind during	
				DAY Kilometers (Miles)	NIGHT Kilometers (Miles)		DAY Kilometers (Miles)	NIGHT Kilometers (Miles)
3518	173	Adsorbed gas, toxic, oxidizing, corrosive, n.o.s.						
3518	173	Adsorbed gas, toxic, oxidizing, corrosive, n.o.s. (Inhalation Hazard Zone A)						
3518	173	Adsorbed gas, toxic, oxidizing, corrosive, n.o.s. (Inhalation Hazard Zone B)	30 m (100 ft)	0.1 km (0.1 mi)	0.1 km (0.1 mi)	30 m (100 ft)	0.1 km (0.1 mi)	0.1 km (0.1 mi)
3518	173	Adsorbed gas, toxic, oxidizing, corrosive, n.o.s. (Inhalation Hazard Zone C)						
3518	173	Adsorbed gas, toxic, oxidizing, corrosive, n.o.s. (Inhalation Hazard Zone D)						
3519	173	Boron trifluoride, adsorbed	30 m (100 ft)	0.1 km (0.1 mi)	0.1 km (0.1 mi)	30 m (100 ft)	0.1 km (0.1 mi)	0.1 km (0.1 mi)
3520	173	Chlorine, adsorbed	30 m (100 ft)	0.1 km (0.1 mi)	0.1 km (0.1 mi)	30 m (100 ft)	0.1 km (0.1 mi)	0.1 km (0.1 mi)
3521	173	Silicon tetrafluoride, adsorbed	30 m (100 ft)	0.1 km (0.1 mi)	0.1 km (0.1 mi)	30 m (100 ft)	0.1 km (0.1 mi)	0.1 km (0.1 mi)
3522	173	Arsine, adsorbed	30 m (100 ft)	0.1 km (0.1 mi)	0.1 km (0.1 mi)	30 m (100 ft)	0.1 km (0.1 mi)	0.1 km (0.1 mi)
3523	173	Germane, adsorbed	30 m (100 ft)	0.1 km (0.1 mi)	0.1 km (0.1 mi)	30 m (100 ft)	0.1 km (0.1 mi)	0.1 km (0.1 mi)
3524	173	Phosphorus pentaffluoride, adsorbed	30 m (100 ft)	0.1 km (0.1 mi)	0.1 km (0.1 mi)	30 m (100 ft)	0.1 km (0.1 mi)	0.1 km (0.1 mi)
3525	173	Phosphine, adsorbed	30 m (100 ft)	0.1 km (0.1 mi)	0.1 km (0.1 mi)	30 m (100 ft)	0.1 km (0.1 mi)	0.1 km (0.1 mi)
3526	173	Hydrogen selenide, adsorbed	30 m (100 ft)	0.1 km (0.1 mi)	0.1 km (0.1 mi)	30 m (100 ft)	0.1 km (0.1 mi)	0.1 km (0.1 mi)

3539	123	Articles containing toxic gas, n.o.s.	30 m (100 ft)	0.3 km (0.2 mi)	1.1 km (0.7 mi)	300 m (1000 ft)	1.4 km (0.9 mi)	3.7 km (2.3 mi)
9191	143	Chlorine dioxide, hydrate, frozen (when spilled in water)	30 m (100 ft)	0.1 km (0.1 mi)	0.1 km (0.1 mi)	30 m (100 ft)	0.2 km (0.1 mi)	0.5 km (0.3 mi)
9202	168	Carbon monoxide, refrigerated liquid (cryogenic liquid)	30 m (100 ft)	0.1 km (0.1 mi)	0.2 km (0.1 mi)	200 m (600 ft)	1.2 km (0.7 mi)	3.9 km (2.4 mi)
9206	137	Methyl phosphonic dichloride	30 m (100 ft)	0.2 km (0.1 mi)	0.2 km (0.1 mi)	60 m (200 ft)	0.5 km (0.3 mi)	0.6 km (0.4 mi)
9263	156	Chloropivaloyl chloride	30 m (100 ft)	0.1 km (0.1 mi)	0.1 km (0.1 mi)	30 m (100 ft)	0.2 km (0.2 mi)	0.3 km (0.2 mi)
9264	151	3,5-Dichloro-2,4,6-trifluoropyridine	30 m (100 ft)	0.1 km (0.1 mi)	0.1 km (0.1 mi)	30 m (100 ft)	0.2 km (0.2 mi)	0.3 km (0.2 mi)
9269	132	Trimethoxysilane	30 m (100 ft)	0.2 km (0.2 mi)	0.7 km (0.4 mi)	150 m (500 ft)	1.4 km (0.9 mi)	2.4 km (1.5 mi)

See Next Page for Table 2 - Water-Reactive Materials Which Produce Toxic Gases

"+" means distance can be larger in certain atmospheric conditions

TABLE 1

HOW TO USE TABLE 2 – WATER-REACTIVE MATERIALS WHICH PRODUCE TOXIC GASES

Table 2 lists materials which produce large amounts of Toxic Inhalation Hazard (TIH) (PIH in the US) gases when spilled in water, and identifies the TIH gases produced.

The materials are listed by order of ID number.

These water-reactive materials are easily identified in Table 1 as their names are immediately followed by **(when spilled in water)**.

Note 1: The TIH gases indicated in Table 2 are for information purposes only. In Table 1, the initial isolation and protective action distances have already taken into consideration the TIH gases produced.

For example: Table 2 indicates that UN1689 sodium cyanide, when spilled in water, will generate hydrogen cyanide gas (HCN). In Table 1, you must refer to the distances for sodium cyanide and not the distances for hydrogen cyanide gas.

Note 2: Some water-reactive materials are also TIH materials themselves (e.g., UN1746 (Bromine trifluoride), UN1836 (Thionyl chloride)). In these instances, two entries are provided in Table 1 for land-based and water-based spills. If a water-reactive material only has one entry in Table 1 for **(when spilled in water)**, and the product is **NOT** spilled in water, Tables 1 and 2 do **NOT** apply. Refer only to the appropriate Orange Guide.

Note 3: Materials classified as a Division 4.3 are substances that, on contact with water, are liable to become spontaneously **FLAMMABLE** or give off **FLAMMABLE** or sometimes **TOXIC** gases in dangerous quantities. For the purpose of this table, water-reactive materials are materials that generate substantial quantities of **TOXIC** gases rapidly after a spill into water; therefore, a material classified as a Division 4.3 will not always be included in Table 2.

TABLE 2 - WATER-REACTIVE MATERIALS WHICH PRODUCE TOXIC GASES

**Materials Which Produce Large Amounts of Toxic-by-Inhalation (TIH)
(PIH in the US) Gas(es) When Spilled in Water**

ID No.	Guide No.	Name of Material	TIH Gas(es) Produced
1162	155	Dimethyldichlorosilane	HCl
1183	139	Ethyldichlorosilane	HCl
1196	155	Ethyltrichlorosilane	HCl
1242	139	Methyldichlorosilane	HCl
1250	155	Methyltrichlorosilane	HCl
1295	139	Trichlorosilane	HCl
1298	155	Trimethylchlorosilane	HCl
1305	155P	Vinyltrichlorosilane	HCl
1340	139	Phosphorus pentasulfide, free from yellow and white phosphorus	H ₂ S
1340	139	Phosphorus pentasulphide, free from yellow and white phosphorus	H ₂ S
1360	139	Calcium phosphide	PH ₃
1384	135	Sodium dithionite	H ₂ S SO ₂
1384	135	Sodium hydrosulfite	H ₂ S SO ₂
1384	135	Sodium hydrosulphite	H ₂ S SO ₂
1390	139	Alkali metal amides	NH ₃
1397	139	Aluminum phosphide	PH ₃
1419	139	Magnesium aluminum phosphide	PH ₃
1432	139	Sodium phosphide	PH ₃
1541	156	Acetone cyanohydrin, stabilized	HCN
1680	157	Potassium cyanide, solid	HCN
1689	157	Sodium cyanide, solid	HCN
1716	156	Acetyl bromide	HBr
1717	155	Acetyl chloride	HCl
1724	155	Allyltrichlorosilane, stabilized	HCl

Chemical Symbols for TIH (PIH in the US) Gases:

Br ₂	Bromine	HF	Hydrogen fluoride	NO ₂	Nitrogen dioxide
Cl ₂	Chlorine	HI	Hydrogen iodide	PH ₃	Phosphine
HBr	Hydrogen bromide	H ₂ S	Hydrogen sulfide	SO ₂	Sulfur dioxide
HCl	Hydrogen chloride	H ₂ S	Hydrogen sulphide	SO ₂	Sulphur dioxide
HCN	Hydrogen cyanide	NH ₃	Ammonia		

TABLE 2

TABLE2 - WATER-REACTIVE MATERIALS WHICH PRODUCE TOXIC GASES

**Materials Which Produce Large Amounts of Toxic-by-Inhalation (TIH)
(PIH in the US) Gas(es) When Spilled in Water**

ID No.	Guide No.	Name of Material	TIH Gas(es) Produced
1725	137	Aluminum bromide, anhydrous	HBr
1726	137	Aluminum chloride, anhydrous	HCl
1728	156	Amyltrimchlorosilane	HCl
1732	157	Antimony pentafluoride	HF
1741	125	Boron trichloride	HCl
1745	144	Bromine pentafluoride	HF Br ₂
1746	144	Bromine trifluoride	HF Br ₂
1747	155	Butyltrimchlorosilane	HCl
1752	156	Chloroacetyl chloride	HCl
1753	156	Chlorophenyltrimchlorosilane	HCl
1754	137	Chlorosulfonic acid (with or without sulfur trioxide)	HCl
1754	137	Chlorosulphonic acid (with or without sulphur trioxide)	HCl
1758	137	Chromium oxychloride	HCl
1762	156	Cyclohexenyltrimchlorosilane	HCl
1763	156	Cyclohexyltrimchlorosilane	HCl
1765	156	Dichloroacetyl chloride	HCl
1766	156	Dichlorophenyltrimchlorosilane	HCl
1767	155	Diethyldichlorosilane	HCl
1769	156	Dipenyldichlorosilane	HCl
1771	156	Dodecyltrimchlorosilane	HCl
1777	137	Fluorosulfonic acid	HF
1777	137	Fluorosulphonic acid	HF
1781	156	Hexadecyltrimchlorosilane	HCl
1784	156	Hexyltrimchlorosilane	HCl

Chemical Symbols for TIH (PIH in the US) Gases:

Br ₂	Bromine	HF	Hydrogen fluoride	NO ₂	Nitrogen dioxide
Cl ₂	Chlorine	HI	Hydrogen iodide	PH ₃	Phosphine
HBr	Hydrogen bromide	H ₂ S	Hydrogen sulfide	SO ₂	Sulfur dioxide
HCl	Hydrogen chloride	H ₂ S	Hydrogen sulphide	SO ₂	Sulphur dioxide
HCN	Hydrogen cyanide	NH ₃	Ammonia		

TABLE 2 - WATER-REACTIVE MATERIALS WHICH PRODUCE TOXIC GASES

**Materials Which Produce Large Amounts of Toxic-by-Inhalation (TIH)
(PIH in the US) Gas(es) When Spilled in Water**

ID No.	Guide No.	Name of Material	TIH Gas(es) Produced
1799	156	Nonyltrichlorosilane	HCl
1800	156	Octadecyltrichlorosilane	HCl
1801	156	Octyltrichlorosilane	HCl
1804	156	Phenyltrichlorosilane	HCl
1806	137	Phosphorus pentachloride	HCl
1808	137	Phosphorus tribromide	HBr
1809	137	Phosphorus trichloride	HCl
1810	137	Phosphorus oxychloride	HCl
1815	155	Propionyl chloride	HCl
1816	155	Propyltrichlorosilane	HCl
1818	157	Silicon tetrachloride	HCl
1828	137	Sulfur chlorides	HCl SO ₂ H ₂ S
1828	137	Sulphur chlorides	HCl SO ₂ H ₂ S
1834	137	Sulfuryl chloride	HCl
1834	137	Sulphuryl chloride	HCl
1836	137	Thionyl chloride	HCl SO ₂
1838	137	Titanium tetrachloride	HCl
1898	156	Acetyl iodide	HI
1923	135	Calcium dithionite	H ₂ S SO ₂
1923	135	Calcium hydrosulfite	H ₂ S SO ₂
1923	135	Calcium hydrosulphite	H ₂ S SO ₂
1929	135	Potassium dithionite	H ₂ S SO ₂
1929	135	Potassium hydrosulfite	H ₂ S SO ₂
1929	135	Potassium hydrosulphite	H ₂ S SO ₂

TABLE 2

Chemical Symbols for TIH (PIH in the US) Gases:

Br ₂	Bromine	HF	Hydrogen fluoride	NO ₂	Nitrogen dioxide
Cl ₂	Chlorine	HI	Hydrogen iodide	PH ₃	Phosphine
HBr	Hydrogen bromide	H ₂ S	Hydrogen sulfide	SO ₂	Sulfur dioxide
HCl	Hydrogen chloride	H ₂ S	Hydrogen sulphide	SO ₂	Sulphur dioxide
HCN	Hydrogen cyanide	NH ₃	Ammonia		

TABLE2 - WATER-REACTIVE MATERIALS WHICH PRODUCE TOXIC GASES

**Materials Which Produce Large Amounts of Toxic-by-Inhalation (TIH)
(PIH in the US) Gas(es) When Spilled in Water**

ID No.	Guide No.	Name of Material	TIH Gas(es) Produced
1931	171	Zinc dithionite	H ₂ S SO ₂
1931	171	Zinc hydrosulfite	H ₂ S SO ₂
1931	171	Zinc hydrosulphite	H ₂ S SO ₂
2004	135	Magnesium diamide	NH ₃
2011	139	Magnesium phosphide	PH ₃
2012	139	Potassium phosphide	PH ₃
2013	139	Strontium phosphide	PH ₃
2308	157	Nitrosylsulfuric acid, liquid	NO ₂
2308	157	Nitrosylsulphuric acid, liquid	NO ₂
2353	155	Butyryl chloride	HCl
2395	155	Isobutyryl chloride	HCl
2434	156	Dibenzylchlorosilane	HCl
2435	156	Ethylphenyldichlorosilane	HCl
2437	156	Methylphenyldichlorosilane	HCl
2495	144	Iodine pentafluoride	HF
2691	137	Phosphorus pentabromide	HBr
2692	157	Boron tribromide	HBr
2806	139	Lithium nitride	NH ₃
2965	139	Boron trifluoride dimethyl etherate	HF
2977	166	Radioactive material, uranium hexafluoride, fissile	HF
2977	166	Uranium hexafluoride, radioactive material, fissile	HF
2978	166	Radioactive material, uranium hexafluoride, non fissile or fissile-excepted	HF

Chemical Symbols for TIH (PIH in the US) Gases:

Br ₂	Bromine	HF	Hydrogen fluoride	NO ₂	Nitrogen dioxide
Cl ₂	Chlorine	HI	Hydrogen iodide	PH ₃	Phosphine
HBr	Hydrogen bromide	H ₂ S	Hydrogen sulfide	SO ₂	Sulfur dioxide
HCl	Hydrogen chloride	H ₂ S	Hydrogen sulphide	SO ₂	Sulphur dioxide
HCN	Hydrogen cyanide	NH ₃	Ammonia		

TABLE 2 - WATER-REACTIVE MATERIALS WHICH PRODUCE TOXIC GASES

**Materials Which Produce Large Amounts of Toxic-by-Inhalation (TIH)
(PIH in the US) Gas(es) When Spilled in Water**

ID No.	Guide No.	Name of Material	TIH Gas(es) Produced
2978	166	Uranium hexafluoride, radioactive material, non fissile or fissile-excepted	HF
2985	155	Chlorosilanes, flammable, corrosive, n.o.s.	HCl
2986	155	Chlorosilanes, corrosive, flammable, n.o.s.	HCl
2987	156	Chlorosilanes, corrosive, n.o.s.	HCl
2988	139	Chlorosilanes, water-reactive, flammable, corrosive, n.o.s.	HCl
3048	157	Aluminum phosphide pesticide	PH ₃
3361	156	Chlorosilanes, poisonous, corrosive, n.o.s.	HCl
3361	156	Chlorosilanes, toxic, corrosive, n.o.s.	HCl
3362	155	Chlorosilanes, poisonous, corrosive, flammable, n.o.s.	HCl
3362	155	Chlorosilanes, toxic, corrosive, flammable, n.o.s.	HCl
3456	157	Nitrosylsulfuric acid, solid	NO ₂
3456	157	Nitrosylsulphuric acid, solid	NO ₂
3507	166	Uranium hexafluoride, radioactive material, excepted package, less than 0.1 kg per package, non-fissile or fissile-excepted	HF
9191	143	Chlorine dioxide, hydrate, frozen	Cl ₂

TABLE 2

Chemical Symbols for TIH (PIH in the US) Gases:

Br ₂	Bromine	HF	Hydrogen fluoride	NO ₂	Nitrogen dioxide
Cl ₂	Chlorine	HI	Hydrogen iodide	PH ₃	Phosphine
HBr	Hydrogen bromide	H ₂ S	Hydrogen sulfide	SO ₂	Sulfur dioxide
HCl	Hydrogen chloride	H ₂ S	Hydrogen sulphide	SO ₂	Sulphur dioxide
HCN	Hydrogen cyanide	NH ₃	Ammonia		

HOW TO USE TABLE 3 – INITIAL ISOLATION AND PROTECTIVE ACTION DISTANCES FOR LARGE SPILLS FOR DIFFERENT QUANTITIES OF SIX COMMON TIH (PIH IN THE US) GASES

Table 3 lists Toxic Inhalation Hazard (TIH) materials that may be more commonly encountered.

The selected materials are:

- UN1005 - Ammonia, anhydrous
- UN1017 - Chlorine
- UN1040 - Ethylene oxide and UN1040 – Ethylene oxide with nitrogen
- UN1050 - Hydrogen chloride, anhydrous and UN2186 - Hydrogen chloride, refrigerated liquid
- UN1052 - Hydrogen fluoride, anhydrous
- UN1079 - Sulfur dioxide/Sulphur dioxide

The materials are presented in numerical order of ID number and provide Initial Isolation and Protective Action Distances **FOR LARGE SPILLS** (more than 208 liters or 55 US gallons) involving different container types (therefore different volume capacities, see below) for day time and night time situations and different wind speeds.

- Rail tank car: 80 000 kg (176 370 lbs.)
- Highway tank truck or trailer: 20 000 – 25 000 kg (44 092 – 55 116 lbs.)
- Agricultural nurse tank: 3785 L (1000 gallons)
- Small cylinder: 72 L (19 gallons)
- Ton cylinder: 757 - 1135 L (200 - 300 gallons)

Estimating Wind Speed from Environmental Clues

mph	km/h	Wind Description	Specifications
< 6	< 10	Low wind	Wind felt on face; leaves rustle; ordinary vane moved by wind
6 - 12	10 - 20	Moderate wind	Raises dust, loose paper; small branches are moved
> 12	> 20	High wind	Large branches in motion; whistling heard in telephone wires; umbrellas used with difficulty

(Data taken from the Beaufort Wind Scale has been reworked in order to create 3 categories of wind speed: Low, Moderate and High)

TABLE 3 - INITIAL ISOLATION AND PROTECTIVE ACTION DISTANCES FOR LARGE SPILLS FOR DIFFERENT QUANTITIES OF SIX COMMON TIH (PIH IN THE US) GASES

TRANSPORT CONTAINER	First ISOLATE in all Directions	Then PROTECT persons Downwind during					
		DAY			NIGHT		
		Low wind (< 6 mph = < 10 km/h)	Moderate wind (6-12 mph = 10 - 20 km/h)	High wind (> 12 mph = > 20 km/h)	Low wind (< 6 mph = < 10 km/h)	Moderate wind (6-12 mph = 10 - 20 km/h)	High wind (> 12 mph = > 20 km/h)
Meters (Feet)	Kilometers (Miles)		Kilometers (Miles)		Kilometers (Miles)		
UN1005 Ammonia, anhydrous / Anhydrous ammonia: Large Spills							
Rail tank car	300 (1000)	1.6 (1.0)	1.2 (0.8)	1.0 (0.6)	4.1 (2.6)	2.1 (1.3)	1.3 (0.8)
Highway tank truck or trailer	150 (500)	0.8 (0.5)	0.5 (0.3)	0.4 (0.3)	1.8 (1.1)	0.7 (0.4)	0.6 (0.4)
Agricultural nurse tank	60 (200)	0.5 (0.3)	0.3 (0.2)	0.3 (0.2)	1.4 (0.9)	0.3 (0.2)	0.3 (0.2)
Multiple small cylinders	30 (100)	0.3 (0.2)	0.2 (0.1)	0.1 (0.1)	0.7 (0.5)	0.3 (0.2)	0.2 (0.1)
UN1017 Chlorine: Large Spills							
Rail tank car	1000 (3000)	9.6 (6.0)	6.3 (3.9)	5.1 (3.2)	11.0+ (7.0+)	8.9 (5.6)	6.5 (4.1)
Highway tank truck or trailer	600 (2000)	5.6 (3.5)	3.3 (2.1)	2.5 (1.6)	6.4 (4.0)	4.7 (2.9)	3.8 (2.4)
Multiple ton cylinders	300 (1000)	1.9 (1.2)	1.3 (0.8)	1.0 (0.6)	3.5 (2.2)	2.3 (1.4)	1.3 (0.8)
Multiple small cylinders or single ton cylinder	150 (500)	1.3 (0.9)	0.7 (0.5)	0.5 (0.3)	2.4 (1.5)	1.2 (0.8)	0.6 (0.4)

TABLE 3

"+" means distance can be larger in certain atmospheric conditions

TABLE 3 - INITIAL ISOLATION AND PROTECTIVE ACTION DISTANCES FOR LARGE SPILLS FOR DIFFERENT QUANTITIES OF SIX COMMON TIH (PIH IN THE US) GASES

TRANSPORT CONTAINER	First ISOLATE in all Directions	Then PROTECT persons Downwind during					
		DAY			NIGHT		
		Low wind (< 6 mph = < 10 km/h)	Moderate wind (6-12 mph = 10 - 20 km/h)	High wind (> 12 mph = > 20 km/h)	Low wind (< 6 mph = < 10 km/h)	Moderate wind (6-12 mph = 10 - 20 km/h)	High wind (> 12 mph = > 20 km/h)
Meters (Feet)	Kilometers (Miles)	Kilometers (Miles)	Kilometers (Miles)	Kilometers (Miles)	Kilometers (Miles)		
UN1040 Ethylene oxide: Large Spills							
UN1040 Ethylene oxide with nitrogen: Large Spills							
Rail tank car	200 (600)	1.5 (1.0)	0.8 (0.5)	0.7 (0.4)	3.0 (1.8)	1.4 (0.9)	0.8 (0.5)
Highway tank truck or trailer	100 (300)	0.9 (0.6)	0.5 (0.3)	0.4 (0.3)	2.0 (1.3)	0.7 (0.4)	0.4 (0.3)
Multiple small cylinders or single ton cylinder	30 (100)	0.4 (0.3)	0.2 (0.1)	0.1 (0.1)	0.8 (0.5)	0.3 (0.2)	0.2 (0.1)
UN1050 Hydrogen chloride, anhydrous: Large Spills							
UN2186 Hydrogen chloride, refrigerated liquid: Large Spills							
Rail tank car	500 (1500)	3.7 (2.3)	2.0 (1.3)	1.7 (1.1)	9.7 (6.1)	3.3 (2.1)	2.2 (1.4)
Highway tank truck or trailer	200 (600)	1.5 (0.9)	0.8 (0.5)	0.6 (0.4)	3.7 (2.3)	1.5 (0.9)	0.8 (0.5)
Multiple ton cylinders	30 (100)	0.4 (0.3)	0.2 (0.1)	0.1 (0.1)	1.0 (0.6)	0.3 (0.2)	0.1 (0.1)
Multiple small cylinders or single ton cylinder	30 (100)	0.3 (0.2)	0.2 (0.1)	0.1 (0.1)	0.9 (0.6)	0.3 (0.2)	0.2 (0.1)

TABLE 3 - INITIAL ISOLATION AND PROTECTIVE ACTION DISTANCES FOR LARGE SPILLS FOR DIFFERENT QUANTITIES OF SIX COMMON TIH (PIH IN THE US) GASES

	First ISOLATE in all Directions	Then PROTECT persons Downwind during					
		DAY			NIGHT		
		Low wind (< 6 mph = < 10 km/h)	Moderate wind (6-12 mph = 10 - 20 km/h)	High wind (> 12 mph = > 20 km/h)	Low wind (< 6 mph = < 10 km/h)	Moderate wind (6-12 mph = 10 - 20 km/h)	High wind (> 12 mph = > 20 km/h)
Meters (Feet)	Kilometers (Miles)			Kilometers (Miles)			
TRANSPORT CONTAINER		UN1052 Hydrogen fluoride, anhydrous: Large Spills					
Rail tank car	500 (1500)	3.4 (2.1)	2.1 (1.3)	1.8 (1.1)	6.4 (4.0)	3.0 (1.9)	1.9 (1.2)
Highway tank truck or trailer	200 (700)	2.0 (1.2)	1.0 (0.7)	0.9 (0.6)	3.6 (2.3)	1.5 (1.0)	0.9 (0.6)
Multiple small cylinders or single ton cylinder	100 (300)	0.8 (0.5)	0.4 (0.2)	0.3 (0.2)	1.7 (1.1)	0.5 (0.3)	0.3 (0.2)
TRANSPORT CONTAINER		UN1079 Sulfur dioxide / Sulphur dioxide: Large Spills					
Rail tank car	1000 (3000)	11.0+ (7.0+)	11.0+ (7.0+)	6.9 (4.3)	11.0+ (7.0+)	11.0+ (7.0+)	9.6 (6.0)
Highway tank truck or trailer	1000 (3000)	11.0+ (7.0+)	6.0 (3.8)	5.0 (3.3)	11.0+ (7.0+)	7.9 (5.1)	6.0 (3.9)
Multiple ton cylinders	500 (1500)	5.2 (3.3)	2.2 (1.4)	1.7 (1.1)	7.4 (4.3)	4.0 (2.5)	2.7 (1.7)
Multiple small cylinders or single ton cylinder	200 (600)	3.1 (1.9)	1.5 (0.9)	1.1 (0.7)	5.6 (3.5)	2.4 (1.5)	1.5 (0.9)

TABLE 3

"+" means distance can be larger in certain atmospheric conditions

ERG2024 USER'S GUIDE

For the purposes of this guidebook, the terms hazardous materials/dangerous goods are synonymous.

The 2024 Emergency Response Guidebook (ERG2024) was developed jointly by Transport Canada (TC), the U.S. Department of Transportation (DOT), and the Secretariat of Infrastructures, Communications and Transport of Mexico (SICT), with help from CIQUIME (Centro de Información Química para Emergencias) of Argentina.

This guidebook is for firefighters, police and other emergency services personnel who may be first to arrive at the scene of a transportation incident involving dangerous goods.

It is primarily a guide to help first responders to quickly:

- **identify the specific or generic hazards of material(s) involved in a transportation incident**
- **protect themselves and the general public during the initial response phase of the incident**

For the purposes of this guidebook, “initial response phase” is the period after first responders arrive at the scene of an incident. During this phase, responders:

- confirm the presence and/or identification of dangerous goods
- start taking protective action and securing the area
- request the help of qualified personnel

This guide is designed for use at a dangerous goods incident on a highway or railroad. It may have limited value at fixed-facility locations, or onboard aircrafts or vessels.

This guide **does not:**

- provide information on the physical or chemical properties of dangerous goods
- replace emergency response training, knowledge, or sound judgment
- address all possible circumstances that may be associated with a dangerous goods incident

ERG2024 incorporates dangerous goods lists from the most recent United Nations Recommendations, and from other international and national regulations.

Explosives are not listed individually (by either proper shipping name or ID number) but, under the general heading “Explosives”, they do appear:

- at the beginning of the ID Number index (yellow section)
- alphabetically in the Name of Material index (blue section)

Chemical and biological warfare agents are now found in the “Criminal or Terrorist Use of Chemical, Biological and Radiological Agents” section.

The letter **(P)** following the guide number in the yellow and blue sections identifies materials that present a polymerization hazard under certain conditions. For example: UN1092 - Acrolein, stabilized GUIDE **131P**.

First responders at the scene of a dangerous goods incident should not solely rely on this guidebook. Always seek specific information about any material in question as soon as possible. To do so:

- Contact the appropriate emergency response agency listed on the inside back cover.
- Call the emergency response telephone number on the shipping paper.
- Consult information on or accompanying the shipping paper.

BEFORE AN EMERGENCY – BECOME FAMILIAR WITH THIS GUIDEBOOK! In the U.S., according to the requirements of the U.S. Department of Labor's Occupational Safety and Health Administration (OSHA, 29 CFR 1910.120) and regulations issued by the U.S. Environmental Protection Agency (EPA, 40 CFR Part 311), first responders must be trained in how to use this guidebook.

GUIDEBOOK CONTENTS

1- Yellow section: Index list of dangerous goods in order of ID number. The list displays the 4-digit ID followed by its assigned emergency response guide and material name.

For example:

ID No.	GUIDE No.	Name of Material
1090	127	Acetone

2- Blue section: Index list of dangerous goods in alphabetical order of material name. The list displays the name followed by its assigned emergency response guide and 4-digit ID number.

For example:

Name of Material	GUIDE No.	ID No.
Sulfuric acid	137	1830

3- Orange section: All safety recommendations are provided here. It is made up of 62 individual guides. Each guide recommends safety and emergency response procedures to protect yourself and the public. Each guide applies to a group of materials with similar chemical and toxicological characteristics. The guide title identifies the general hazards of the dangerous goods.

For example: GUIDE 124 - **Gases - Toxic and/or Corrosive - Oxidizing.**

Each guide is divided into 3 main sections:

POTENTIAL HAZARDS:

- Displays the hazards in terms of **FIRE OR EXPLOSION** and **HEALTH** effects upon exposure.
- Primary potential hazard is listed first.
- Consult this section first to help you make decisions about how to protect the emergency response team and surrounding population.

PUBLIC SAFETY:

- Provides general information on initial precautionary measures to be taken by those first on scene.
- Provides general guidance on **PROTECTIVE CLOTHING** requirements and respiratory protection.
- Lists suggested **EVACUATION** distances for immediate precautionary measures, spills, and for fires (fragmentation hazard).
- When the material is highlighted in green in the yellow and blue sections, it directs the reader to consult Table 1, which lists Toxic Inhalation Hazard (TIH) (PIH in the U.S.) materials and water-reactive materials (green section).

EMERGENCY RESPONSE:

- Outlines special precautions for incidents that involve **FIRE**, **SPILL OR LEAK** or chemical exposure.
- Lists several recommendations under each part to further assist your decision-making process.
- Provides specific **FIRST AID** guidance to use for a product or a guide in addition to the general first aid guidance for hazardous materials/dangerous goods incidents. General first aid guidance is found in the “General First Aid” section situated immediately after the “How to use the Orange Guides” section.

4- Green section: This section has 3 tables.

Table 1 - Initial Isolation and Protective Action Distances

Lists, by order of ID number:

- TIH (PIH in the U.S.) materials
- water-reactive materials which produce toxic gases upon contact with water

These materials are highlighted in green in the yellow and blue sections so you can easily identify them.

Table 1 provides two types of recommended safety distances: “**initial isolation distances**” and “**protective action distances**” for:

- **small spills:** 208 liters (55 US gallons) or less
- **large spills:** more than 208 liters (55 US gallons)

Within the “**initial isolation distance**”, protective clothing and respiratory protection is required. You should consider evacuating all people **in all directions** from the spill or leak source. This distance defines the radius of the “initial isolation zone” surrounding the spill in which people may be exposed to:

- dangerous concentrations upwind of the source
- life-threatening concentrations downwind of the source

The “**protective action distances**” are downwind distances from the spill or leak source, within which responders could carry out protective actions to:

- preserve the health and safety of emergency responders and the public
- evacuate and/or shelter-in-place people in this area (For more information, consult the “Protective Actions” section)

The “protective action distance” is divided into **daytime** and **nighttime** incidents because varying atmospheric conditions affect a hazardous area’s size. In fact, the quantity or concentration of the material’s vapor poses problems, not its mere presence. During the night, the air is generally calmer. This causes the vapor to disperse less and therefore creates a greater toxic zone. In daytime, the atmosphere is more active, so the vapor disperses more. As a result, there is a lower concentration of vapor in the surrounding air and the area that reaches toxic levels is smaller. Daytime is after sunrise and before sunset. Nighttime is between sunset and sunrise.

For example, in the case of a small spill of UN1955 - compressed gas, toxic, n.o.s., the “**initial isolation distance**” is 150 meters (500 feet); therefore its “initial isolation zone” is 300 meters (1000 feet) in diameter. Its “**protective action distance**” is 1.0 kilometer (0.6 miles) for daytime and 3.9 kilometers (2.4 miles) for nighttime.

Note 1: Some water-reactive materials have 2 entries in Table 1. They are identified by (**when spilled on land**) since they are TIH products and (**when spilled in water**) because they produce additional toxic gases when spilled in water.

For example: UN1746 - Bromine trifluoride and UN1836 - Thionyl chloride.

Note 2: If a water-reactive material only has one entry in Table 1 for (**when spilled in water**) and the product is NOT spilled in water, Table 1 and Table 2 do not apply. You will find safe distances in the appropriate orange guide.

For example: UN1183 - Ethyldichlorosilane and UN1898 – Acetyl iodide.

Table 2 - Water-Reactive Materials Which Produce Toxic Gases

Lists:

- by order of ID number, materials which produce large amounts of Toxic Inhalation Hazard (TIH) gases when spilled in water; and
- TIH gases produced by these materials.

You can easily identify water-reactive materials in **Table 1**, as their names are immediately followed by **(when spilled in water)**.

NOTE: The TIH gases indicated in Table 2 are for information purposes only. These TIH gases have already been taken into consideration in the distances of Table 1.

For example, Table 2 indicates that UN1689 sodium cyanide, solid, when spilled in water, will generate hydrogen cyanide gas (HCN). In Table 1, you must refer to the distances for sodium cyanide, solid and not the distances for hydrogen cyanide gas.

Table 3 - Initial Isolation and Protective Action Distances for Large Spills for Different Quantities of Six Common TIH Gases

Lists the following 6 most common TIH materials:

- UN1005 - Ammonia, anhydrous
- UN1017 - Chlorine
- UN1040 - Ethylene oxide and UN1040 - Ethylene oxide with nitrogen
- UN1050 - Hydrogen chloride, anhydrous and UN2186 - Hydrogen chloride, refrigerated liquid
- UN1052 - Hydrogen fluoride, anhydrous
- UN1079 - Sulfur dioxide/Sulphur dioxide

Table 3 shows:

- initial isolation and protective action distances for large spills (more than 208 liters or 55 US gallons)
- different container types (therefore different volume capacities) for daytime and nighttime, and for three different wind speeds (low, moderate and high)

HOW TO CHOOSE THE APPROPRIATE ISOLATION AND PROTECTIVE ACTION DISTANCES

ERG2024 lists isolation or evacuation distances in 2 places:

- the individual guides (orange section)
- Table 1 – Initial Isolation and Protective Action Distances (green section)

If you are dealing with a **non-TIH material** (not highlighted in green in the yellow or blue section),

- Go to the assigned guide for the material (orange section).
- Under **EVACUATION**, you will find:
 - initial isolation distance as an immediate precautionary measure
 - specific distances for spill or fire situations (fragmentation hazard)
 - **Please note** that certain guides may also refer to Table 1. This is just a reminder for green highlighted materials only.

If you are dealing with a **TIH** or **water-reactive** material (green highlighted entries in the yellow or blue section):

If there is no fire:

- Go directly to Table 1 – Initial Isolation and Protective Action Distances (green section).
- Also, consult the assigned guide for the material (orange section).

If a fire is involved:

- Go directly to the assigned guide (orange section) and apply the distances found under **EVACUATION** - Fire.
- Also, consult Table 1 distances for residual material release.

PROTECTIVE CLOTHING

STREET CLOTHING AND WORK UNIFORMS

These garments, such as uniforms worn by police and emergency medical services personnel, provide almost no protection from the harmful effects of hazardous materials/dangerous goods.

STRUCTURAL FIREFIGHTERS' PROTECTIVE CLOTHING (SFPC)

This category of clothing, often called turnout or bunker gear, is the protective clothing firefighters normally wear during structural firefighting operations. It includes a helmet, coat, pants, boots, gloves and a hood to cover parts of the head that are not protected by the helmet and facepiece. It can be used with full-facepiece positive pressure self-contained breathing apparatus (SCBA). It should, at minimum, meet the OSHA Fire Brigades Standard (29 CFR 1910.156) or NFPA 1851.

Structural firefighters' protective clothing provides limited protection from heat and cold. It may not provide adequate protection from harmful vapors or liquids encountered during hazardous materials/dangerous goods incidents.

Each guide includes a statement about the use of SFPC in incidents involving the materials referenced by that guide. Some guides state that SFPC provides limited protection. In those cases, the responder wearing SFPC and SCBA may be able to perform a quick "in-and-out" operation. However, this type of operation can place the responder at risk of exposure, injury or death. The incident commander makes the decision to do this only if there is an overriding benefit (for example, to perform an immediate rescue, turn off a valve to control a leak, etc.).

Please note that the coverall-type protective clothing customarily worn to fight fires in forests or wildlands is not SFPC and **is not** recommended nor referred to elsewhere in this guidebook.

POSITIVE PRESSURE SELF-CONTAINED BREATHING APPARATUS (SCBA)

This apparatus provides a constant, positive pressure flow of air within the facepiece.

You should always use an SCBA certified by NIOSH and the Department of Labor/Mine Safety and Health Administration, in accordance with:

- 42 CFR Part 84
- requirements for respiratory protection specified in OSHA 29 CFR 1910.134 (Respiratory Protection) and/or 29 CFR 1910.156 (f) (Fire Brigades Standard)
- NFPA 1852

Chemical-cartridge respirators or other filtering masks are not acceptable substitutes for positive pressure SCBA. Demand-type SCBA does not meet the OSHA 29 CFR 1910.156 (f)(1)(i) of the Fire Brigades Standard.

RESPIRATORS

If you suspect a chemical warfare agent is involved in an incident, use NIOSH-certified respirators with CBRN protection.

N95 respirators are the most common of the seven types of particulate filtering facepiece respirators. This product filters at least 95% of airborne particles (0.3 microns), but is not resistant to oil. N95 filtering facepiece respirators do not protect against gases and vapors.

Powered air-purifying respirators (PAPR) force ambient air through the air-purifying cartridge or filter into the facepiece. A PAPR does not supply oxygen or air from a separate source (e.g., cylinders).

CHEMICAL PROTECTIVE CLOTHING AND EQUIPMENT

For you to safely use this type of protective clothing and equipment, you need specific skills developed through training and experience. This type of special clothing may protect against one chemical but be readily permeated by chemicals for which it was not designed. Therefore, do not use this type of protective clothing unless it is compatible with the released material. Also, be aware that it offers little or no protection against heat and/or cold.

Examples of this type of equipment have been described as:

- (1) Vapor Protective Suits (NFPA 1991), also known as Totally-Encapsulating Chemical Protective Suits or Level A* protection (OSHA 29 CFR 1910.120, Appendix A & B)
- (2) Liquid-Splash Protective Suits (NFPA 1992), also known as Level B* or C* protection (OSHA 29 CFR 1910.120, Appendix A & B), or suits for chemical/biological terrorism incidents (NFPA 1994), class 1, 2 or 3 Ensembles and Standard CAN/CGSB/CSA-Z1610-11 – Protection of first responders from chemical, biological, radiological, and nuclear (CBRN) events

No single protective clothing material will protect you from all hazardous materials/dangerous goods. Do not assume any protective clothing is resistant to cold and/or heat or flame exposure, unless certified by the manufacturer (NFPA 1991 5-3 Flammability Resistance Test and 5-6 Cold Temperature Performance Test).

*Consult the glossary for more information about protection levels under the heading “Protective Clothing.”

DECONTAMINATION

The ways to decontaminate people and equipment can vary. If you need help with decontamination, contact the emergency response telephone number provided on the shipping papers or the agencies listed on the inside back cover. These resources may be able to put you in contact with the chemical manufacturer to determine the appropriate procedure if not otherwise available.

Decontamination is the process of removing or neutralizing hazardous materials/dangerous goods that have contaminated people and equipment during an incident.

Contamination happens in the area generally referred to as the Hot Zone. Everything and everyone entering this zone should be decontaminated when leaving, including emergency response personnel. This reduces the chances that more contamination will occur.

There are two main types of contamination:

- **Direct contamination** happens in the Hot Zone.
- **Cross contamination** happens when someone or something outside the Hot Zone was not properly decontaminated and comes in contact with another object or person, usually in the Warm or Cold Zone.

To decontaminate, you must:

- physically remove contaminants; and/or
- chemically neutralize contaminants*.

The NFPA 472, Chapter 3, describes the following four kinds of decontamination.

- (1) **Gross decontamination:** Quickly removing surface contamination, which usually happens by mechanically removing the contaminant or rinsing with water from handheld hose lines, emergency showers, or other nearby water sources.
- (2) **Technical decontamination:** Reducing contamination to a level as low as possible by chemical or physical methods. A hazmat team will perform this kind of decontamination.
- (3) **Mass decontamination:** Reducing or removing surface contaminants as fast as possible from a large number of people in potentially life-threatening situations.
- (4) **Emergency decontamination:** Immediately reducing contamination of people in potentially life-threatening situations with or without formally setting up a decontamination corridor. This process should be performed upwind and uphill from victims. Responders should avoid contact with victims, runoff or spray from the decontamination process.

Emergency and mass decontamination can be done with firefighting and rescue operations equipment. Nozzles can be put on wide-angle fog patterns and sprayed towards the ground to create a decontamination shower. Responders can also place nozzles on the discharge ports of engines.

Contaminated clothing and equipment must be removed after use and stored in a controlled area (Warm Zone) until cleanup procedures can begin. Sometimes protective clothing and equipment cannot be decontaminated and must be disposed of properly.

*Chemical neutralization releases heat. DO NOT PERFORM on a victim.

FIRE AND SPILL CONTROL

FIRE CONTROL

Water is the most common and generally most available fire extinguishing agent. Use caution in selecting a fire extinguishing method, as there are many factors to consider. Water may be ineffective in fighting fires that involve some materials.

Fires Involving a Spill of Flammable Liquids

These fires are usually controlled by applying a firefighting foam to the surface of the burning material.

Fighting flammable liquid fires requires:

- foam concentrate that is chemically compatible with the burning material
- correct mixing of the foam concentrate with water and air
- careful application and maintenance of the foam blanket

There are two general types of firefighting foam: regular and alcohol-resistant. Examples of regular foam are protein-base, fluoroprotein, and aqueous film-forming foam (AFFF).

You can control some flammable liquid fires, including many petroleum products, by applying regular foam. Other flammable liquids, including polar solvents (flammable liquids that are water soluble), such as alcohols and ketones, have different chemical properties. You cannot easily control a fire that involves these materials with regular foam, and should use alcohol-resistant foam instead.

Polar solvent fires may be difficult to control and require a higher foam application rate than other flammable liquid fires (see NFPA Standards 11 for further information). Refer to the appropriate guide to determine which type of foam to use. For flammable liquids which have subsidiary corrosive or toxic hazards, it is difficult to make specific recommendations. However, alcohol-resistant foam may be effective for many of these materials.

Contact the emergency response telephone number on the shipping paper, or the appropriate emergency response agency, as soon as possible for guidance on the proper fire extinguishing agent to use.

How you decide to control the fire depends on factors such as:

- incident location
- exposure hazards
- size of the fire
- environmental concerns
- availability of extinguishing agents and equipment at the scene

WATER-REACTIVE MATERIALS

Water is sometimes used to flush spills and reduce or direct vapors in spill situations. Some of the materials covered by this guidebook can react violently or even explosively with water. In these cases, consider letting the fire burn or leaving the spill alone (except to prevent its spreading by diking) until you can get more technical advice.

The applicable guides clearly warn you of these potentially dangerous reactions. Technical advice is required for these materials since:

- Water getting inside a ruptured or leaking container may cause an explosion.
- You may need to cool adjoining containers with water to prevent them from rupturing (exploding), or to prevent the fire spreading further.
- Water may be effective in mitigating an incident involving a water-reactive material, but only if you can apply it at a **sufficient flooding rate for a long period**.
- Products from the reaction with water may be more toxic, corrosive or undesirable than the product that caused the fire.

When you respond to an incident involving water-reactive materials, take into account:

- existing conditions, such as wind, precipitation, location and accessibility to the incident
- availability of agents to control the fire or spill

Because there are variables to consider, base your decision to use water on fires or spills involving water-reactive materials on information from a reliable source. For example, consult the material's manufacturer through the emergency response telephone number or the appropriate emergency response agency listed on the inside back cover.

VAPOR CONTROL

Limiting the amount of vapor released from a pool of flammable or corrosive liquids is an operational concern. It requires proper protective clothing, specialized equipment, appropriate chemical agents and skilled personnel. Before you engage in vapor control, seek advice on tactics to be used from qualified personnel.

There are several ways to minimize the amount of vapors escaping from pools of spilled liquids, such as special foams, adsorbing agents, absorbents, and neutralizing agents. To be effective, you must select a method for the specific material involved, and use it in a way that mitigates, not worsens, the incident.

Where specific materials are known, such as at a manufacturing or storage facilities, the hazardous materials/dangerous goods response team should prearrange with the facility operators to select and stockpile these control agents before a spill.

In the field, first responders may not have the most effective vapor control agent for the material available. They will be more likely to have only water, and only one type of firefighting foam on their vehicles. If the available foam is not appropriate, they will probably use water spray. Because water is being used to form a vapor seal, care must be taken not to churn or further spread the spill during application. Vapors that do not react with water may be directed away from the site using the air currents surrounding the water spray. Before using water spray or other methods to safely control vapor emission or suppress ignition, get technical advice based on a specific chemical name.

LIQUID SPILL CONTROL

Spill control is an important part of any hazardous materials/dangerous goods incident. Spills can have serious health, safety, and environmental consequences. There are many ways to deal with a liquid spill, like:

- diking
- damming, and
- absorbing

A liquid spill can be controlled by setting up a barrier around the spill area. Depending on the product involved, the spill can be contained with either inert or non-combustible absorbent materials.

Inert absorbent materials are granular. The most common types are:

- sand
- diatomaceous earth (a fine powder made from sedimentary rock)
- vermiculite, or
- clay

Non-combustible absorbents are usually not very flammable and can absorb a lot of liquid. These materials are usually made from synthetic materials, like:

- polypropylene
- polyethylene, or
- other synthetic fibers

Other absorbent materials that are easy to find include sawdust or clay litter. Please note the following:

- Sawdust should not be used to absorb flammable liquids or oxidizers since it can catch fire
- Clay litter should not be used to absorb acids since it may contain baking soda, which will react with acids

Before using an absorbent material, get technical advice to confirm its compatibility or test a small amount on the spill.

CONSIDERATIONS FOR LITHIUM BATTERY AND ELECTRIC VEHICLE (EV) FIRES

FIRE CONTROL

Water spray cools batteries and helps suppress and slow the release of toxic gases but does not stop the chemical reaction (thermal runaway). Other extinguishing agents (CO₂, dry chemical, etc.) can trap heat instead of removing it and could result in false (lower temperature) readings.

During an electric vehicle (EV) fire, consult the manufacturer's specific emergency response guide for help with identifying high voltage and medium voltage cabling. **DO NOT CUT THESE CABLES.**

Most electric vehicles have emergency cut loops which are low voltage wire loops that can be cut to disconnect the high voltage system from the rest of the vehicle. If it is safe to do so, follow the manufacturer's directions to disconnect the 12-volt battery. This will isolate the power to the high voltage battery and reduce risk of electric shock.

DAMAGED, DEFECTIVE, OR RECALLED LITHIUM BATTERIES

All lithium batteries can pose a fire risk, whether they are lithium metal or lithium ion, new or used. However, damaged, defective, or recalled (DDR) lithium batteries pose a higher risk than non-DDR lithium batteries because they are more likely to catch fire in a process known as "thermal runaway".

Thermal runaway is a chain reaction that leads to a violent release of stored energy and flammable gas. This reaction can spread to other batteries or combustible materials that are nearby, which could lead to a large-scale thermal event with severe consequences.

Signs that a battery is damaged, defective, or recalled include:

- leaking electrolytes
- swollen or discolored battery casing
- odor or corrosion
- burn marks
- known conditions of use or misuse
- being recalled

BLEVE AND HEAT INDUCED TEAR

BLEVE (BOILING LIQUID EXPANDING VAPOR EXPLOSION)

The following section presents important safety-related information on BLEVEs, including a table, to consider in a situation involving Liquefied Petroleum Gases (LPG), UN1075.

LPGs include the following flammable gases:

- UN1011 - Butane
- UN1012 - Butylene
- UN1055 - Isobutylene
- UN1077 - Propylene
- UN1969 - Isobutane
- UN1978 - Propane

A BLEVE occurs when a fire impinged or damaged tank car fails to contain its internal pressure and explodes with a sudden product release. This catastrophic failure is more likely to occur with damaged pressure tank cars, even in the absence of an active fire.

The **main hazards** from a LPG BLEVE are:

- **Fire:** If the released substance is ignited, there is an immediate fireball.
- **Thermal radiation:** At a distance of about 4 times the radius of a fireball, the heat radiated from a fireball is enough to burn exposed skin in 2 seconds. Wearing protective clothing limits the thermal radiation dose.
- **Blast:** A concussive force caused by the sudden release of the pressurized substance. For a BLEVE occurring out in the open, the blast strength at a distance of 4 times the radius of a fireball can break window glass and may cause minor damage to buildings.
- **Projectiles:** Tank failure can throw metal fragments over large distances. These fragments can and have been deadly.

The danger decreases as you move away from the BLEVE centre. The furthest-reaching hazard is projectiles.

For a video with information on critical safety issues concerning BLEVEs, please visit <https://www.tc.gc.ca/eng/tdg/publications-menu-1238.html>.

HEAT INDUCED TEAR (HIT)

A heat induced tear (HIT) is a rupture of a NON-PRESSURE tank car containing flammable liquids when exposed to the intense heat of a fire. The metal will soften and the pressure in the tank car will increase which can lead to containment failure. The tear generally occurs at the vapor space (upper side) of the container, venting large quantities of flammable liquid and vapors at high speed. A fireball and an intense heat wave will occur.

Compared to BLEVEs, HITs rarely result in the projection of tank car fragments. Heat induced tearing has occurred within 20 minutes of the derailment and as long as 10+ hours following the initial fire.

Responding to these types of incidents (BLEVE and HIT) requires specialized training, equipment and a tactical approach.

BLEVE – SAFETY PRECAUTIONS

Use with caution. The following table gives a summary of tank properties, critical times, critical distances and cooling water flow rates for various tank sizes. This table is provided to give responders some guidance but it should be used with caution.

Tank dimensions are approximate and can vary depending on the tank design and application.

Minimum time to failure is based on *severe torch fire impingement* on the vapor space of a tank in good condition, and is approximate. Tanks may fail earlier if they are damaged or corroded. Tanks may fail minutes or hours later than these minimum times depending on the conditions. It has been assumed here that the tanks are not equipped with thermal barriers or water spray cooling.

Minimum time to empty is based on an engulfing fire with a properly sized pressure relief valve. If the tank is only partially engulfed, then time to empty will increase (i.e., if tank is 50% engulfed, then the tanks will take twice as long to empty). Once again, it has been assumed that the tank is not equipped with a thermal barrier or water spray.

Tanks equipped with thermal barriers or water spray cooling significantly increase the times to failure and the times to empty. A thermal barrier can reduce the heat input to a tank by a factor of ten or more. This means it could take ten times as long to empty the tank through the Pressure Relief Valve (PRV).

Fireball radius and emergency response distance is based on mathematical equations and is approximate. They assume spherical fireballs and this is not always the case.

Two safety distances for public evacuation. The minimum distance is based on tanks that are launched with a small elevation angle (i.e., a few degrees above horizontal). This is most common for horizontal cylinders. The preferred evacuation distance has more margin of safety since it assumes the tanks are launched at a 45 degree angle to the horizontal. This might be more appropriate if a vertical cylinder is involved.

It is understood that these distances are very large and may not be practical in a highly populated area. However, it should be understood that the risks increase rapidly the closer you are to a BLEVE. Keep in mind that the furthest reaching projectiles tend to come off in the zones 45 degrees on each side of the tank ends.

Water flow rate is based on $5(\sqrt{\text{capacity (USgal)}}) = \text{USgal/min}$ needed to cool tank metal.

Warning: the data given are approximate and should only be used with extreme caution. For example, where times are given for tank failure or tank emptying through the pressure relief valve – these times are typical but they can vary from situation to situation. Therefore, never risk life based on these times.

WARNING:

The data given are approximate and should only be used with extreme caution. These times can vary from situation to situation. LPG tanks have been known to BLEVE within minutes. Therefore, never risk life based on these times.

BLEVE (USE WITH CAUTION)

Capacity		Diameter	Length	Propane Mass	Minimum time to failure for severe torch	Approximate time to empty for engulfing fire	Fireball radius	Emergency response distance	Minimum evacuation distance	Preferred evacuation distance	Cooling water flow rate	
Litres	(Gallons)	Meters (Feet)	Meters (Feet)	Kilograms (Pounds)	Minutes	Minutes	Meters (Feet)	Meters (Feet)	Meters (Feet)	Meters (Feet)	Litres/min	USgal/min
100	(26.4)	0.3 (1)	1.5 (4.9)	40 (88)	4	8	10 (33)	90 (295)	154 (505)	307 (1007)	97	26
400	(106)	0.61 (2)	1.5 (4.9)	160 (353)	4	12	16 (52)	90 (295)	244 (801)	488 (1601)	195	52
2000	(528)	0.96 (3.1)	3 (9.8)	800 (1764)	5	18	28 (92)	111 (364)	417 (1368)	834 (2736)	435	115
4000	(1057)	1 (3.3)	4.9 (16.1)	1600 (3527)	5	20	35 (115)	140 (459)	525 (1722)	1050 (3445)	615	163
8000	(2113)	1.25 (4.1)	6.5 (21.3)	3200 (7055)	6	22	44 (144)	176 (577)	661 (2169)	1323 (4341)	870	230
22000	(5812)	2.1 (6.9)	6.7 (22)	8800 (19401)	7	28	62 (203)	247 (810)	926 (3038)	1852 (6076)	1443	381
42000	(11095)	2.1 (6.9)	11.8 (38.7)	16800 (37038)	7	32	77 (253)	306 (1004)	1149 (3770)	2200 (7218)	1994	527
82000	(21662)	2.75 (9)	13.7 (45)	32800 (72312)	8	40	96 (315)	383 (1257)	1435 (4708)	2200 (7218)	2786	736
140000	(36994)	3.3 (10.8)	17.2 (56.4)	56000 (123459)	9	45	114 (374)	457 (1499)	1715 (5627)	2200 (7218)	3640	962

CRIMINAL OR TERRORIST USE OF CHEMICAL, BIOLOGICAL AND RADIOLOGICAL AGENTS

If you suspect an intentional release of a chemical, biological or radiological agent (CBRN), you should immediately contact your local emergency response authorities (911). Additionally, for CBRN incidents occurring:

- within the United States, call the National Response Center at 1-800-424-8802
- within Canada, call CANUTEC at 613-996-6666 (1-888-226-8832)
- within Mexico, call CENACOM at 555128-0000 extensions 36428, 36422, 36469, 37807, 37810
- in other countries, consult the “24-hour emergency response telephone numbers” section.”

The following is general guidance and does not serve as specialized incident response training. Do not enter the scene without appropriate training and equipment.

Initial actions to consider in a potential CBRN/terrorism event:

- First responders must ensure their own safety.
- Avoid using cell phones, radios, etc. within 100 meters (300 feet) of a suspect device.
- If known, request trained specialist resources.
- Set up incident command upwind and uphill of the area.
- Do **not** touch or move suspicious packages or containers.
- Be cautious about the potential presence of secondary devices (e.g., improvised explosive devices (IEDs)).
- Avoid contamination.
- Limit access to only those responsible for rescue of victims or assessment of unknown materials or devices.
- Evacuate and isolate people who were potentially exposed to hazardous materials/dangerous goods to an area away from the scene, preferably upwind and uphill while avoiding physical contact to the extent possible.
- Isolate contaminated areas and secure the scene for analysis of material.

First responders can use the following information to make an initial assessment of a situation they suspect involves criminal or terrorist use of chemical agents, biological agents and/or radioactive materials (CBRN). To help with this, the following paragraphs have a list of observable indicators that a CB agent or radioactive material has been used or is present. This section ends with a Safe Stand-Off Distance Chart for various threats when improvised explosive devices (IEDs) are involved.

DIFFERENCES BETWEEN A CHEMICAL, BIOLOGICAL AND RADIOLOGICAL AGENT

Chemical and biological agents as well as radioactive materials can be dispersed in the air we breathe, the water we drink, or on surfaces we physically contact. Dispersion methods may be as simple as opening a container or using conventional (garden) spray devices, or as elaborate as detonating an improvised explosive device.

Chemical incidents are characterized by the rapid onset of medical symptoms (in minutes to hours) and easily observed signatures (colored residue, dead foliage, pungent odor, dead insects and animals).

Biological incidents are characterized by the onset of symptoms in hours to days. Typically, there will be no characteristic signatures because biological agents are usually odorless and colorless. Because of the delayed onset of symptoms, the affected area may be greater due to the movement of infected people.

Radiological incidents are characterized by the onset of symptoms, if any, in days to weeks or longer. Typically, there will be no characteristic signatures because radioactive materials are usually odorless and colorless. Specialized equipment is needed to determine the size of the affected area, and if the level of radioactivity is an immediate or long-term health hazard. Because it is impossible to detect radioactivity without special equipment, the affected area may be greater due to the migration of contaminated people.

The most probable sources would not generate enough radiation to kill people or cause severe illness. In a radiological incident generated by a “dirty bomb,” or radiological dispersal device (RDD), in which a conventional explosive is detonated to spread radioactive contamination, the primary hazard is from the explosion. However, certain radioactive materials dispersed in the air could contaminate up to several city blocks, creating fear and possibly panic, and needing potentially costly cleanup.

INDICATORS OF A POSSIBLE CHEMICAL INCIDENT

Dead animals/birds/fish	Not just an occasional road kill, but numerous animals (wild and domestic, small and large), birds, and fish in the same area.
Lack of insect life	If normal insect activity (ground, air, and/or water) is missing, check the ground, water surface or shore line for dead insects. If near water, check for dead fish and/or aquatic birds.
Unexplained odors	Possible odors include fruity, flowery, sharp, pungent, garlic, horseradish-like, bitter almonds, peach kernels, or newly mown hay. The odor is completely out of character with its surroundings.
Unusual numbers of dying or sick people (mass casualties)	Health problems including nausea, disorientation, difficulty in breathing, convulsions, localized sweating, conjunctivitis (reddening of eyes), erythema (reddening of skin) and death.
Pattern of casualties	Casualties will likely be distributed downwind, or if indoors, by the air ventilation system.

Blisters or rashes	Numerous people experiencing unexplained water-like blisters, weals (like bee stings), and/or rashes.
Illness in confined area	Different casualty rates for people working indoors versus outdoors dependent on where the agent was released.
Unusual liquid droplets	Numerous surfaces show oily droplets or film; numerous water surfaces have an oily film (no recent rain).
Different-looking areas	Not just a patch of dead weeds, but trees, shrubs, bushes, food crops, and/or lawns that are dead, discolored, or withered (no current drought).
Low-lying clouds	Low-lying cloud or fog-like condition not consistent with its surroundings.
Unusual metal debris	Unexplained bomb or munitions-like material, especially if it contains a liquid.

INDICATORS OF A POSSIBLE BIOLOGICAL INCIDENT

Unusual numbers of sick or dying people or animals	Any number of symptoms may occur. Casualties may occur hours to days after an incident has occurred. The time required before symptoms are observed is dependent on the agent.
Unscheduled and unusual spray being disseminated	Especially if outdoors during periods of darkness.
Abandoned spray devices	Devices may not have distinct odors.

INDICATORS OF A POSSIBLE RADIOLOGICAL INCIDENT

Radiation Symbols	Containers may display a “propeller” radiation symbol.
Unusual metal debris	Unexplained bomb or munitions-like material.
Heat-emitting material	Material that is hot or seems to emit heat without any sign of an external heat source.
Glowing material	Strongly radioactive material may emit or cause radioluminescence.
Sick people/animals	In very improbable scenarios there may be unusual numbers of sick or dying people or animals. Casualties may occur hours to days or weeks after an incident has occurred. The time required before symptoms are observed is dependent on the radioactive material used, and the dose received. Possible symptoms include skin reddening or vomiting.

PERSONAL SAFETY CONSIDERATIONS

When you approach a scene that may involve CB agents or radioactive materials, the most critical thing to consider is your safety and that of other responders.

Use protective clothing and respiratory protection of an appropriate level of safety. In incidents where you suspect that CBRN materials have been used as weapons, NIOSH-certified respirators with CBRN protection are highly recommended. Be aware that you may not be able to verify or identify CB agents or radioactive materials, especially in the case of biological or radiological agents.

The following actions apply to a chemical, biological or radiological incident. This guidance is general. Responders will need to apply it on a case-by-case basis.

Approach and response strategies:

- Minimize exposure time.
- Maximize the distance between you and the item that is likely to harm you.
- Use cover as protection.
- Wear appropriate personal protective equipment and respiratory protection.
- Identify and estimate the hazard by using the indicators above.
- Isolate the area and secure the scene.
- Isolate and decontaminate potentially contaminated people as soon as possible.
- To the extent possible, take measures to limit the spread of contamination.

In the event of a **chemical** incident, the fading of chemical odors does not necessarily indicate reduced vapor concentrations. Some chemicals deaden the senses, giving you the false perception that the chemical is no longer present.

If there is any indication that an area may be contaminated with **radioactive** materials, including the site of any non-accidental explosion, responders:

- should be equipped with radiation detection equipment
- should have adequate training in how to use this equipment

This equipment should be designed to also alert responders when an unacceptable ambient dose rate or ambient dose has been reached.

DECONTAMINATION MEASURES

For chemical and biological agents: Emergency responders should follow standard decontamination procedures (flush-strip-flush). Mass casualty decontamination should begin as soon as possible by stripping all clothing, and flushing with soap and water. For further information, contact the agencies listed on the inside back cover of this guidebook.

For people contaminated with radioactive material: Take care to minimize the spread of the contamination to the extent possible. Move them to a low radiation area if necessary, and if it can be done safely. Remove their clothing and place it in a clearly marked and sealed receptacle, such as a plastic bag, for later testing. Use decontamination methods described above, but avoid breaking the skin (e.g., vigorous brushing). External radiological contamination on intact skin rarely causes a high enough dose to be a hazard, to either the contaminated individual or the first responders. For this reason, prioritize medical stabilization for a contaminated injured individual.

NOTE: The above information was developed in part by the Department of National Defence (Canada), the U.S. Department of the Army, Aberdeen Proving Ground and the Federal Bureau of Investigation (FBI).

CHEMICAL AND BIOLOGICAL WARFARE AGENTS

Chemical and biological warfare agents do not have an assigned ID number because they are not commercially transported. In an emergency situation, the assigned guide (orange section) will provide guidance for the initial response.

The volumes used for the chemical warfare agents' distances are:

- Small release consists of a discharge up to 2 kg (4.4 lbs.)
- Large release consists of a discharge up to 25 kg (55 lbs.)

Biological Warfare Agents:

Biological agents	Pathogens (bacteria, viruses, etc.) that are dispersed with criminal intent. They can cause disease or death in otherwise healthy humans. Examples: Anthrax, plague, smallpox virus. Refer to GUIDE 158.
Toxins	Poisonous or toxic material from a plant, animal, or bacterial source. Examples: Botulinum toxin, ricin. Refer to GUIDE 152.

Chemical Warfare Agents:

Blister agents (vesicants)	<p>Substances that cause blistering of the skin. Exposure is through liquid or vapor contact with any exposed tissue (eyes, skin, lungs).</p> <p>Examples: Lewisite, Mustard.</p> <p>Symptoms: Red eyes, skin irritation, burning of skin, blisters, upper respiratory damage, cough, hoarseness.</p>
Blood agents	<p>Substances that interfere with cell respiration (the exchange of oxygen and carbon dioxide between blood and tissues).</p> <p>Examples: Arsine, cyanogen chloride, hydrogen cyanide.</p> <p>Symptoms: Respiratory distress, headache, unresponsiveness, seizures, coma.</p>
Choking agents	<p>Substances that cause physical injury to the lungs. Exposure is through inhalation. In extreme cases, membranes swell, and lungs become filled with liquid (pulmonary edema). Death results from asphyxiation.</p> <p>Examples: Diphosgene, phosgene.</p> <p>Symptoms: Irritation to eyes, nose, and throat, respiratory distress, nausea, vomiting, burning of exposed skin.</p>
Incapacitating agents	<p>Materials that make people unable to think clearly or that cause an altered state of consciousness (possibly unconsciousness).</p> <p>Examples: 3-Quinuclidinyl benzilate (Buzz).</p> <p>Symptoms: Hallucinations, confusion, agitation, dilated pupils, blurred vision, dry/flushed skin, diarrhea, elevated heart rate, high blood pressure, elevated temperature.</p>
Nerve agents	<p>Substances that interfere with the central nervous system. Exposure is primarily through contact with the liquid (via skin and eyes) and secondarily through inhalation of the vapor.</p> <p>Examples: Sarin, Tabun, VX.</p> <p>Symptoms: Pinpoint pupils, extreme headache, severe tightness in the chest, dyspnea, runny nose, coughing, salivation, unresponsiveness, seizures.</p>

Tear gas agents	<p>Chemical compounds that temporarily make people unable to function by causing irritation to the eyes, mouth, throat, lungs, and skin.</p> <p>Examples: Bromobenzylcyanide, chloroacetophenone.</p> <p>Symptoms: Excessive tearing, burning eyes, blurred vision, redness of the eyes, burning and irritation to mouth, difficulty swallowing, chest tightness, coughing, choking sensation, skin burns and rash.</p>
Vomiting agents	<p>Chemicals that cause rapid onset of irritation of the eyes, upper airway, and skin, and also nausea and vomiting.</p> <p>Examples: Adamsite, diphenylchloroarsine.</p> <p>Symptoms: Irritation of the eyes, noses, burning in throat, chest tightness, nausea, vomiting, abdominal cramps.</p>

INITIAL ISOLATION AND PROTECTIVE ACTION DISTANCES

Chemical warfare agents	Guide	Initial isolation Meters (Feet)	Small release Kilometers (Miles)	Large release Kilometers (Miles)
Blister agents (vesicants)	153	200 (600)	0.4 (0.3)	1.6 (1.0)
Blood agents	117	400 (1200)	0.9 (0.6)	3.2 (2.0)
Choking agents	125	100 (300)	0.3 (0.2)	1.1 (0.7)
Incapacitating agents	153	1000 (3000)	1.7 (1.1)	7.8 (4.8)
Nerve agents	153	400 (1200)	1.0 (0.6)	4.0 (2.5)
Tear gas agents	159	30 (100)	0.2 (0.1)	0.6 (0.4)
Vomiting agents	153	100 (300)	0.6 (0.4)	1.1 (0.7)









For **biological warfare agents**, refer to the respective Guide for distances.

IMPROVISED EXPLOSIVE DEVICE (IED)

An IED is a “homemade” bomb and/or destructive device used to destroy, incapacitate, harass, or distract. Because they are improvised, IEDs can come in many forms, ranging from a small pipe bomb to a sophisticated device capable of causing massive damage and loss of life.

The following table predicts the damage radius based on the volume or weight of explosive (TNT equivalent) and the type of bomb.

Improvised Explosive Device (IED) SAFE STAND-OFF DISTANCE

Threat Description	Explosives Capacity ¹	Mandatory Evacuation Distance ²	Shelter-in-Place Zone	Preferred Evacuation Distance ³
 Pipe Bomb	2.3 kg 5 lbs	21 m 70 ft	22 - 365 m 71 - 1,199 ft	366+ m 1,200+ ft
 Suicide Bomber	9 kg 20 lbs	34 m 110 ft	35 - 518 m 111 - 1,699 ft	519+ m 1,700+ ft
 Briefcase/Suitcase	23 kg 50 lbs	46 m 150 ft	47 - 563 m 151 - 1,849 ft	564+ m 1,850+ ft
 Car	227 kg 500 lbs	98 m 320 ft	99 - 579 m 321 - 1,899 ft	580+ m 1,900+ ft
 SUV/Van	454 kg 1,000 lbs	122 m 400 ft	123 - 731 m 401 - 2,399 ft	732+ m 2,400+ ft
 Small Delivery Truck	1,814 kg 4,000 lbs	195 m 640 ft	196 - 1,158 m 641 - 3,799 ft	1,159+ m 3,800+ ft
 Container/Water Truck	4,536 kg 10,000 lbs	263 m 860 ft	264 - 1,554 m 861 - 5,099 ft	1,555+ m 5,100+ ft
 Semi-Trailer	27,216 kg 60,000 lbs	475 m 1,570 ft	476 - 2,834 m 1,571 - 9,299 ft	2,835+ m 9,300+ ft

High Explosives (TNT Equivalent)

¹ Based on the maximum amount of material that could reasonably fit into a container or vehicle. Variations possible.

² Governed by the ability of an unreinforced building to withstand severe damage or collapse.

³ Governed by the greater of fragment throw distance or glass breakage/falling glass hazard distance. These distances can be reduced for personnel wearing ballistic protection.
Note that the pipe bomb, suicide bomb, and briefcase/suitcase bomb are assumed to have a fragmentation characteristic that requires greater stand-off distances than an equal amount of explosives in a vehicle.

Improved Explosive Device (IED) SAFE STAND-OFF DISTANCE

Threat Description	LPG Mass / Volume ¹	Fireball Diameter ²	Safe Distance ^{3,4}
Small LPG Tank	9 kg / 19 L 20 lbs / 5 gal	12 m 40 ft	48 m 160 ft
Large LPG Tank	45 kg / 95 L 100 lbs / 25 gal	21 m 69 ft	84 m 276 ft
Commercial/Residential LPG Tank	907 kg / 1,893 L 2,000 lbs / 500 gal	56 m 184 ft	224 m 736 ft
Small LPG Truck	3,630 kg / 7,570 L 8,000 lbs / 2,000 gal	89 m 292 ft	356 m 1,168 ft
Semitanker LPG	18,144 kg / 37,850 L 40,000 lbs / 10,000 gal	152 m 499 ft	608 m 1,996 ft

¹ Based on the maximum amount of LPG that could reasonably fit into a container or vehicle. Variations possible.

² Assuming efficient mixing of the flammable gas with ambient air.

³ Determined by U.S. firefighting practices wherein safe distances are approximately 4 times the flame height.

⁴ This table is for a loaded LPG tank with explosives on the exterior. Note that an LPG tank filled with high explosives would require a significantly greater stand-off distance than if it were filled with LPG.

GLOSSARY

Adsorbed gas	A gas which sticks (adsorbs) to the surface of a solid and porous material (such as activated charcoal) contained within a metal cylinder. This results in an internal cylinder pressure of less than 101.3 kPa at 20°C (14 psi at 68°F) and less than 300 kPa at 50°C (43 psi at 122°F). These pressures are much lower than those of conventional cylinders containing compressed or liquefied gases.
AEGL(s)	Acute Exposure Guideline Level(s), AEGLs represent threshold exposure limits for the general public after a once-in-a-lifetime, or rare, exposure and are applicable to emergency exposure periods ranging from 10 minutes to 8 hours. Three levels AEGL-1, AEGL-2 and AEGL-3 are developed for each of five exposure periods (10 and 30 minutes, 1 hour, 4 hours, and 8 hours) and are distinguished by varying degrees of severity of toxic effects; see AEGL-1, AEGL-2 and AEGL-3.
AEGL-1	AEGL-1 is the airborne concentration (expressed as parts per million or milligrams per cubic meter [ppm or mg/m ³]) of a substance above which it is predicted that the general population, including susceptible individuals, could experience notable discomfort, irritation, or certain asymptomatic, non-sensory effects. However, the effects are not disabling and are transient and reversible upon cessation of exposure.
AEGL-2	AEGL-2 is the airborne concentration (expressed as ppm or mg/m ³) of a substance above which it is predicted that the general population, including susceptible individuals, could experience irreversible or other serious, long-lasting adverse health effects or an impaired ability to escape.
AEGL-3	AEGL-3 is the airborne concentration (expressed as ppm or mg/m ³) of a substance above which it is predicted that the general population, including susceptible individuals, could experience life-threatening health effects or death.
Air-Reactive	See “Pyrophoric”.
Alcohol-resistant foam	A foam that is resistant to polar chemicals such as ketones and esters which may break down other types of foam.
BLEVE	Boiling Liquid Expanding Vapor Explosion
Boil over	A sudden increase in fire intensity associated with the expulsion of burning flammable liquid caused by the boiling of water that has accumulated in the bottom of a tank car.

GLOSSARY

Burn	Refers to either a chemical or thermal burn, the former may be caused by corrosive substances and the latter by liquefied cryogenic gases, hot molten substances, or flames.
Carcinogen	A substance or mixture which induces cancer or increases its incidence.
Category A	An infectious substance that poses a high risk to the health of individuals and/or animals or public health. These substances can cause serious disease and can lead to death. Effective treatment and preventative measures may not be available.
Category B	An infectious substance that poses a low to moderate risk to individuals and/or animals and/or public health. These substances are unlikely to cause serious disease. Effective treatment and preventative measures are available.
CBRN	Chemical, biological, radiological or nuclear agent.
CO₂	Carbon dioxide gas.
Cold zone	Area where the command post and support functions that are necessary to control the incident are located. This is also referred to as the clean zone, green zone or support zone in other documents. (EPA Standard Operating Safety Guidelines, OSHA 29 CFR 1910.120, NFPA 472).
Combustible	In this guidebook, a solid or liquid capable of burning but does not catch fire as easily as a flammable liquid. See "Combustible Liquid".
Combustible liquid	Liquids which have a flash point greater than 60°C (140°F) and below 93°C (200°F). U.S. regulations permit a flammable liquid with a flash point between 38°C (100°F) and 60°C (140°F) to be reclassified as a combustible liquid.

GLOSSARY

Compatibility Group

Letters identify explosives that are deemed to be compatible. The definition of these Compatibility Groups in this Glossary are intended to be descriptive. Please consult the transportation of hazardous materials/dangerous goods or explosives regulations of your jurisdiction for the exact wording of the definitions. Class 1 materials are considered to be “compatible” if they can be transported together without significantly increasing either the probability of an incident or, for a given quantity, the magnitude of the effects of such an incident.

- A Substances which are expected to mass detonate very soon after fire reaches them.
- B Articles which are expected to mass detonate very soon after fire reaches them.
- C Substances or articles which may be readily ignited and burn violently without necessarily exploding.
- D Substances or articles which may mass detonate (with blast and/or fragment hazard) when exposed to fire.
- E & F Articles which may mass detonate in a fire.
- G Substances and articles which may mass explode and give off smoke or toxic gases.
- H Articles which in a fire may eject hazardous projectiles and dense white smoke.
- J Articles which may mass explode.
- K Articles which in a fire may eject hazardous projectiles and toxic gases.
- L Substances and articles which present a special risk and could be activated by exposure to air or water.
- N Articles which contain only extremely insensitive detonating substances and demonstrate a negligible probability of accidental ignition or propagation.
- S Packaged substances or articles which, if accidentally initiated, produce effects that are usually confined to the immediate vicinity.

Control temperature

The maximum temperature at which a temperature-controlled substance can be safely transported. Above this temperature, self-accelerating decomposition or polymerization may occur.

GLOSSARY

Control zones	Designated areas at hazardous materials/dangerous goods incidents, based on safety and the degree of hazard. Many terms are used to describe control zones; however, in this guidebook, these zones are defined as the hot/exclusion/red/restricted zone, warm/contamination reduction/yellow/limited access zone, and cold/support/green/clean zone. (EPA Standard Operating Safety Guidelines, OSHA 29 CFR 1910.120, NFPA 472).
Criticality safety index (CSI)	A number value assigned to packages and overpacks containing fissile materials that limits the number of packages containing fissile materials during transportation.
Cryogenic liquid	A refrigerated, liquefied gas that has a boiling point colder than -90°C (-130°F) at atmospheric pressure or is handled or transported at a temperature equal to or less than -100°C (-148°F).
Decomposition products	Products of a chemical or thermal break-down of a substance.
Decontamination	The removal of hazardous materials/dangerous goods from personnel and equipment to the extent necessary to prevent potential adverse health effects. For more information, consult the "Decontamination" section.
Dry chemical	A preparation designed for fighting fires involving flammable liquids, pyrophoric substances and electrical equipment. Common types contain sodium bicarbonate or potassium bicarbonate.
Edema	The accumulation of an excessive amount of watery fluid in cells and tissues. Pulmonary edema is an excessive buildup of water in the lungs, for instance, after inhalation of a gas that is corrosive to lung tissue.
ERPG(s)	Emergency Response Planning Guideline(s). Values intended to provide estimates of concentration ranges above which one could reasonably anticipate observing adverse health effects; see ERPG-1, ERPG-2 and ERPG-3.
ERPG-1	The maximum airborne concentration below which it is believed nearly all individuals could be exposed for up to 1 hour without experiencing more than mild, transient adverse health effects or without perceiving a clearly defined objectionable odor.
ERPG-2	The maximum airborne concentration below which it is believed nearly all individuals could be exposed for up to 1 hour without experiencing or developing irreversible or other serious health effects or symptoms that could impair an individual's ability to take protective action.

GLOSSARY

ERPG-3	The maximum airborne concentration below which it is believed nearly all individuals could be exposed for up to 1 hour without experiencing or developing life-threatening health effects.
Evacuate	Evacuate aims to protect as many people as possible by removing persons from inside a zone safely. If removal is too risky, sheltering-in-place can also be considered in this zone.
Flammable liquid	A liquid that has a flash point of 60°C (140°F) or lower.
Flash point	Lowest temperature at which a liquid or solid gives off vapor in such a concentration that, when the vapor combines with air near the surface of the liquid or solid, a flammable mixture is formed. Hence, the lower the flash point, the more flammable the material.
Flooding quantities	Minimum of 1900 L/min (500 US gal/min) of water.
Hazard zones (Inhalation Hazard Zones)	HAZARD ZONE A: Gases: LC ₅₀ of less than or equal to 200 ppm, Liquids: V equal to or greater than 500 LC ₅₀ and LC ₅₀ less than or equal to 200 ppm. HAZARD ZONE B: Gases: LC ₅₀ greater than 200 ppm and less than or equal to 1000 ppm, Liquids: V equal to or greater than 10 LC ₅₀ ; LC ₅₀ less than or equal to 1000 ppm and criteria for Hazard Zone A are not met. HAZARD ZONE C: LC ₅₀ greater than 1000 ppm and less than or equal to 3000 ppm. HAZARD ZONE D: LC ₅₀ greater than 3000 ppm and less than or equal to 5000 ppm. Please note: even though the term “zone” is used, hazard zones are not an actual area or distance. How zones are assigned is strictly a function of the lethal concentration 50 (LC ₅₀) of the product. For example, TIH Zone A is more toxic than Zone D.
High expansion foam	Foams that have a high expansion ratio (over 1:200) with a low water content.
Hot zone	Area immediately surrounding a hazardous materials/dangerous goods incident which extends far enough to prevent adverse effects from the released product to personnel outside the zone. This zone is also referred to as exclusion zone, red zone or restricted zone in other documents. (EPA Standard Operating Safety Guidelines, OSHA 29 CFR 1910.120, NFPA 472).
IED	See “Improvised Explosive Device”.
Immiscible	In this guidebook, means that a material does not mix readily with water.

GLOSSARY

Improvised Explosive Device	A bomb that is manufactured from commercial, military or homemade explosives.
Isolate	Isolate indicates a zone of no entry that applies to the public and first responders who are not equipped, trained, and prepared to mitigate the incident.
Large spill	A spill that involves quantities that are greater than 208 liters (55 US gallons). This usually involves a spill from a large package, or multiple spills from many small packages.
LC₅₀	Lethal concentration 50. The concentration of a material administered by inhalation that is expected to cause the death of 50% of an experimental animal population within a specified time. (Concentration is reported in either ppm or mg/m ³).
Mass explosion	Explosion which affects almost the entire load virtually instantaneously.
MAWP	Maximum Allowable Working Pressure: The maximum allowable internal pressure that the tank may experience during normal operations.
mg/m³	Milligrams of a material per cubic meter of air.
Miscible	In this guidebook, means that a material mixes readily with water.
mL/m³	Milliliters of a material per cubic meter of air. (1 mL/m ³ equals 1 ppm).
Mutagen	An agent giving rise to an increased occurrence of mutations in populations of cells and/or organisms. Mutation means a permanent change in the amount or structure of the genetic material in a cell.
Narcotic	A substance which acts as a central nervous system depressor producing effects such as drowsiness, narcosis, reduced alertness, loss of reflexes, lack of coordination, and vertigo. These effects can also be manifested as severe headache or nausea, and can lead to reduced judgment, dizziness, irritability, fatigue, impaired memory function, deficit in perception and coordination, reaction time, or sleepiness.
n.o.s.	These letters refer to “not otherwise specified”. The entries which use this description are generic names such as “Corrosive liquid, n.o.s.” This means that the actual chemical name for that corrosive liquid is not listed in the regulations; therefore, a generic name must be used to describe it on shipping papers.
Noxious	In this guidebook, means that a material may be harmful or injurious to health or physical well-being.

GLOSSARY

Organic peroxide	An organic (carbon-containing) compound having two oxygen atoms joined together. Organic peroxides are thermally unstable chemicals. They may have one or more of the following properties: be liable to explosive decomposition; burn rapidly; be sensitive to impact or friction; react dangerously with other substances.
Oxidizer	A chemical which supplies its own oxygen and which helps other combustible material burn more readily.
P	See "Polymerization".
Packing Group	The Packing Group (PG) is assigned based on the degree of danger presented by the hazardous material/dangerous good: PG I : Great danger PG II : Medium danger PG III : Minor danger
PG	See "Packing Group".
pH	pH is a value that represents the acidity or alkalinity of a water solution. Pure water has a pH of 7. A pH value below 7 indicates an acid solution (a pH of 1 is extremely acidic). A pH above 7 indicates an alkaline solution (a pH of 14 is extremely alkaline). Acids and alkalis (bases) are commonly referred to as corrosive materials.
PIH	Poison Inhalation Hazard. See "TIH".
Polar	A molecule in which one side of the molecule has a partial positive charge while another side has a partial negative charge. Examples includes alcohols and ketones.
Polymerization	A chemical reaction that often produces heat and pressure. Once initiated, the reaction is accelerated by the heat that it produces. The uncontrolled buildup of heat and pressure can cause a fire or an explosion, or can rupture closed containers. The letter (P) following a guide number in the yellow and blue sections identifies a material that may polymerize violently under high temperature conditions or contamination with other products during a transportation incident. It is also used to identify materials that have a strong potential for polymerization in the absence of an inhibitor due to depletion of this inhibitor caused by accident conditions.
ppm	Parts per million. (1 ppm equals 1 mL/m ³).

GLOSSARY

Protective clothing	<p>In this guidebook, protective clothing includes both respiratory and physical protection. One cannot assign a level of protection to clothing or respiratory devices separately. These levels were accepted and defined by response organizations such as U.S. Coast Guard, NIOSH, and U.S. EPA.</p> <p>Level A: SCBA plus totally encapsulating chemical resistant clothing (permeation resistant).</p> <p>Level B: SCBA plus hooded chemical resistant clothing (splash suit).</p> <p>Level C: Full or half-face respirator plus hooded chemical resistant clothing (splash suit).</p> <p>Level D: Coverall, including structural firefighters' protective clothing (SFPC), with no respiratory protection.</p> <p>SCBA: Self-contained breathing apparatus.</p> <p>For more information, consult the "Protective Clothing" section.</p>
Pyrophoric	<p>A material which ignites spontaneously upon exposure to air (or oxygen).</p>
Radiation Authority	<p>As referred to in GUIDES 161 through 166 for radioactive materials, the Radiation Authority is either a Federal, state/provincial agency or state/province designated official. The responsibilities of this authority include evaluating radiological hazard conditions during normal operations and during emergencies. If the identity and telephone number of the authority are not known by emergency responders, or included in the local response plan, the information can be obtained from the agencies listed on the inside back cover. They maintain a periodically updated list of radiation authorities.</p>
Radioactivity	<p>The property of some substances to emit invisible and potentially harmful radiation.</p>
Refrigerated liquid	<p>See "Refrigerated liquefied gas".</p>
Refrigerated liquefied gas	<p>A gas which when packaged for transport is made partially liquid because of its low temperature. See "Cryogenic liquid".</p>
Respiratory sensitizer	<p>A substance that induces hypersensitivity of the airways following inhalation of the substance.</p>
Right-of-way	<p>A defined area on a property containing one or more high-pressure natural gas pipelines.</p>
Self-heating material	<p>Material that may spontaneously ignite or generate heat on contact with oxygen (in air) after long periods of time (hours or days).</p>

GLOSSARY

Self-reactive material	Material that is thermally unstable and produces heat upon decomposition, even without participation of air.
Shelter-in-place	People should seek shelter inside a building and remain inside until the danger passes. Sheltering-in-place is used when evacuating the public would cause greater risk than staying where they are, or when an evacuation cannot be performed. Direct the people inside to close all doors and windows and to shut off all ventilating, heating and cooling systems. In-place protection (shelter-in-place) may not be the best option if (a) the vapors are flammable; (b) if it will take a long time for the gas to clear the area; or (c) if buildings cannot be closed tightly. Vehicles can offer some protection for a short period if the windows are closed and the ventilating systems are shut off. Vehicles are not nearly as effective as buildings for in-place protection.
Skin corrosion	The production of irreversible damage to the skin following the application of a test substance for up to 4 hours.
Skin irritation	The production of reversible damage to the skin following the application of a test substance for up to 4 hours.
Skin sensitizer	A substance that will induce an allergic response following skin contact.
Small spill	A spill that involves quantities that are 208 liters (55 US gallons) or less. This generally corresponds to a spill from a single small package (for example, a drum), a small cylinder, or a small leak from a large package.
Specific gravity	Weight of a substance compared to the weight of an equal volume of water at a given temperature. Specific gravity less than 1 indicates a substance is lighter than water; specific gravity greater than 1 indicates a substance is heavier than water.
Spontaneously combustible material	In this guidebook, a spontaneously combustible material means a pyrophoric (air-reactive) material or self-heating material. Refer to each term in the glossary.

GLOSSARY

Straight or solid streams	Method used to apply or distribute water from the end of a hose. The water is delivered under pressure for penetration. In an efficient stream, approximately 90% of the water passes through an imaginary circle 38 cm (15 inches) in diameter at the breaking point. Hose solid streams are typically created by passing water through a non-adjustable bore tip. On the other hand, hose straight streams originate from fog nozzles that are dialed into a straight stream. Hose (solid or straight) streams are frequently used to cool tanks and other equipment exposed to flammable liquid fires, or for washing burning spills away from danger points. However, these streams will cause a spill fire to spread if improperly used or when directed into open containers of flammable and combustible liquids.
Thermal runaway	A chain reaction that leads to a violent release of stored energy and flammable gas. This reaction can spread to other batteries or combustible materials that are nearby, which could lead to a large-scale thermal event with severe consequences.
TIH	Toxic Inhalation Hazard. Term used to describe gases and volatile liquids that are toxic when inhaled (same as PIH). These materials pose a known hazard to human health during transport or is presumed to be toxic to humans because of animal-based studies.
V	Saturated vapor concentration in air of a material in mL/m ³ (ppm) at 20°C and standard atmospheric pressure.
Vapor density	Weight of a volume of pure vapor or gas (with no air present) compared to the weight of an equal volume of dry air at the same temperature and pressure. A vapor density less than 1 (one) indicates that the vapor is lighter than air and will tend to rise. A vapor density greater than 1 (one) indicates that the vapor is heavier than air and may travel along the ground.
Vapor pressure	Pressure at which a liquid and its vapor are in equilibrium at a given temperature. Liquids with high vapor pressures evaporate rapidly.
Viscosity	Measure of a liquid's internal resistance to flow. This property is important because it indicates how fast a material will leak out through holes in containers or tanks.

GLOSSARY

Warm zone	Area between Hot and Cold zones where personnel and equipment decontamination and hot zone support take place. It includes control points for the access corridor and thus assists in reducing the spread of contamination. Also referred to as the contamination reduction corridor (CRC), contamination reduction zone (CRZ), yellow zone or limited access zone in other documents. (EPA Standard Operating Safety Guidelines, OSHA 29 CFR 1910.120, NFPA 472).
Water insoluble	A substance that does not easily dissolve in water.
Water-Reactive Material	In this guidebook, a material which produces a large amount of toxic gas when it comes in contact with water.
Water-sensitive	Substances which may produce flammable, toxic and/or corrosive decomposition products upon contact with water.
Water soluble	A substance that easily dissolves in water. Polar substances are generally soluble in water.
Water spray (fog)	<p>Method or way to apply or distribute water. The water is finely divided to provide for high heat absorption. Water spray patterns can range from about 10 to 90 degrees. Water spray streams can be used to extinguish or control the burning of a fire or to provide exposure protection for personnel, equipment, buildings, etc. This method can be used to absorb vapors, knock-down vapors or disperse vapors. Direct a water spray (fog), rather than a straight or solid stream, into the vapor cloud to accomplish any of the above.</p> <p>Water spray is particularly effective on fires of flammable liquids and volatile solids having flash points above 37.8°C (100°F).</p> <p>Regardless of the above, water spray can be used successfully on flammable liquids with low flash points. The effectiveness depends particularly on the method of application. With proper nozzles, even gasoline spill fires of some types have been extinguished when coordinated hose lines were used to sweep the flames off the surface of the liquid. Furthermore, water spray carefully applied has frequently been used with success in extinguishing fires involving flammable liquids with high flash points (or any viscous liquids) by causing frothing to occur only on the surface, and this foaming action blankets and extinguishes the fire.</p>

PUBLICATION DATA

The 2024 Emergency Response Guidebook (ERG2024) was prepared by the staff of Transport Canada, the U.S. Department of Transportation, and the Secretariat of Infrastructures, Communications and Transport (SICT) of Mexico with the assistance of many interested parties from government and industry including the collaboration of CIQUIME of Argentina. Printing and publication services are provided through U.S. DOT's Pipeline and Hazardous Materials Safety Administration (PHMSA), Outreach, Engagement, and Grants Division.

ERG2024 is based on earlier Transport Canada, U.S. DOT, and Mexico's Secretariat of Infrastructures, Communications and Transport emergency response guidebooks. ERG2024 is published in three languages: English, French and Spanish. The Emergency Response Guidebook has been translated and printed in other languages, including Mandarin, German, Hebrew, Japanese, Portuguese, Korean, Hungarian, Polish, Turkish and Thai.

We encourage countries that wish to translate this Guidebook to please contact any of the websites or telephone numbers in the next paragraph.

DISTRIBUTION OF THIS GUIDEBOOK

The primary objective is to place one copy of the ERG2024 in each publicly owned emergency service vehicle through distribution to Federal, state, provincial and local public safety authorities. The distribution of this guidebook is being accomplished through the voluntary cooperation of a network of key agencies. Emergency service organizations that have not yet received copies of ERG2024 should contact the respective distribution center in their country, state or province. In the U.S., information about the distribution center for your location may be obtained from the Office of Hazardous Materials Safety website at <https://www.phmsa.dot.gov/hazmat/erg/emergency-response-guidebook-erg> or call 202-366-4900. In Canada, contact CANUTEC at 1-613-992-4624 or via the website at <https://tc.canada.ca/en/dangerous-goods/canutec> for information. In Mexico, call SICT at +52 55-57-23-93-00 ext. 20010, 20119, and 20250, or via email at sabundiz@sct.gob.mx and jose.rayon@sct.gob.mx. In Argentina, call CIQUIME at +54-11-5199-1409, or via the website at <https://www.ciquime.org> or via email at gre@ciquime.org.

REPRODUCTION AND RESALE

Copies of this document which are provided free-of-charge to fire, police and other emergency services may not be resold. ERG2024 may be reproduced without further permission subject to the following:

The names and the seals of the participating governments may not be reproduced on a copy of this document unless that copy accurately reproduces the entire content (text, format, and coloration) of this document without modification. In addition, the publisher's full name and address must be displayed on the outside back cover of each copy, replacing the wording placed on the center of the back cover.

Constructive comments concerning ERG2024 are solicited; in particular, comments concerning its use in handling incidents involving hazardous materials/dangerous goods. Comments should be addressed to:

In Canada:

CANUTEC
Transport Canada
330 Sparks Street
Place de Ville, Tower C
14th floor
Ottawa, Ontario
Canada K1A 0N5

Phone: 613-992-4624 (information)

Email: canutec@tc.gc.ca

In the U.S.:

U. S. Department of Transportation
Pipeline and Hazardous Materials Safety Administration
Outreach, Engagement, and Grants Division (PHH-50)
Washington, DC 20590-0001

Phone: 202-366-4900

Fax: 202-366-7342

Email: ERGComments@dot.gov

In Mexico:

Secretaría de Infraestructura, Comunicaciones y Transportes
Dirección General de Autotransporte Federal
Dirección General Adjunta de Normas y Especificaciones
Técnicas y de Seguridad en el Autotransporte
Calzada de las Bombas No. 411-2 piso,
Col. Los Girasoles,
Alcaldía de Coyoacán,
Código Postal 04920,
Ciudad de México

Phone: +52 55-57-23-93-00 ext. 20010, 20119, and 20250

Email: asanchzt@sct.gob.mx, sabundiz@sct.gob.mx, jose.rayon@sct.gob.mx

In Argentina:

Centro de Información Química para Emergencias (CIQUIME)
Av. Alvarez Thomas 636
C1427CCT Buenos Aires, Argentina
Phone: +54-11-5199-1409
Email: gre@ciquime.org

The Emergency Response Guidebook is normally revised and reissued every four years. However, in the event of a significant mistake, omission or change in the state of knowledge, special instructions to change this guidebook (in pen-and-ink, with paste-over stickers, or with a supplement) may be issued.

Users of this guidebook should check periodically (about every 6 months) to make sure their version is current. Changes should be annotated below. Contact:

DOT/PHMSA

<https://www.phmsa.dot.gov/hazmat/erg/emergency-response-guidebook-erg>

TRANSPORT CANADA

<https://tc.canada.ca/en/dangerous-goods/canutec>

CIQUIME

<https://www.ciquime.org>

This guidebook incorporates changes dated:

NOTES

CANADA AND UNITED STATES NATIONAL RESPONSE CENTERS

For the purposes of this guidebook, the terms hazardous materials/dangerous goods are synonymous.

CANADA

1. CANUTEC

CANUTEC is the **Canadian Transport Emergency Centre** operated by the Transportation of Dangerous Goods Directorate of Transport Canada.

CANUTEC provides a national bilingual (French and English) advisory service and is staffed by professional scientists experienced and trained in interpreting technical information and providing emergency response advice.

**In an emergency, CANUTEC may be called at 1-888-CANUTEC (226-8832)
or collect at 613-996-6666 (24 hours)
*666 cellular (Press Star 666, Canada only)**

In a non-emergency situation, please call the information line at 613-992-4624 (24 hours).

The Transportation of Dangerous Goods Act, 1992 (TDG Act) requires reporting dangerous goods incidents which meet or exceed established reporting criteria listed in the Transportation of Dangerous Goods Regulations (TDG Regulations). For more information, consult the TDG website:

<https://tc.canada.ca/en/dangerous-goods/canutec/reporting-requirements>

2. PROVINCIAL/TERRITORIAL AGENCIES

Although technical information and emergency response assistance can be obtained from **CANUTEC**, there are federal, provincial and territorial regulations requiring the reporting of dangerous goods incidents to certain authorities.

The following list of provincial/territorial agencies is supplied for your convenience.

Province	Emergency Authority and/or Telephone Number
Alberta	Local Police and Provincial Authority 1-800-272-9600
British Columbia	Local Police and Provincial Authority 1-800-663-3456
Manitoba.....	Local Police or Fire Department and Provincial Authority 1-855-944-4888
New Brunswick.....	Local Police or Provincial Authority 1-800-565-1633
Newfoundland and Labrador	Local Police and Provincial Authority 1-800-563-9089
Northwest Territories	Local Police and Provincial Authority 1-867-920-8130
Nova Scotia	Local Police or Provincial Authority 1-800-565-1633
Nunavut	Local Police and Provincial Authority 1-867-920-8130
Ontario.....	Local Police and Provincial Authority 1-800-268-6060
Prince Edward Island.....	Local Police or Provincial Authority 1-800-565-1633
Quebec.....	Local Police and Provincial Authority 1-866-694-5454
Saskatchewan	Local Police and Provincial Authority 1-800-667-7525
Yukon	Local Police and Provincial Authority 1-867-667-7244

3. EMERGENCY RESPONSE ASSISTANCE PLANS (Applies in Canada ONLY)

An ERAP or Emergency Response Assistance Plan is a Transport Canada approved plan that describes what is to be done in the event of a transportation incident involving certain high-risk dangerous goods that require specialized emergency response personnel and equipment.

Once implemented, a plan can be used to assist local emergency responders either remotely or on site, by offering technical and emergency response advice and resources. ERAP resources are often integrated with plans from carriers and local or provincial authorities to help mitigate the consequences of an incident.

For shipments that require an ERAP, an ERAP reference number and telephone number to obtain assistance will be included on the shipping paper. Anyone can call the ERAP telephone number. If additional information is required, or to determine if the product involved in the emergency requires an ERAP, contact **CANUTEC**.

**CANUTEC may be called at 1-888-CANUTEC (226-8832)
or collect at 613-996-6666 (24 hours)
*666 on cellular phone (Press star 666) In Canada Only**

NATIONAL RESPONSE CENTER (NRC)

The NRC, which is operated by the U.S. Coast Guard, receives reports required when hazardous materials are spilled. After receiving notification of an incident, the NRC will immediately notify the appropriate Federal On-Scene Coordinator and concerned Federal agencies. Federal law requires that anyone who releases into the environment a reportable quantity of a hazardous material (including oil when water is, or may be affected) or a material identified as a marine pollutant, must **immediately** notify the NRC. When in doubt as to whether the amount released equals the required reporting levels for these materials, the NRC should be notified.

CALL NRC (24 hours)

1-800-424-8802

(Toll-free in the U.S., Canada, and the U.S. Virgin Islands)

202-267-2675 in the District of Columbia

Calling the emergency response telephone number, CHEMTREC®, CHEMTEL, INC., INFOTRAC or 3E COMPANY, does not constitute compliance with regulatory requirements to call the NRC.

Scan for U.S. Incident Reporting

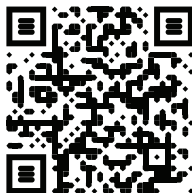

NOTES

24-HOUR EMERGENCY RESPONSE TELEPHONE NUMBERS

MEXICO

1. CENACOM

555128-0000 extensions 36428, 36422, 36469, 37807, 37810

2. CONASENUSA

800-11-131-68 in the Republic of Mexico

3. SETIQ

800-00-21-400 or 55-5559-1588

For calls originating elsewhere, call: +52-55-5559-1588

ARGENTINA

1. CIQUIME

0-800-222-2933 in the Republic of Argentina

For calls originating elsewhere, call: +54-11-4552-8747*

BRAZIL

1. PRÓ-QUÍMICA

0-800-1108270 in Brazil

For calls originating elsewhere, call: +55-19-3833-5310*

COLOMBIA

1. CISPROQUIM

01-800-091-6012 in Colombia

For calls originating in Bogotá, Colombia call: 288-6012

For calls originating elsewhere call: +57-1-288-6012 / +57-1-919-1919

CHILE

1. CITUC QUÍMICO

2-2247-3600 in the Republic of Chile

For calls originating elsewhere call +56-2-2247-3600

* Collect calls are accepted

24-HOUR EMERGENCY RESPONSE TELEPHONE NUMBERS

CANADA

1. CANUTEC

1-888-CANUTEC (226-8832) (in Canada and U.S.)
or **613-996-6666 ***
***666 (STAR 666) cellular** (in Canada only)

UNITED STATES

1. CHEMTREC

1-800-424-9300
(in the U.S., Canada and the U.S. Virgin Islands)
For calls originating elsewhere: **703-527-3887 ***

2. CHEMTEL, INC.

1-888-255-3924
(in the U.S., Canada, Puerto Rico and the U.S. Virgin Islands)
For calls originating elsewhere: **813-248-0573 ***

3. INFOTRAC

1-800-535-5053
(in the U.S., Canada and the U.S. Virgin Islands)
For calls originating elsewhere: **352-323-3500 ***

4. VERISK 3E

1-800-451-8346
(in the U.S., Canada and the U.S. Virgin Islands)
For calls originating elsewhere: **760-602-8703 ***

The emergency response information services shown above maintain periodically updated lists of state and Federal radiation authorities who provide information and technical assistance on handling incidents involving radioactive materials.

5. MILITARY SHIPMENTS, for assistance at incidents involving materials being shipped by, for, or to the Department of Defense (DOD), call one of the following numbers:

703-695-4695/4696 * - Explosives/ammunition incidents
(U.S. Army Operations Center)
1-800-851-8061 - All other hazardous materials/dangerous goods incidents
(Defense Logistics Agency)

6. NATIONWIDE POISON CONTROL CENTER (United States only)

1-800-222-1222

* Collect calls are accepted

A guidebook intended for use by first responders
during the initial phase of a transportation incident
involving hazardous materials/dangerous goods

**THIS DOCUMENT SHOULD NOT BE USED TO
DETERMINE COMPLIANCE WITH THE
HAZARDOUS MATERIALS/
DANGEROUS GOODS REGULATIONS
OR
TO CREATE WORKER SAFETY DOCUMENTS
FOR SPECIFIC CHEMICALS**

NOT FOR SALE

This document is intended for distribution
free of charge to Public Safety Organizations
by the US Department of Transportation and
Transport Canada. This copy may not be
resold by commercial distributors.



U.S. Department of Transportation
Pipeline and Hazardous Materials
Safety Administration



Transport
Canada

Transports
Canada



COMUNICACIONES
SECRETARÍA DE INFRAESTRUCTURA, COMUNICACIONES Y TRANSPORTES

SCAN FOR
U.S. INCIDENT REPORTING



www.phmsa.dot.gov/hazmat

SCAN FOR
CANUTEC



www.tc.gc.ca/TDG

SCAN FOR
SICT



www.sct.gob.mx